



*1-VMD Type2 : Intruder Detection / Loitering Detection / Direction Detection / Scene Change Detection / Object Detection / Cross Line Detection

Full HD / 1,920 x 1,080 60 fps H.264 Vandal Resistant Network Camera featuring Super Dynamic







Key Features

- **1080p** Full HD images up to **60 fps***1
- Approximate 1/3 inches, high sensitivity MOS image sensor
- Super high resolution at Full HD/1,920 x 1,080 created by high sensitivity MOS image sensor.
- **Multiple H.264 (High profile) streams (max. 4 streams)** and JPEG streams ensure simultaneous real time monitoring and high resolution recording.
- Maximum Screen Size is 2,048 x 1,536* @30fps, H.264
* Used by super resolution techniques
- **Enhanced Super Dynamic***1 and ABS (Adaptive Black Stretch) technologies deliver **133 dB** wider dynamic range compared to conventional cameras.
- **Multi process NR & 3D-DNR** ensures noise reduction in various conditions.
- High sensitivity with Day/Night (ICR)* function: 0.07 lx (Color), 0.01 lx (B/W) at F1.6
*ICR: IR Cut filter Removal
- **ABF (Auto Back Focus)** ensures easy installation.
- **VIQS (Variable Image Quality on Specified area)** technology allows the designated **eight areas** to retain higher image quality while the excluded area will have a decreased image quality, which enables to use lower image file size and bit rate.
- Cropping function enables to provide whole image and the part image simultaneously. Up to 4 image capture areas can be specified, and it is also possible to control the sequence.
- **Face Super Dynamic** technology ensures clear face image.
- Lens distortion compensation for the distorted images can be adjusted 256 steps.
- Electronic sensitivity enhancement: Auto (Up to 16/30s) / OFF
- Selectable light control modes:
Outdoor scene, Indoor scene (50 Hz) / Indoor scene (60 Hz), Fix shutter
Indoor scene (50 Hz/60Hz): Flicker caused by fluorescent lightning will be automatically compensated.
- 3x extra optical zoom at 640 x 360 resolution
- 2x, 4x digital zoom controlled by browser
- VMD (Video Motion Detection) with 4 programmable detection areas, 15 steps sensitivity level and 10 steps detection size
- Privacy Zone can mask up to 8 private areas, such as house windows and entrances/exits.
- Camera title display: Up to 20 alphanumeric characters on the browser
- Alarm sources including 3 terminal input, VMD and Panasonic alarm command can trigger actions such as SDXC/SDHC/SD memory recording, FTP image transfer, E-mail notification, Indication on browser, Alarm terminal output, and Panasonic alarm protocol output.
- Full duplex bi-directional audio allows interactive communication between camera site and monitoring site.
- JPEG Image compression ratio can be changed by alarm so that higher quality image can be provided.

- Prioritized stream control: One of the video streams can be prioritized when multiple recorders or client PCs are accessing the camera so that the recorder or the client PC can maintain the frame rate.
- **SDXC/SDHC/SD Memory card slot** for manual recording (H.264 / JPEG), alarm recording (H.264 / JPEG) and backup upon network failure (H.264 / JPEG). Realize long-term recording and auto backup function.
- Face detection function detects the position of human face and the information is sent by XML or video stream. (Optional)
- Can be added new intelligent extension software (Optional) in addition to built-in VMD (Video Motion Detection), alarm function.
- **Fog compensation function** equipped as standard.
- **HLC (High Light Compensation)** technology reduces strong light sources such as vehicle headlights to prevent camera being blinded.
- **SCC (Super Chroma Compensation)** function realizes a better color reproducibility even in low illumination.
- H.264 max. bit rate/client and Total bit rate control allows flexible network traffic management.
Frame rate priority mode controls bit rate and compression ratio to provide the specified frame rate.
- Internet mode: H.264 images can be transmitted over HTTP protocol.
- Multi-language: English / Italian / French / German / Spanish / Portuguese / Russian / Chinese / Japanese
- IPv4/IPv6 protocol supported
- Supports SSL, DDNS (viewnetcam, RFC2136)
- Still images (JPEG) can be viewed on mobile phones via Internet.
- Onvif compliant model
- IP66 rated water and dust resistant. Compatible with IEC60529 measurement standard, Type 4X(UL50), NEMA 4X compliant.
- Dehumidification device for use with various weather conditions
- Vandal resistant mechanism for high reliability

*1 Super Dynamic function is automatically set off on 60 fps mode.

Optional Accessories

Ceiling Mount Bracket WV-Q169A 	Smoke Dome Cover WV-CW7S 	Sun Shade WV-Q7118 	
Ceiling Mount Bracket WV-Q105A 	Ceiling Mount Bracket WV-Q121B 	Wall Mount Bracket WV-Q122A 	Mount Bracket WV-Q124 
<small>* For Indoor installation only</small>			
<small>(Use with the WV-Q124 (suspension mount bracket) to be able to install on a ceiling.)</small>		<small>(Use with the WV-Q124 (suspension mount bracket) to be able to install on a wall.)</small>	
			<small>(Use when installing the WV-SFV531 using the WV-Q122A.)</small>

Specifications

Camera	Image Sensor	Approx. 1/3 type MOS image sensor	
	Scanning Mode	Progressive scan	
	Scanning Area	5.28 mm (H) x 3.30 mm (V) {7/32 inches (H) x 1/8 inches (V)}	
	Minimum Illumination	Color: 0.07 lx, BW: 0.01 lx (F1.6, Maximum shutter: Max. 1/30s, Gain: On(High)) Color: 0.005 lx, BW: 0.0007 lx (F1.6, Maximum shutter: Max. 16/30s, Gain: On(High)) ¹	
	White Balance	AWC (2,000 - 10,000 K), ATW1 (2,700 - 6,000 K), ATW2 (2,000 - 6,000 K)	
	Light Control Mode	Outdoor scene : Automatic integration of ALC and ELC Indoor scene [50 Hz] : Automatic integration of ALC and ELC with flickerless Indoor scene [60 Hz] : Automatic integration of ALC and ELC with flickerless	
	Shutter Speed	[2 mega pixel {16:9}(60 fps mode)] Off(1/60), 1/100, 1/120, 1/250, 1/500, 1/1000, 1/2000, 1/4000, 1/10000 Other than [2 mega pixel {16:9}(60 fps mode)] Off(1/30), 3/100, 3/120, 2/100, 2/120, 1/100, 1/120, 1/250, 1/500, 1/1000, 1/2000, 1/4000, 1/10000	
	Super Dynamic ²	On(High) / On(Normal) / Off	
	Face Super Dynamic	On / Off (Only when Super Dynamic : On)	
	Adaptive Black Stretch	On / Off (Only when Super Dynamic : Off)	
	Fog compensation	On / Off (Only when Super Dynamic/ Adaptive black stretch : Off)	
	AGC	On (Low, Mid, High) / Off	
	Electronic Sensitivity UP	max. 1/1000 s, max. 1/500 s, max. 1/250 s, max. 1/120 s, max. 1/100 s, max. 1/60 s, max. 1/30 s, max. 2/120 s, max. 2/100 s, max. 2/30 s, max. 4/30 s, max. 6/30 s, max. 10/30 s, max. 16/30 s	
	Day/Night (ICR)	Off / On / Auto1 (Normal) / Auto2 (IR Light) / Auto3 (SCC)	
	Dynamic Range	133 dB typ. (Super Dynamic : On, Light Control Mode : indoor)	
	Digital Noise Reduction	High / Low	
	Video Motion Detection	4 areas, Sensitivity : 15 steps, Detection size : 10 steps	
	Privacy Zone	Up to 8 zones	
	VIQS	Up to 8 zones	
	Camera Title (OSD)	Up to 20 characters (alphanumeric characters, marks)	
Focus Adjustment	ABF / MANUAL(Html only)		
Lenr Distortion Compensation	256 steps		
Lens	Vari Focal Length	2.8 - 9.5 mm (1/8 inches - 13/32 inches)	
	Angular Field of View	[16 : 9 mode] Horizontal : 31° (TELE) - 109° (WIDE) Vertical : 18° (TELE) - 59° (WIDE) [4 : 3 mode] Horizontal : 26° (TELE) - 89° (WIDE) Vertical : 20° (TELE) - 66° (WIDE)	
Maximum Aperture Ratio	1 : 1.6 (WIDE) - 1 : 3.3 (TELE)		
Focusing Range	0.3 m - ∞		
Adjusting Angle		Horizontal: ±180°, Vertical: ±85°, Image tilt adjustment range: -100° (Left) to +100° (Right)	
Browser GUI	Cropping	H.264(1) / H.264(2) / H.264(3) / H.264(4) / H.264(all) / JPEG(1) / JPEG(2) / JPEG(3) Up to 4 image capture areas can be specified	
	Camera Control	Brightness, AUX On / Off	
	Display Mode	Spot, Quad : Image from 16 cameras can be displayed in 4 different Quad screens or 16 split screen (JPEG only). 20 characters camera title available.	
	Digital Zoom	1x, 2x, 4x controlled by browser GUI	
	Camera Title	Up to 20 alphanumeric characters	
	Clock Display	Time : 12H/24H, Date : 5 formats on the browser, Summer time (Manual)	
	Alarm Control	Reset	
	One Shot Capture	A still picture will be displayed on a newly opened window.	
	Audio	Mic (Line) Input : On / Off Volume adjustment : Low / Middle / High Audio Output : On / Off Volume adjustment : Low / Middle / High	
	SD Memory Data Download	Still or motion images recorded in the SDXC/SDHC/SD memory card can be downloaded.	
GUI / Setup Menu Language	English, Italian, French, German, Spanish, Portuguese, Russian, Chinese, Japanese		
System Log	Up to 100 (Internal) Up to 4,000 (SDXC/SDHC/SD memory when the recording format is set to JPEG.) error logs		
Supported OS ³	Microsoft® Windows® 8.1, Microsoft® Windows® 8, Microsoft® Windows® 7, Microsoft® Windows Vista®		
Supported Browser	Windows® Internet Explorer® 11 (32-bit), Windows® Internet Explorer® 10 (32-bit), Windows® Internet Explorer® 9 (32-bit), Windows® Internet Explorer® 8 (32-bit), Windows® Internet Explorer® 7 (32-bit)		
Network	Network IF	10Base-T / 100Base-TX, RJ45 connector	
	Image Resolution	• 2 mega pixel [16:9] (30/60 fps) 1,920 x 1,080 / 1,280 x 720 / 640 x 360 / 320 x 180 / 160 x 90 • 2 mega pixel [4:3] (30 fps) 1,600 x 1,200 / 1,280 x 960 / 800 x 600 / 640 x 480 / 400 x 300 / 320 x 240 / 160 x 120 • 3 mega pixel [4:3] (30 fps) 2,048 x 1,536 / 1,280 x 960 / 800 x 600 / 640 x 480 / 400 x 300 / 320 x 240 / 160 x 120 * Used by super resolution techniques	
	H.264 ⁴	Transmission Mode	Constant bitrate / Framerate priority / Best effort / Advanced VBR
		Frame Rate	1 / 3 / 5 / 7.5 / 10 / 12 / 15 / 20 / 30 / 60 fps
		Bit Rate/Client	64 / 128 / 256 / 384 / 512 / 768 / 1,024 / 1,536 / 2,048 / 3,072 / 4,096 / 6,144 / 8,192 / 10,240 / 12,288 / 14,336 / 16,384 / 20,480 / 24,576 kbps
		Image Quality	Low / Normal / Fine
		Refresh Interval	0.2 / 0.25 / 0.33 / 0.5 / 1 / 2 / 3 / 4 / 5s
	JPEG	Transmission Type	Unicast / Multicast
		Image Quality	10 steps
	Audio Compression	Refresh interval	0.1 fps - 30 fps (JPEG frame rate will be restricted when displaying both JPEG and H.264 images.)
		Transmission Type	Pull / Push
		Audio Compression	G.726 (ADPCM) 32 kbps / 16 kbps, G.711 64 kbps / AAC-LC
		Audio Mode	Off / Mic (Line) input / Audio output / Interactive (Half duplex) / Interactive (Full duplex)
		Authentication for Audio	Level 1 only / Level 2 higher / All users
		Total Bit Rate	64 / 128 / 256 / 384 / 512 / 768 / 1,024 / 2,048 / 4,096 / 8,192 kbps / Unlimited
Supported Protocol		IPv6 : TCP/IP, UDP/IP, HTTP, HTTPS, FTP, SMTP, DNS, NTP, SNMP, DHCPv6, RTP, MLD, ICMP, ARP IPv4 : TCP/IP, UDP/IP, HTTP, HTTPS, RTSP, RTP, RTP/RTCP, FTP, SMTP, DHCP, DNS, DDNS, NTP, SNMP, UPnP, IGMP, ICMP, ARP	
FTP Client		Alarm image transmission, FTP periodic transmission (When the FTP transmission is failed, backup on an optional SDXC/SDHC/SD memory card is available.)	

Network	No. of Simultaneous Users	Up to 14 users (Depends on network conditions)
	SDXC/SDHC/SD Memory Card (Option)	H.264 recording : Manual REC / Alarm REC (Pre/Post) / Schedule REC / Backup upon network failure * Use the SD memory card manufactured by Panasonic (SD speed class 4 or higher), and in the case of SD Speed Class 10, that complies with UHS-1(Ultra High Speed-1). JPEG recording : Manual REC / Alarm REC (Pre/Post) / Backup upon network failure Compatible SD (SDHC/SDXC) card : Panasonic 2 GB, 4 GB*, 8 GB*, 16 GB*, 32 GB*, 64GB** model *SDHC card, ** SDXC card (except miniSD card and microSD card)
Alarm	Cellular Phone Compatibility	JPEG image, AUX control (by access level)
	Mobile Terminal Compatibility	iPad, iPhone, iPod touch (iOS 4.2.1 or later), Android™ mobile terminals
Input/ Output	Alarm Source	3 terminals input, VMD, Command alarm, Audio detection alarm
	Alarm Actions	SDXC/SDHC/SD memory recording, E-mail notification, HTTP alarm notification Indication on browser, FTP image transfer, Panasonic protocol output
General	Alarm Log	With SDXC/SDHC/SD memory card : Up to 50,000 logs for each SD memory card
	Schedule	Alarm / VMD / Access permission / H.264 recording / Scene file
	Monitor Output (for adjustment)	VBS : 1.0 V (p-p)/75 Ω, ø3.5mm mini jack MONITOR OUT conversion plug included
	Microphone/Line Input	MIC IN and Line IN are selectable. ø3.5 mm monaural mini jack (monaural input) (Applicable microphone: Plug-in power type) Supply voltage: 2.5 V ±0.5 V Input impedance: Approx. 2 kΩ (unbalanced)
	Audio Output	ø3.5 mm stereo mini jack (monaural output) Output impedance: Approx. 600 Ω (unbalanced)
	External I/O Terminals	ALARM IN 1(DAY/NIGHT IN), ALARM IN 2(ALARM OUT), ALARM IN 3(AUX OUT)
	Safety	UL (UL60950-1), C-UL (CAN/CSA C22.2 No.60950-1), CE, IEC60950-1
	EMS	FCC (Part15 ClassA), ICES003 ClassA, EN55022 ClassB, EN55024
	Power Source and Power Consumption	DC power supply: DC12 V / 750 mA / Approx. 9 W PoE Device: DC48 V / 210 mA / Approx. 10.1 W (Class 0 device) * Maximum power consumption on the camera power input side. ** ONLY CONNECT DC12 V CLASS 2 POWER SUPPLY.
	Ambient Operating Temperature	-40 °C to +50 °C (-40 °F to 122 °F)
Ambient Operating Humidity	10 to 90 % (no condensation)	
Impact Protection	IEC 60068-2-75 test Eh, 50 J / IEC 62262 IK10	
Water and Dust Resistance	IP66, IEC60529 measuring standard compatible, Type 4X(UL50), NEMA 4X compliant	
Shock Resistance	Compliant with 50 J IEC60068-2-75	
Dimensions	ø164 mm x 139 mm (H) (ø6-15/32 inches x 5-15/32 inches (H)) * Installing using the base bracket Dome radius 42 mm (1-21/32 inches)	
Mass (approx.)	With base bracket : Approx. 1.6 kg (3.53 lbs) Without base bracket : Approx. 1.2 kg (2.65 lbs)	
Finish	Main body : Aluminum die cast, light gray Dome section: Clear polycarbonate resin	
Others	Tamper-resistant enclosure ⁵	

- ¹ Converted value
² Super Dynamic function is automatically set off on 60 fps mode.
³ Refer to "Notes on Windows Vista® / Windows® 7 / Windows® 8 / Windows® 8.1" on the provided CD-ROM for further information about system requirements for a PC and precautions when using Microsoft® Windows® 8.1 or Microsoft® Windows® 8 or Microsoft® Windows® 7 or Microsoft® Windows Vista®.
⁴ Transmission for 4 streams can be individually set.
⁵ Component that has a structure on which the screws that are accessible after installation can not be screwed or unscrewed using an ordinary screwdriver.

Part Names and Functions

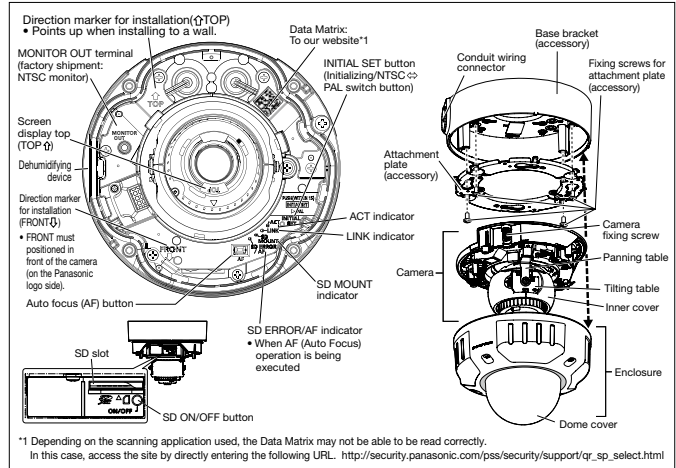

¹ Depending on the scanning application used, the Data Matrix may not be able to be read correctly. In this case, access the site by directly entering the following URL: http://security.panasonic.com/ps/security/support/gr_sp_select.html

Appearance

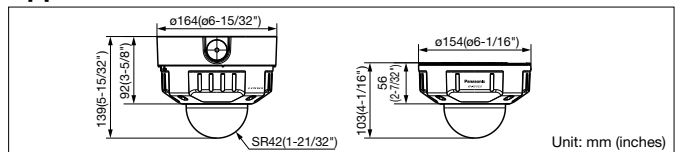

Trademarks and registered trademarks

- Microsoft, and Windows are registered trademarks of Microsoft Corporation in the U.S. and other countries.
- iPad, iPhone and iPod touch are registered trademarks of Apple Inc.
- Android is a trademark of Google Inc.
- "i-PRO SmartHD" logo is trademark or registered trademark of Panasonic Corporation.
- ONVIF and the ONVIF logo are trademarks of ONVIF Inc.

Important

- Safety Precaution: Carefully read the Important Information, Installation Guide and operating instructions before using this product.
- Panasonic cannot be responsible for the performance of the network and/or other manufacturers' products used on the network.
- Masses and dimensions are approximate. • Specifications are subject to change without notice.

DISTRIBUTED BY:

Panasonic

<http://security.panasonic.com>

<http://www.facebook.com/PanasonicNetworkCamera>

(2A-141CA)