

Building automation and control systems

System Catalog 2016



Content

1	System functions	<ul style="list-style-type: none"> - Desigo – the innovative system for highest efficiency and safety in the building - Desigo system topology - System functions for building automation - Trend and history function - Event management - Schedulers/calendar - Access rights - Monitoring functions - Communication – network
2	Management functions	<ul style="list-style-type: none"> - Desigo CC - Desigo Insight - Informationsmanagement
3	Automation controls	<ul style="list-style-type: none"> - Automation stations - Operator units - Desigo TX-I/O
4	Room automation	<ul style="list-style-type: none"> - Desigo TRA - Desigo RX - Room operator units - Service unit
5	Standard controllers	<ul style="list-style-type: none"> - Communicating HVAC controllers – Synco™ 700 - Software and central communication units
6	Room automation Synco	<ul style="list-style-type: none"> - Communicating controllers - RXL (Bus) - Communicating controllers - RXB (KNX) - Communicating room thermostats - Central control unit RMB.. - Room operator units - Damper actuator (KNX) - KNX accessories

A low-angle shot of a modern glass skyscraper. The glass panels reflect a highly detailed, ornate historical building with a central dome and classical architectural elements. The sky is blue with some light clouds. In the foreground, there are green trees with bright sunlight filtering through the leaves.

Can old buildings be just as energy-efficient as new ones?

Intelligent and energy-efficient building technologies from Siemens reduce emissions and costs, in any building.

A comprehensive offering for optimal building efficiency

Dear Customers and Partners,

In many countries, energy generation, distribution and consumption are issues of vital importance and receive top priority. Yet the challenges for the world's energy markets could not be more different: Energy demand in the growth markets is increasing rapidly, but in developed countries the focus is on cost effectiveness and climate protection.

State-of-the-art smart buildings play a key role in the advanced power grids known as smart grids. By expertly combining building technology with energy transmission and distribution, smart grids can significantly improve energy efficiency while reducing greenhouse gas emissions with groundbreaking effect. And the results continue to get better as the buildings are integrated more closely in the grid and as individual disciplines interact more effectively.

Efficient building management, however, goes beyond the aspect of energy. Without a doubt, Desigo CC™ is the next-generation management platform in terms of overall efficiency and scalable operations of a building. As the first-ever management platform of its kind, Desigo CC can integrate all disciplines of a building – from building automation to fire safety and security. This holistic approach enables customers to visualize bottlenecks in different disciplines in real time, to create synergies and to reduce costs.

Wherever possible, our offerings cover efficiency and cost effectiveness throughout the entire life cycle of a building. Extensive reporting and analytics functions provide the basis for sound, forward-looking decisions and actions. Modular system design, compatibility and compliance with standards provide a wide range of flexible customization options and long-term investment protection. Our integrated applications connect all disciplines in a building; our controllers and operator units are intuitive and easy to operate, and our field devices offer impressive engineering efficiency. Workflow-based processes support process-compliant, standardized operations and minimize training time.

Benefit from our comprehensive range of innovative products, systems and tested applications to enhance the efficiency in rooms and to protect the environment. Siemens provides comprehensive support through tools and new apps for smart phones and tablets so that you can quickly find the right product from our extensive product range.

BACS efficiency classes – EN 15232

High energy performance

BACS and TBM

A

Advanced

BACS and TBM

B

Standard

BACS

C

Non-energy-efficient

BACS

D

BACS Building Automation and Control System

TBM Technical Building Management System



Cutting costs through energy efficiency

The best way to lower operating costs is to consume less energy. Intelligent building automation technology from Siemens helps reduce the energy use by as much as 30 percent.

Achieving energy efficiency without sacrificing comfort

Rising energy costs and government regulations are not the only reasons why people are rethinking their energy consumption. Growing awareness of climate change and dwindling resources are other factors why energy efficiency is becoming more and more important in everyday life.

Buildings account for roughly 40 percent of global energy consumption. Examples include residential buildings, office and commercial buildings as well as hotels, shopping centers and industrial buildings.

Lowering energy consumption using intelligent building automation is particularly effective. Improvements to existing building automation systems often require little investments and help save a significant amount of energy, reduce CO₂ emissions and shorten payback periods.

The building management systems from Siemens make it possible to reach efficiency class A under the European Standard EN 15232. As a leading specialist in energy efficiency in buildings, with more than 30 years of experience and an extensive and harmonized portfolio of products, systems and solutions, Siemens is the ideal partner for optimizing efficiency.



Energy-efficient applications

Measurable and sustainable energy savings can be achieved only through control strategies developed on the basis of proven applications. Systems from Siemens are based on an extensive set of innovative functions.

For example, the Desigo™ AirOptiControl application not only ensures good air quality and optimum room temperature but also reduces the required energy demand by as much as 50 percent.

Focus on the room user

With its room automation technology, Siemens not only provides intelligent control but also involves the room users. Actively inviting the participation of users makes it possible to save even more energy. With the Desigo Green Leaf display, users can check at any time whether energy consumption has exceeded the limit values. At the press of a button, users can return the system to optimized operation at any time, thereby contributing to energy efficiency.

Highlights

- Reduction in energy consumption by as much as 30 percent
- Sustainable, efficient control strategies based on established applications
- Additional cost savings by involving room users



Desigo – flexible and energy-efficient

Efficient savings without sacrifices – with the Desigo building management system, you can save a great deal of energy while maintaining a pleasant room climate and optimizing comfort.

Desigo helps lower operating costs and cut energy consumption while maintaining optimum room conditions. You can respond quickly and flexibly to changes in building usage, and your investments are protected over the building's entire life cycle, thanks to features such as centralized, intelligent energy management, highly efficient energy saving functions, and the effective interaction of all system components and processes.

New compact automation stations

The new compact room automation stations DXR2 allow you to automate heating, ventilation, air conditioning, shading and lighting in individual rooms. BACnet/IP and BACnet MS/TP are available as system communication options. The room automation stations DXR2 come with preloaded applications. In addition, an extensive library of tested applications is available. The stations can also be custom-programmed. Switches, sensors and actuators for lighting and shading are integrated via KNX PL-Link.

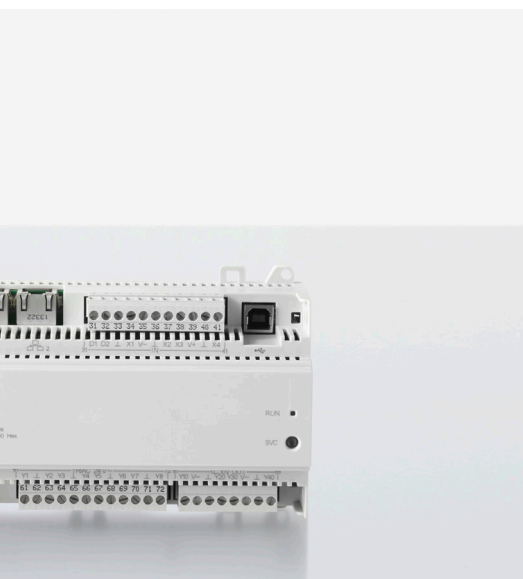

Innovative room operator unit

The IP-enabled room operator unit QMX7 with its intuitive touch-based operating concept and capacitive color display is the newest member of the Desigo TRA family. It offers a sleek, contemporary design, and its scope of functions can be configured as needed to customize the control of room disciplines. The room unit can be combined with the new compact room automation stations, and the Green Leaf symbol actively involves room users in the energy saving process.

New features

Desigo provides support for the latest and future industry and IT standards, including AMEV, BACnet with IPv6 communication and the B-AWS profile for Desigo CC and Desigo Insight as well as the latest 64-bit Windows operating systems. In addition, the latest version is the basis for the Desigo CC management platform with its workflow-guided operating concept and multidisciplinary control and monitoring functionalities.

Highlights

- Reduces operating costs and maximizes investment protection without sacrificing comfort
- New compact room automation station for Desigo TRA and innovative touch room operator unit
- Supports the latest standards for seamless integration
- Extensive range of KNX room units

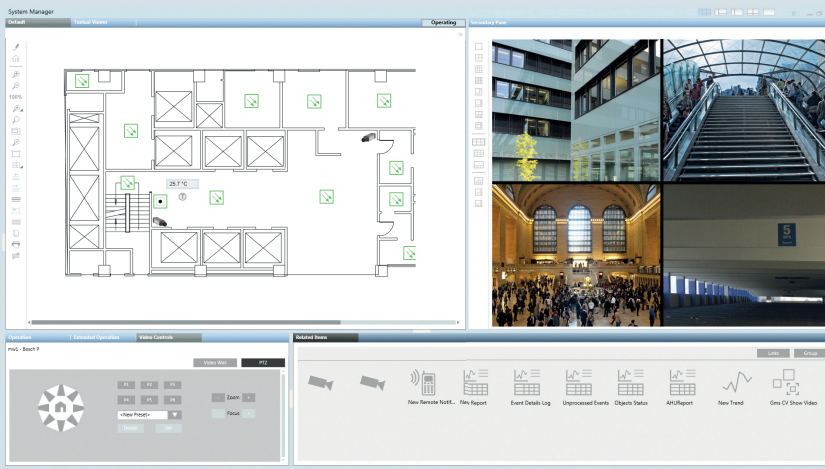

Desigo CC management platform

Desigo CC, the new management platform from Siemens, allows you to monitor and operate multiple disciplines in modern building systems efficiently and according to workflow.

The new Desigo CC building management platform is not only well-suited to control individual systems, it also allows you to integrate and intelligently link all building disciplines from heating, ventilation and air conditioning to lighting and shading, power, fire safety and security. Desigo CC is a flexible management platform based on proven technologies with extensive support for communications standards such as BACnet, OPC, SNMP, SMTP, Modbus and ONVIF. In addition, the management platform is certified under the BACnet B-AWS

profile. The adaptive architecture and operation guarantee a high degree of scalability and maximum investment protection.

The process-oriented operating concept supports fast, intuitive and standardized control of systems as well as the ability to handle management tasks from different areas. A consistent navigation minimizes training and permits flexible modifications in the event that changes are made to the building.



The user interface can be customized to personal preferences. The most important information is displayed first. Windows do not overlap, and all disciplines appear in the same window. Users benefit from an easy-to-understand visualization of all disciplines, and they save time since there is no need to switch applications.

Design CC uses vector graphics for an attractive, high-resolution display of system elements, including full zoom functions. System graphics can be displayed in either 2D or 3D.

Highlights

- All disciplines are integrated into a single management platform
- Process-oriented operating concept optimizes system operation
- Can be flexibly adapted to the customer's needs and growing requirements



Synco 700 – communicating HVAC control

Synco 700 supports the entire life cycle of small to medium-size buildings. The controllers can be extended and adapted at any time, thanks to their modular design and backward compatible communication. This way, investments can also be made in steps.

Being the heart of the building automation and control system, Synco™ 700 is responsible for the generation of heat and refrigeration, controls and monitors plants, and communicates via KNX. Installation and commissioning are fast and efficient, thanks to integrated and proven standard applications, and there is no need for programming. Naturally, individual configurations can also be made easily, if required. The system can be extended at any time since extension modules can be attached to the controllers simply by clicking. With Synco, you save time and costs when it comes to planning, engineering and commissioning.

The preprogrammed energy saving functions ensure energy-optimized operation. Also, the Synco controllers exchange energy-related information via KNX, so that aggregates such as heating boilers, chillers or pumps are switched on only if required to maintain the desired comfort level. This way, Synco provides the preconditions to attain efficiency class A.



Monitored energy efficiency

Room users and facility managers can considerably influence energy consumption by switching the plant off during non-occupancy times or by matching the room temperature and the time schedule to the current occupancy times.

The communicating room controllers RXB and RXL as well as the communicating room thermostats RDG and RDF enable the users to straightforwardly adjust the comfort temperature in the individual rooms. This saves additional energy.

Furthermore, the Synco system supports the user with intelligent functions, such as the energy indicator, which monitors end-user settings, shows non-adherence to limit values and forwards them periodically to the users via e-mail or app.

Whatever the settings, an energy indicator shows the room's energy efficiency state: Green means that the settings made are correct from the point of view of energy usage, orange indicates unfavorable settings. This way, deviations are always visible.

Monitoring and operating building systems via remote access is not only easy, but also secure and efficient. Access via the Synco IC Web portal allows authorized employees to check the status of multiple buildings simultaneously and, if needed, intervene in any system at any time and from anywhere.

For more detailed information, please visit www.siemens.com/synco

Highlights

- Efficient installation thanks to extremely versatile, modular range of HVAC controllers
- Energy efficiency thanks to energy saving functions and exchange of energy-related data
- Enhanced comfort due to individual room climate
- Higher energy efficiency thanks to memory function and reporting of unfavorable conditions from the point of view of energy usage

Planning Tools from Siemens

Energy Performance Classification Tool

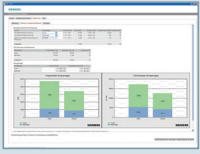

Energy Efficiency Calculation Tool

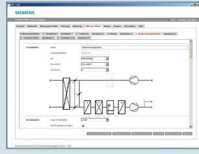

HVAC Integrated Tool

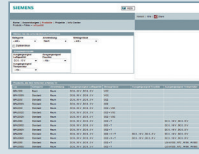

Specification Text Selection Tool

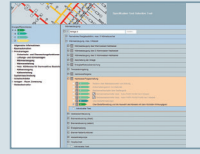

Preliminary study

Project planning

Bidding phase

Project implementation

Operation and modernization

eu.bac system certification

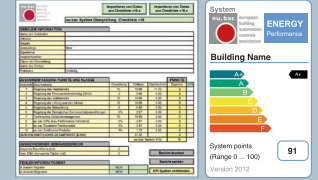

Supporting tools for the sales process

Siemens offers extensive supporting tools for the entire planning and implementation process.

The European Standard EN 15232 distinguishes between four efficiency classes from A to D and defines the energy saving potential for different types of buildings resulting from building automation and control. To check adherence to the classification, the European Building Association (eu.bac) introduced a certification of systems which verifies the functions specified by the standard.

Siemens was the leading company when EN 15232 was developed and is still involved in the standard's maintenance, including certification by eu.bac. Based on this concept, Siemens developed software tools and other means for planning and specifying building automation and control systems. The tools Energy Performance Classification (EPC), Energy Efficiency Calculation (EEC), and the Specification Text Selection Tool (STST) support planning of building automation and control systems during the entire life cycle of a building (new project, extensions, modernization).

Overview of tools:

Preparation of a project

For initial customer contacts and preparatory steps, sophisticated tools and other means, such as brochures, technical documentation, guides and training courses, are available.

EPC – Energy Performance Classification Tool

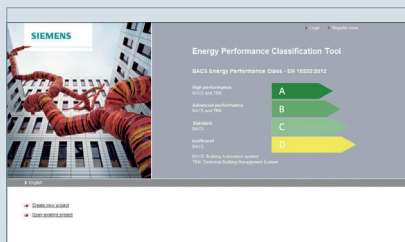

The EPC Tool allows for a quick analysis of the existing building automation and control functions to assess the energy saving potential and the resulting payback time. The calculations are based on the building automation and control efficiency classes according to EN 15232:2012.

EEC – Energy Efficiency Calculation

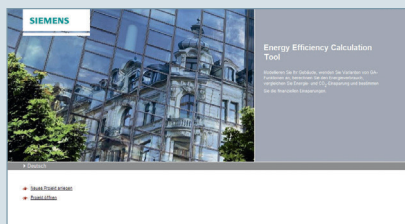

The EEC Tool offers an in-depth analysis of the building automation and control functions and a reliable assessment of energy savings and the payback time. The calculation is made dynamically based on customer-specific buildings. The impact of control functions is also calculated.

STST – Specification Text Selection Tool



STST saves time when preparing functional bids. The comprehensive text database contains product-independent texts to completely describe an entire building automation system. The tool also comes with texts that describe the system requirements on the management, automation, room and field level. In addition, it supports individual descriptions of all applications for primary systems, room functions and control panels.

Tendering phase

The tools used for the classical tendering phase are the HVAC Integrated Tool (HIT) and the Design Configuration Module (DCM). HIT facilitates the simple selection of field devices while, among other things, DCM allows for the creation of extensive parts lists, which can also be used in the ensuing engineering process.



The Siemens Solution Partner program

The Siemens Solution Partner program offers partners added value for all phases of a project.







When talking to decision makers, considerable effort is required to persuade them of the values of your company. Siemens supports you when creating new business relations and when making efforts to stay at the top. Siemens cultivates long-term relationships with strong partners throughout the world. Working with Siemens offers you many competitive advantages and extensive support when dealing with specific customer requirements. Success-related documentation and tools are available via the Solution Partner extranet, 24 hours a day.

The Siemens Solution Partner program is based on five main pillars:

- Products and systems
- Training
- Sales support
- Marketing support
- Technical support

For more information,
as well as our tools, please visit
www.siemens.com/bt/solution-partner

Overview of benefits:

Solution Partner Building Technologies 		Acquisition	Design	Implementation	Services
	Products and systems The comprehensive portfolio of products and systems, together with powerful programming tools, libraries and modules, enables you to develop convincing solutions for your customers.	■	■	■	■
	Training Siemens offers a large number of training courses including the accompanying material.	■	■	■	
	Sales support A number of calculation tools and extensive documentation for a successful sales process are made available via the extranet. These support you when submitting offers or when there is a need to interpret data.	■	■	■	
	Marketing support Solution Partners are identified by a special partner logo. Regional marketing support and a number of marketing tools are available.	■	■		
	Technical support In addition to an extensive choice of supporting documentation, Siemens experts are available to support you should you encounter a technical problem.		■	■	■

Type Overview

Product Number	Description	Datasheet	Page
7411100280	Terminal covers		5-44
ACS790	Commissioning and plant operating software	N5649	5-45
AP 118/01	Control Module Box, 1 slot for a sensor/actuator module, type RS or RL		4-58
AP 221/10	Wall transmitter, EnOcean, titanium white	BMA: Wall Transmitter EnOcean	4-88
AP 221/11	Wall transmitter EnOcean, with I/O-symbols, titanium white		4-88
AP 221/12	Wall transmitter EnOcean, with up/down-symbols, titanium white		4-88
AP 221/30	Wall transmitter EnOcean, aluminum metallic		4-88
AP 221/31	Wall transmitter EnOcean, with I/O-symbols, aluminum metallic		4-88
AP 221/32	Wall transmitter EnOcean, with up/down-symbols, aluminum metallic		4-88
AP 222/10	Wall transmitter EnOcean, titanium white	BMA: Wall Transmitter EnOcean	4-89
AP 222/11	Wall transmitter EnOcean, with I/O-symbols, titanium white		4-89
AP 222/12	Wall transmitter EnOcean, with up/down symbols, titanium white		4-89
AP 222/30	Wall transmitter EnOcean, aluminum metallic		4-89
AP 222/31	Wall transmitter EnOcean, with I/O-symbols, aluminum metallic		4-89
AP 222/32	Wall transmitter EnOcean, with up/down symbols, aluminum metallic		4-89
AP 258E01	Surface-mounting enclosures		4-60
AP 420/13	IR wall switch, single, titanium white		4-46
AP 421/13	IR wall switch, double, titanium white		4-46
AP 422/13	IR wall switch, quadruple, titanium white		4-46
AP 641/01	Room Control Box, 8 slots for a sensor/actuator module, type RS or RL		4-58
AQR2530NNW	Front module for base module, without sensor	N1410	4-35
AQR2531ANW	Front module with passiv temperature measurement, LG-Ni1000	N1408	4-71
AQR2532NNW	Front module for base module, temperature (active)	N1410	4-35
AQR2533NNW	Front module for base module, humidity	N1410	4-35
AQR2535NNW	Front module for base module, humidity and temperature (active)	N1410	4-35
AQR2535NNWQ	Front module for base module, humidity and temperature, with LED	N1410	4-35
AQR2570NF	Base module for temperature and / or humidity measurement, with KNX / PL-Link, 70.8 x 70.8	N1411	4-34
AQR2570NG	Base module for temperature and / or humidity measurement, with KNX / PL-Link, 110 x 64	N1411	4-34
AQR2570NH	Base module for temperature and / or humidity measurement, with KNX / PL-Link, 83 x 83	N1411	4-34
AQR2570NJ	Base module for temperature and / or humidity measurement, with KNX / PL-Link, 64 x 110	N1411	4-34
AQR2576NF	Base module for CO ₂ measurement, with KNX / PL-Link, 70.8 x 70.8 mm	N1411	4-35
AQR2576NG	Base module for CO ₂ measurement, with KNX / PL-Link, 110 x 64 mm	N1411	4-35
AQR2576NH	Base module for CO ₂ measurement, with KNX / PL-Link, 83 x 83 mm	N1411	4-35
AQR2576NJ	Base module for CO ₂ measurement, with KNX / PL-Link, 64 x 110 mm	N1411	4-35
BAU200	Universal digital indicator	N5312	5-40
BSG21.1	Setpoint adjuster, passive, scale 0...50 °C (exchangeable)	N1991	5-21
BSG21.5	Setpoint adjuster, passive, temperature ranges: -20...20 °C; 20...60 °C; -3...3 K	N1991	5-38
BSG61	Active setpoint adjuster 0...100 %, for flush panel mounting	N1992	5-38
DXA.H110	Terminal cover for DXR., 110 mm, 2 pieces		4-31
DXA.H180	Terminal cover for DXR., 180 mm, 2 pieces		4-31
DXR2.E09-101A	Compact room automation station, BACnet/IP, 230 V, flat housing, 1 DI, 2 UI, 3 relay, 3 AO	N9204	4-23
DXR2.E09T-101A	Compact room automation station, BACnet/IP, 230 V, flat housing, 1 DI, 2 UI, 1 relay, 1 AO, 4 triac	N9204	4-24
DXR2.E10-101A	Compact room automation station, BACnet/IP, 230 V, flat housing, 1 DI, 2 UI, 3 relay, 4 triac	N9204	4-25
DXR2.E12P-102A	Compact room automation station, BACnet/IP, 24 V, DIN housing, 1 DI, 2 UI, 2 AO, 6 triac, pressure sensor	N9205	4-26
DXR2.E18-101A	Compact room automation station, BACnet/IP, 24 V, DIN housing, 2 DI, 4 UI, 4 AO, 8 triac, (Fancoil, Radiant ceiling, Radiator, 4 Lights & 2 Shades)	N9205	4-27
DXR2.E18-102A	Compact room automation station, BACnet/IP, 24 V, DIN housing, 2 DI, 4 UI, 4 AO, 8 triac, (Variable air volume, Fan-powered box, Radiant ceiling, Radiator, 4 Lights & 2 Shades)	N9205	4-27

NEW PRODUCT

1

Type Overview

Product Number	Description	Datasheet	Page
DXR2.M09-101A	Compact room automation station, BACnet/MSTP, 230 V, flat housing, 1 DI, 2 UI, 3 relay, 3 AO	N9206	4-28
DXR2.M09T-101A	Compact room automation station, BACnet/MSTP, 230 V, flat housing, 1 DI, 2 UI, 1 relay, 1 AO, 4 triac	N9206	4-28
DXR2.M10-101A	Compact room automation station, BACnet/MSTP, 230 V, flat housing, 1 DI, 2 UI, 3 relay, 4 triac	N9206	4-29
DXR2.M11-101A	Compact room automation station, BACnet/MSTP, 24 V, DIN housing, 1 DI, 2 UI, 2 AO, 6 triac	N9207	4-29
DXR2.M12P-102A	Compact room automation station, BACnet/MSTP, 24 V, DIN housing, 1 DI, 2 UI, 2 AO, 6 triac, pressure sensor	N9207	4-30
DXR2.M18-101A	Compact room automation station, BACnet/MSTP, 24 V, DIN housing, 2 DI, 4 UI, 4 AO, 8 triac, (Fancoil, Radiant ceiling, Radiator, 4 Lights & 2 Shades)	N9207	4-31
DXR2.M18-102A	Compact room automation station, BACnet/MSTP, 24 V, DIN housing, 2 DI, 4 UI, 4 AO, 8 triac, (Variable air volume, Fan-powered box, Radiant ceiling, Radiator, 4 Lights & 2 Shades)	N9207	4-31
FGT-PT1000	Flue gas temperature sensor Pt1000	N1846	5-21
GDB181.1E/KN	VAV compact controller KNX, 24 V, 5 Nm, 150 s, 300 Pa	N3547	4-61
GLB181.1E/3	VAV compact controller, 24 V, 10 Nm, 150 s, 300 Pa, 0...10 V / 3-position	N3544	6-37
GLB181.1E/KN	VAV compact controller KNX, 24 V, 10 Nm, 150 s, 300 Pa	N3547	4-61
N 120/02	Choke, 640 mA	2.14.2.2	6-42
N 125/02	Power supply unit DC 29 V, 160 mA with additional unchoked output, N 125/02	2.14.4.4	4-62
N 125/12	Power supply unit DC 29 V, 320 mA with additional unchoked output, N 125/12	2.14.4.4	4-62
N 125/22	Power supply unit DC 29 V, 640 mA with additional unchoked output, N 125/22	2.14.4.4	4-62
N 140/03	Line/backbone coupler for data rail	2.11.1.12	6-41
N 140/13	Line/backbone coupler	2.14.3.3	6-41
N 146/02	IP router	2.11.1.13	6-39
N 148/11	USB interface	2.11.1.12	6-40
N 148/22	IP interface	2.11.1.14	6-39
OCI700.1	Service tool for KNX / LPB	N5655	5-46
OCI702	Service interface for USB / KNX	A6V10438951	4-62
OZW771.04	Central communication unit, max. 4 controllers	N3117	5-44
OZW771.10	Central communication unit, max. 10 controllers	N3117	5-44
OZW771.64	Central communication unit, max. 64 controllers	N3117	5-44
OZW772.01	Web server for 1 Synco device	N5701	5-43
OZW772.04	Web server for 4 Synco devices	N5701	5-43
OZW772.16	Web server for 16 Synco devices	N5701	5-43
OZW772.250	Web server for 250 Synco devices	N5701	5-43
PMX50	15.6-inch touch panel	N9293	3-19
PX KNX	PX KNX system controller		3-14
PX M-Bus	PX M-bus system controller		3-14
PX Modbus	PX Modbus system controller		3-15
PXA-C1	Connecting cable RJ45 - RJ45, cable length 3 m	N9234	3-17
PXA-C2	Adapter RJ45 - RS232 at computer	N9234	3-17
PXA-C4	Adapter from PXM20.. for firmware download	N9234	3-20
PXA-H1	Multifunction cover blade for panel door or wall mount		3-20
PXA40-RS1	Option module for integration up to 800 data points (SCL, M-bus, Modbus)	N9223	3-16
PXA40-RS2	Option module for integration up to 1000 (SCL) or 2000 (M-bus, Modbus) data points	N9223	3-16
PXA40-T	Option module with remote management via modem for automation stations	N9222	3-10
PXA40-W0	Option module with Web function (generic/graphic) for one automation station	N9222	3-11
PXA40-W1	Option module with Web function (generic) for all automation stations in the BACnet network	N9222	3-11
PXA40-W2	Option module with Web function (generic/graphic) for all automation stations in the BACnet network	N9222	3-11
PXC-NRUD	Adapter plug-in circuit board for Integral NK modules, integrates 48 data points in Desigo	N9761	3-18
PXC-NRUF	Automation station for Integral migration, integrates 64 data points in Desigo	N9760	3-18
PXC00-E.D	System controller BACnet/IP	N9222	3-12

NEW PRODUCT

Type Overview

Product Number	Description	Datasheet	Page
PXC00.D	System controller BACnet/LonTalk	N9222	3-12
PXC001-E.D	System controller for the integration of KNX, M-Bus, Modbus or SCL over BACnet/IP	N9223	3-12
PXC001.D	System controller for the integration of KNX, M-Bus, Modbus or SCL over BACnet/LonTalk	N9223	3-12
PXC100-E.D	Automation station BACnet/IP, with up to 200 data points	N9222	3-10
PXC100.D	Automation station BACnet/LonTalk, with up to 200 data points	N9222	3-10
PXC12-E.D	Automation station with 12 data points and BACnet on IP	N9215	3-7
PXC12.D	Automation station with 12 data points and BACnet on LonTalk	N9215	3-7
PXC200-E.D	Automation station BACnet/IP, with more than 200 data points	N9222	3-10
PXC200.D	Automation station BACnet/LonTalk, with more than 200 data points	N9222	3-10
PXC22-E.D	Automation station with 22 data points and BACnet on IP	N9215	3-8
PXC22.D	Automation station with 22 data points and BACnet on LonTalk	N9215	3-8
PXC3.E16A-100A	Room automation station BACnet / IP and DALI	N9203	4-33
PXC3.E72	Room automation station BACnet / IP, for up to 4 rooms / 8 room segments	N9203	4-32
PXC3.E72-100A	Room automation station BACnet / IP, for up to 4 rooms / 8 room segments	N9203	4-33
PXC3.E72A	Room automation station BACnet / IP and DALI, for up to 4 rooms / 8 room segments	N9203	4-32
PXC3.E72A-100A	Room automation station BACnet / IP and DALI, for up to 4 rooms / 8 room segments	N9203	4-33
PXC3.E75	Room automation station BACnet / IP, for up to 8 rooms / 16 room segments	N9203	4-32
PXC3.E75-100A	Room automation station BACnet / IP, for up to 8 rooms / 16 room segments	N9203	4-33
PXC3.E75A	Room automation station BACnet / IP and DALI, for up to 8 rooms / 16 room segments	N9203	4-32
PXC3.E75A-100A	Room automation station BACnet / IP and DALI, for up to 8 rooms / 16 room segments	N9203	4-33
PXC36-E.D	Automation station with 36 data points and BACnet on IP	N9215	3-9
PXC36.D	Automation station with 36 data points and BACnet on LonTalk	N9215	3-8
PXC50-E.D	Automation station BACnet/IP, with up to 52 data points	N9222	3-10
PXC50.D	Automation station BACnet/LonTalk, with up to 52 data points	N9222	3-10
PXG3.L	BACnet router, BACnet Ethernet/IP to BACnet/LonTalk or BACnet/MS/TP	N9270	3-17
PXG3.M	BACnet router, BACnet Ethernet/IP to BACnet/MS/TP	N9270	3-17
PXG3.W100	Web interface BACnet/IP for Desigo Touchpanels	N9294	3-21
PXM10	Operator unit, local	N9230	3-23
PXM20	Operator unit with BACnet on LonTalk	N9231	3-22
PXM20-E	Operator unit with BACnet on IP	N9234	3-22
PXM40	10.1-inch touch panel	N9292	3-20
PXX-L11	Extension module for up to 60 LonWorks devices / RXC room controllers	N9282	3-11
PXX-L12	Extension module for up to 120 LonWorks devices / RXC room controllers	N9282	3-11
PXX-PBUS	Extension module for Integration of existing PTM I/O modules	N9283	3-11
QAA24	Room temperature sensor LG-Ni1000	N1721	4-71
QAA25	Room unit with room temperature sensor and setpoint adjuster	N1721	5-40
QAA27	Room unit with room temperature sensor and setpoint readjuster -3...3 K	N1721	5-21
QAA64	Room temperature sensor LG-Ni1000 for mounting on recessed conduit boxes	N1722	4-71
QAC22	Outside sensor LG-Ni1000	N1811	5-21
QAC3161	Outside / room temperature sensor DC 0...10V	N1814	5-37
QAC32	Outside sensor NTC 575 Ohm	N1811	5-21
QAD22	Strap-on temperature sensor LG-Ni1000	N1801	5-21
QAD26.220	Strap-on temperature sensor with cable LG-Ni1000	N1802	5-21
QAE2120.010	Immersion temperature sensor 100 mm LG-Ni1000, with protection pocket	N1781	5-21
QAE2120.015	Immersion temperature sensor 150 mm, LG-Ni1000, with protection pocket	N1781	5-37
QAE2121.010	Immersion temperature sensor 100 mm, LG-Ni1000, without protection pocket	N1781	5-37
QAE2121.015	Immersion temperature sensor 150 mm LG-Ni1000, without protection pocket	N1781	5-37
QAE2164.010	Immersion temperature sensor 100 mm DC 0...10 V	N1782	5-37
QAE2164.015	Immersion temperature sensor 150 mm DC 0...10 V	N1782	5-37
QAF63.2-J	Frost detector, modulating, capillary tube 2000 mm	A6V10432020	5-37
QAF63.6-J	Frost detector, modulating, capillary tube 6000 mm	A6V10432020	5-37
QAF64.2-J	Frost detector, modulating and 2-point, capillary tube 2000 mm	A6V10432022	5-37
QAF64.6-J	Frost detector, modulating and 2-point, capillary tube 6000 mm	A6V10432022	5-37
QAM2112.040	Duct temperature sensor 400 mm, Pt1000	N1761	5-37
QAM2120.040	Duct temperature sensor 400 mm, LG-Ni1000	N1761	4-71
QAM2120.200	Duct temperature sensor 2000 mm, LG-Ni1000	N1761	5-37

NEW PRODUCT

3

Type Overview

Product Number	Description	Datasheet	Page
QAM2120.600	Duct temperature sensor 6000 mm, LG-Ni1000	N1761	5-37
QAP21.2	Cable temperature sensor for high-temperature applications (180°C)	N1833	5-37
QAP21.3	Cable temperature sensor silicone 1.5 m, LG-Ni1000	N1831	5-37
QAP22	Cable temperature sensor PVC 2 m, LG-Ni1000	N1831	4-71
QAT22	Window pane temperature sensor	N1830	5-37
QAW740	Room unit with KNX bus	N1633	6-31
QAX30.1	Room unit with sensor and PPS2 interface	N1741	4-83
QAX31.1	Room unit with sensor, setpoint adjuster and PPS2 interface	N1741	4-83
QAX32.1	Room unit with sensor, setpoint and operating mode selector and PPS2 interface	N1641	4-83
QAX33.1	Room unit with sensor, setpoint and operating mode selector, fan speed selection, and PPS2 interface	N1642	4-84
QAX34.1	Room unit with sensor, setpoint and operating mode selector, display and PPS2 interface	N1645	4-84
QAX34.3	Room unit with sensor, setpoint and operating mode selector, display and PPS2 interface	N1640	4-84
QAX39.1	Universal setpoint adjuster with PPS2 interface	N1646	4-84
QAX50.5/C000	Versatile room unit with LonWorks interface, lighting systems (on / off)	N1648	4-91
QAX51.5/C000	Versatile room unit with LonWorks interface, lighting systems (dimmed)	N1648	4-91
QAX84.1/PPS2	Flush-mounted room unit complete with PPS2 interface and design frame	N1649	4-85
QAX95.4	Room unit with EnOcean interface	N1663	4-86
QAX96.4	Room unit with EnOcean interface, setpoint adjuster	N1663	4-86
QAX97.4	Room unit with EnOcean interface, setpoint adjuster, button and switch	N1663	4-87
QAX98.4	Room unit with EnOcean interface, setpoint adjuster, button and switch for fan stages	N1663	4-87
QBE64-DP4	Differential pressure sensor for liquids and gases (DC 0...10 V) 0...400 kPa	N1921	5-37
QFA1000	Room hygrostat, setpoint setting range 30...90 % r.h., setpoint adjuster inside device	N1518	5-39
QFA1001	Room hygrostat, setpoint setting range 30...90 % r.h., external setpoint adjustment	N1518	5-39
QFA2000	Room sensor for humidity (DC 0...10 V)	N1857	5-40
QFA2020	Room sensor for humidity (DC 0...10 V) and temperature (LG-Ni1000)	N1857	5-40
QFA2060	Room sensor for humidity (DC 0...10 V) and temperature (DC 0...10 V)	N1857	5-40
QFA3100	Room sensor for humidity (DC 0...10 V) for demanding requirements	N1858	5-40
QFA3160	Room sensor for humidity (DC 0...10 V) and temperature (DC 0...10 V) for demanding requirements	N1858	5-40
QFA4160	Room sensor for humidity (DC 0...10V) and temperature (DC 0...10V) with calibration certificate	N1859	5-40
QFM2100	Duct sensor for humidity (DC 0...10 V)	N1864	5-38
QFM2120	Duct sensor for humidity (0...10 V) and temperature (Ni1000)	N1864	5-38
QFM2160	Duct sensor for humidity (DC 0...10 V) and temperature (DC 0...10 V)	N1864	5-38
QFM3100	Duct sensor for humidity (DC 0...10 V) for demanding requirements	N1882	5-38
QFM3160	Duct sensor for humidity (DC 0...10 V) and temperature (DC 0...10 V) for demanding requirements	N1882	5-38
QFM4160	Duct sensor for humidity (0...10 V) and temperature (0...10 V) with calibration certificate	N1883	5-38
QFM81.2	Duct hygrostat, setpoint setting range 15...95 % r.h.	N1514	5-39
QFM81.21	Room hygrostat, setpoint setting range 15...95 % r.h., setpoint adjuster inside device	N1514	5-39
QLS60	Solar sensor	N1943	5-21
QMX3.P02	Room operator unit KNX with temperature sensor, configurable touchkeys, LED display	N1602	4-37
QMX3.P30	Room sensor KNX for temperature	N1602	4-36
QMX3.P34	Room operator unit KNX with temperature sensor, segmented backlit display, touchkeys	N1602	4-37
QMX3.P36F	Room unit for KNX PL-Link, freely configurable, flush-mounted with square bezel	N1601	4-34
QMX3.P36G	Room unit for KNX PL-Link, freely configurable, flush-mounted with landscape bezel (3 modules landscape)	N1601	4-34
QMX3.P37	Room operator unit KNX with temperature sensor, segmented backlit display, configurable touchkeys, LED display	N1602	4-38
QMX3.P70	Room sensor KNX for temperature, humidity, CO2	N1602	4-36
QMX3.P74	Room operator unit KNX with sensors for temperature, humidity, CO2, segmented backlit display, touchkeys	N1602	4-37
QMX7.E38	Touch room operator unit 4.3 inch	N9295	4-39

NEW PRODUCT

Type Overview

Product Number	Description	Datasheet	Page
QPA84	Indoor air quality controller with integrated VOC sensor for mixed gas	N1571	5-40
QVE1900	Flow switch for use in hydraulic systems, PN10, DN32...200	N1592	5-21
QVE1901	Flow switch for use in hydraulic systems, PN25, DN20...200	N1594	5-39
QVM62.1	Duct sensor for air velocity	N1932	5-38
QXA2601	Condensation monitor, AC/DC 24 V	N3302	4-71
QXA2602	Condensation monitor, AC/DC 24 V, with remote sensor head (cable length 1.5 m)	N3302	4-71
QXA2603	Condensation monitor, AC 230 V	N3302	4-71
QXA2604	Condensation monitor, AC 230 V, with remote sensor head (cable length 1.5 m)	N3302	4-71
RDD810KN/NF	Touch screen room thermostat with KNX communications, for heating application (for China frames)	N3175	6-24
RDF301	Flush-mount room thermostat with KNX communications, 2-/4-pipe fan coils or DX type equipment	N3171	6-21
RDF301.50	Flush-mount room thermostat with KNX communications, 2-/4-pipe fan coils or DX type equipment, four buttons for switching lights and blinds	N3171	4-66
RDF301.50H	Hotel Flush-mount room thermostat with KNX, 2-/4-pipe fan coils or DX type equipment, four buttons hotel functions	N3171	4-66
RDF600KN	Flush-mount room thermostat with KNX communications, 2-/4-pipe fan coils or DX type equipment	N3171	4-66
RDF800KN	Touch screen room thermostat with KNX communications, for 2-/4- pipe fan coil, universal applications or compressors in DX-type equipment	N3174	4-65
RDF800KN/NF	Touch screen room thermostat with KNX communications, for 2-/4- pipe fan coil, universal applications or compressors in DX-type equipment (for China frames)	N3174	6-20
RDG100KN	Room thermostat with KNX communications, AC 230 V, for fan coil units and universal applications	N3191	4-63
RDG160KN	Room thermostat with KNX communications, AC 24 V, for fan coil units and universal applications, heat pump, fan (1-/ 3-speed, DC), valves (2-point, DC)	N3191	4-64
RDG400KN	Room thermostat with KNX communications, AC 24 V, VAV heating and cooling systems	N3192	4-67
RDU341	Semi Flush-mount room thermostat for rectangular conduit box with KNX communications, for VAV application	N3172	4-68
RL 260/23	Binary Input, 4 inputs for AC/DC 12...230 V		4-54
RL 512/23	Switching actuator, 1 x AC 230 V, C load		4-55
RL 513/23	Binary output (relay), 3 x AC 230 V, 6 A		4-57
RL 521/23	Shutter Actuator, 2 x AC 230 V, 6 A		4-55
RMB795B-1	Central control unit RMB795B-1 with languages de, fr, it, es, pt	N3122	6-26
RMB795B-2	Central control unit RMB795B-2 with languages de, fr, nl, en	N3122	6-26
RMB795B-3	Central control unit RMB795B-3 with languages da, fi, no, sv	N3122	6-26
RMB795B-4	Central control unit RMB795B-4 with languages cs, sk, pl, hu, ru, bg	N3122	6-26
RMB795B-5	Central control unit RMB795B-5 with languages ro, sl, sr, hr, el, tr	N3122	6-26
RMB795B-6	Central control unit RMB795B-6 with language zh	N3122	6-26
RMH760B-1	Heating controller with languages de, fr, it, es	N3133	5-10
RMH760B-2	Heating controller with languages de, en, fr, nl	N3133	5-10
RMH760B-3	Heating controller with languages da, fi, sv, no	N3133	5-10
RMH760B-4	Heating controller with languages pl, cs, sk, hu, ru, bg	N3133	5-10
RMH760B-5	Heating controller with languages sr, hr, sl, ro, el, tr	N3133	5-10
RMK770-1	Boiler sequence controller with languages de, fr, it, es	N3132	5-13
RMK770-2	Boiler sequence controller with languages de, fr, en, nl	N3132	5-13
RMK770-3	Boiler sequence controller with languages da, fi, sv, no	N3132	5-13
RMK770-4	Boiler sequence controller with languages pl, cs, sk, hu, ru, bg	N3132	5-13
RMK770-5	Boiler sequence controller with languages sr, hr, sl, ro, el, tr	N3132	5-13
RMS705B-1	Switching and monitoring device with languages de, fr, it, es, pt	N3124	5-34
RMS705B-2	Switching and monitoring device with languages de, fr, nl, en	N3124	5-34
RMS705B-3	Switching and monitoring device with languages da, fi, no, sv	N3124	5-34
RMS705B-4	Switching and monitoring device with languages pl, cs, hu, ru, sk, bg	N3124	5-34
RMS705B-5	Switching and monitoring device with languages el, ro, sl, sr, hr, tr	N3124	5-34
RMS705B-6	Switching and monitoring device with language zh	N3124	5-34
RMU710B-1	Universal controller, 1 control loop, with languages de, fr, it, es	N3150	5-23
RMU710B-2	Universal controller, 1 control loop, with languages de, en, fr, nl	N3150	5-23
RMU710B-3	Universal controller, 1 control loop, with languages da, fi, sv, no	N3150	5-23

NEW PRODUCT

5

Type Overview

Product Number	Description	Datasheet	Page
RMU710B-4	Universal controller, 1 control loop, with languages cs, hu, pl, sk, ru, bg	N3150	5-23
RMU710B-5	Universal controller, 1 control loop, with languages sr, hr, sl, ro, el, tr	N3150	5-23
RMU710B-6	Universal controller, 1 control loop, with language zh	N3150	5-23
RMU720B-1	Universal controller, 2 control loops, with languages de, fr, it, es	N3150	5-23
RMU720B-2	Universal controller, 2 control loops, with languages de, en, fr, nl	N3150	5-23
RMU720B-3	Universal controller, 2 control loops, with languages da, fi, sv, no	N3150	5-23
RMU720B-4	Universal controller, 2 control loops, with languages cs, hu, pl, sk, ru, bg	N3150	5-23
RMU720B-5	Universal controller, 2 control loops, with languages sr, hr, sl, ro, el, tr	N3150	5-23
RMU720B-6	Universal controller, 2 control loops, with language zh	N3150	5-23
RMU730B-1	Universal controller, 3 control loops, with languages de, fr, it, es	N3150	5-23
RMU730B-2	Universal controller, 3 control loops, with languages de, en, fr, nl	N3150	5-23
RMU730B-3	Universal controller, 3 control loops, with languages da, fi, sv, no	N3150	5-23
RMU730B-4	Universal controller, 3 control loops, with languages cs, hu, pl, sk, ru, bg	N3150	5-23
RMU730B-5	Universal controller, 3 control loops, with languages sr, hr, sl, ro, el, tr	N3150	5-23
RMU730B-6	Universal controller, 3 control loops, with language zh	N3150	5-23
RMZ780	Module connector	N3138	5-15
RMZ782B	Heating circuit module	N3136	5-11
RMZ783B	DHW module	N3136	5-11
RMZ785	Universal module (8UI)	N3146	5-15
RMZ787	Universal module (4UI, 4DO)	N3146	5-15
RMZ788	Universal module (4UI, 2AO, 2DO)	N3146	5-15
RMZ789	Universal module (6UI, 2AO, 4DO)	N3146	5-15
RMZ790	Plug-in type operator unit	N3111	5-14
RMZ791	Detached operator unit with 3 m cable	N3112	5-14
RMZ792	Bus operator unit	N3113	5-14
RS 510/23	Binary output devices, 2 x 230 V AC, 10 A (resistive load)		4-56
RS 520/23	Shutter Actuator, 1 x 230 V AC, 6 A		4-54
RS 525/23	Universal Dimmer, 1 x 230 V AC, 250 VA, (R,L,C load)		4-58
RXB21.1/FC-10	Room controller for 3-speed fan	N3873	4-69
RXB21.1/FC-11	Room controller for 3-speed fan	N3873	4-69
RXB22.1/FC-12	Room controller with 3-speed fan and electric heating coil	N3873	4-69
RXB24.1/CC-02	Room controller for chilled ceilings and radiators	N3874	4-69
RXB39.1/FC-13	Room controller for fan-coil applications with KNX communication	N3875	4-70
RXC10.5/00010	Radiator, chilled ceilings and VAV room controller with LonWorks communication and basic application 00010	N3830	4-73
RXC20.5/00020	Room controller for fan coils with 1-speed fan or chilled ceiling/radiator with basic application 00020	N3834	4-74
RXC21.5/00021	Room controller for fan coils with 3-speed fan and/or outside air damper with basic application 00021	N3834	4-74
RXC22.5/00022	Room controller for fan coils with 3-speed fan and electric reheater with basic application 00022	N3834	4-74
RXC30.5/00030	Radiators, chilled ceilings, lighting, base module with LonWorks communication, basic application 00030	N3840	4-76
RXC31.5/00031	VAV base module with LonWorks communication, basic application 00031	N3844	4-77
RXC32.5/00032	VAV room controller with LonWorks communication, basic application 00032	N3845	4-78
RXC39.5/00039	Communicating room controller, with LonMark compatible bus communication	N3856	4-75
RXC40.5	Extension module for lighting control	N3842	4-79
RXC41.5	Extension module for blinds control	N3843	4-79
RXL21.1/FC-10	Room controller for 3-speed fan	N3877	6-9
RXL21.1/FC-11	Room controller for 3-speed fan	N3877	6-9
RXL22.1/FC-12	Room controller with 3-speed fan and electric heating coil	N3877	6-9
RXL24.1/CC-02	Room controller for chilled ceilings and radiators	N3878	6-9
RXL39.1/FC-13	Communicating room controller for fan-coil applications with proprietary communication	N3876	6-10
RXM21.1	I/O block with KNX PL-Link block for use with a PXC3.E7.. series room automation station	N3835	4-52
RXM39.1	I/O block with KNX PL-Link for use with a PXC3.E7.. series room automation station	N3836	4-53
RXT20.1	Service unit with LCD	N3851	4-92

NEW PRODUCT

Type Overview

Product Number	Description	Datasheet	Page
RXZ01.1	Bus terminator 52.3 Ohm for LonWorks bus	N3861	3-17
RXZ02.1	Bus terminator 105 Ohm for LonWorks bus	N3861	3-17
RXZ20.1	Terminal cover for RXB../ RXL2../ RXC2../ RXM2..	N3834	4-53
RXZ30.1	Terminal cover for RXB3.. / RXL3.. / RXC3../ RXM3..	N3840	4-53
RXZ40.1	Terminal cover for RXC4.. and AQX2000	N3842	4-79
RXZ95.1/LON	Radio frequency receiver with Gateway EnOcean/LonWorks, AC / DC 24 V, external antenna	N1661	4-90
RXZ97.1/KNX	Radio frequency receiver with Gateway EnOcean/KNX	N1662	4-90
RYT182	Changeover thermostat, changeover, 30 °C / 19 °C, IP54	N1295	5-39
S 255/11	IR remote control accessories		4-60
S 425/72	IR remote, silver		4-45
SEA45.1	Current valve	N4937	5-40
SEM61.4	Signal converter DC 0...10 V or DC 0 / 10 V in AC 0 / 24 V	N5102	5-40
SEM62.1	Transformer	N5536	6-38
SEM62.2	Transformer with switch and replaceable fuse	N5536	6-38
SEZ220	Signal converter with preprogrammed applications	N5146	5-40
SSA81	Electromotoric actuator, 100 N, 2.5/5 mm, 1.5 m, AC 24 V, 3P	N4893	4-72
SSB81	Electromotoric actuator, 200 N, 5.5 mm, AC 24 V, 1.5 m, 3P	N4891	4-72
SSP81	Electromotoric actuator, 160 N, 2.5 mm, 1.5 m, AC 24 V, 3P	N4864	4-72
STA73PR/00	Electrothermal actuator, AC/DC 24 V, NC, 2P, PDM, PR	N4884	4-72
STP73PR/00	Electrothermal actuator, AC/DC 24 V, NO, 2P, PDM, PR	N4884	4-72
TXA1.5K120	Address key 5, 10 ... 120 + 2 reset keys	N8170	3-31
TXA1.IBE	Island bus expansion module for decentralized sub-islands with TX-I/O-modules	N8184	3-30
TXA1.K-120	Address keys 97-120 + 2 reset keys	N8170	3-31
TXA1.K-48	Address keys 25-48 + 2 reset keys	N8170	3-31
TXA1.K-72	Address keys 49-72 + 2 reset keys	N8170	3-31
TXA1.K-96	Address keys 73-96 + 2 reset keys	N8170	3-31
TXA1.K12	Address Keys 1-12 + reset key	N8170	3-31
TXA1.K24	Address Keys 1-24 + 2 reset keys	N8170	3-31
TXA1.LA4	Labels (sheet A4 with 9 labels)	N8170	3-31
TXA1.LH	Spare transparent label holders (10 pcs.)	N8170	3-31
TXB1.PBUS	P-bus interface module	N8180	3-31
TXI1.OPEN	TX Open RS232/485 module for integrating third-party systems and devices to Desigo	N8185	3-29
TXM1.16D	16 Digital Input Module	N8172	3-24
TXM1.6R	6 Relay output module	N8175	3-25
TXM1.6R-M	6 Relay output module with Override	N8175	3-26
TXM1.6RL	6 Relay output module, bistable	N8177	3-25
TXM1.8D	8 Digital Input Module	N8172	3-24
TXM1.8P	8 Resistance measuring input module	N8176	3-26
TXM1.8RB	8 Relay output module for blinds control	N8178	4-48
TXM1.8T	8 Triac output module	N8179	3-27
TXM1.8U	8 Universal I/O Module	N8173	3-27
TXM1.8U-ML	8 Universal I/O Module, Override and LCD	N8173	3-27
TXM1.8X	8 Universal I/O Module, 4-20mA,	N8174	3-28
TXM1.8X-ML	8 Universal I/O Module, 4-20mA, Override and LCD	N8174	3-28
TXS1.12F10	TX-I/O Power Supply Modules 24 VDC Supply 1200 mA, 10 A Fuse	N8183	3-30
TXS1.EF10	BUS Connection Module, 10A Fuse	N8183	3-30
UA1T	Power amplifier for thermal actuators AC 24 V, PWM	N3591	4-70
UP 117/12	Bus transceiver modules, Mounting depth 18 mm		4-45
UP 220D31	Pushbutton interface, 4 x potential-free contact, output for LED control		4-40
UP 221/12	Pushbutton, single, without status LED, titanium white		4-41
UP 221/13	Pushbutton, single, with status LED, titanium white		4-41
UP 221/32	Pushbutton, single, without status LED, aluminum metallic		4-41
UP 221/33	Pushbutton, single, with status LED, aluminum metallic		4-41
UP 222/12	Pushbutton, double, without status LED, titanium white		4-41
UP 222/13	Pushbutton, double, with status LED, titanium white		4-41
UP 222/32	Pushbutton, double, without status LED, aluminum metallic		4-41

NEW PRODUCT

7

Type Overview

Product Number	Description	Datasheet	Page
UP 222/33	Pushbutton, double, with status LED, aluminum metallic		4-41
UP 223/12	Pushbutton, triple, without status LED, titanium white		4-41
UP 223/13	Pushbutton, triple, with status LED, titanium white		4-41
UP 223/15	Pushbutton, triple, with status LED, with scene controller, with IR receiver decoder, titanium white		4-42
UP 223/32	Pushbutton, triple, without status LED, aluminum metallic		4-41
UP 223/33	Pushbutton, triple, with status LED, aluminum metallic		4-41
UP 223/35	Pushbutton, triple, with status LED, with scene controller, with IR receiver decoder, aluminum metallic		4-42
UP 255D21	Brightness sensor with constant light level controller		4-59
UP 258D11	Presence detector / Motion detector with brightness sensor		4-59
UP 258D12	Presence detector with brightness sensor		4-59
UP 285/12	Pushbutton, single, without status LED, titanium white		4-43
UP 285/13	Pushbutton, single, with status LED, titanium white		4-43
UP 285/42	Pushbutton, single, without status LED, platinum metallic		4-43
UP 285/43	Pushbutton, single, with status LED, platinum metallic		4-43
UP 286/12	Pushbutton, double, without status LED, titanium white		4-43
UP 286/13	Pushbutton, double, with status LED, titanium white		4-43
UP 286/42	Pushbutton, double, without status LED, platinum metallic		4-43
UP 286/43	Pushbutton, double, with status LED, platinum metallic		4-43
UP 287/12	Pushbutton, quadruple, without status LED, titanium white		4-43
UP 287/13	Pushbutton, quadruple, with status LED, titanium white		4-43
UP 287/15	Pushbutton, quadruple, with status LED, with scene controller, with IR receiver decoder, titanium white		4-44
UP 287/42	Pushbutton, quadruple, without status LED, platinum metallic		4-43
UP 287/43	Pushbutton, quadruple, with status LED, platinum metallic		4-43
UP 287/45	Pushbutton, quadruple, with status LED, with scene controller, with IR receiver decoder, platinum metallic		4-44
UP 510/03	Binary Output, 2 x 230 V AC, 10A, 10-pole BTI socket for plugging of bus terminal devices and mounting frame		4-56
UP 510/13	Binary Output, 2 x 230 V AC, 10A, without mounting frame		4-56
UP 520/03	Shutter Actuator with mounting frame and BTI socket		4-54
UP 520/13	Shutter Actuator without mounting frame		4-54
UP 525/03	Universal Dimmer, 1 x 230 V AC, 10 ... 250 VA, with mounting frame and BTI interface		4-57
UP 525/13	Universal Dimmer, 1 x 230 V AC, 10 ... 250 VA, without mounting frame		4-57

NEW PRODUCT

System functions

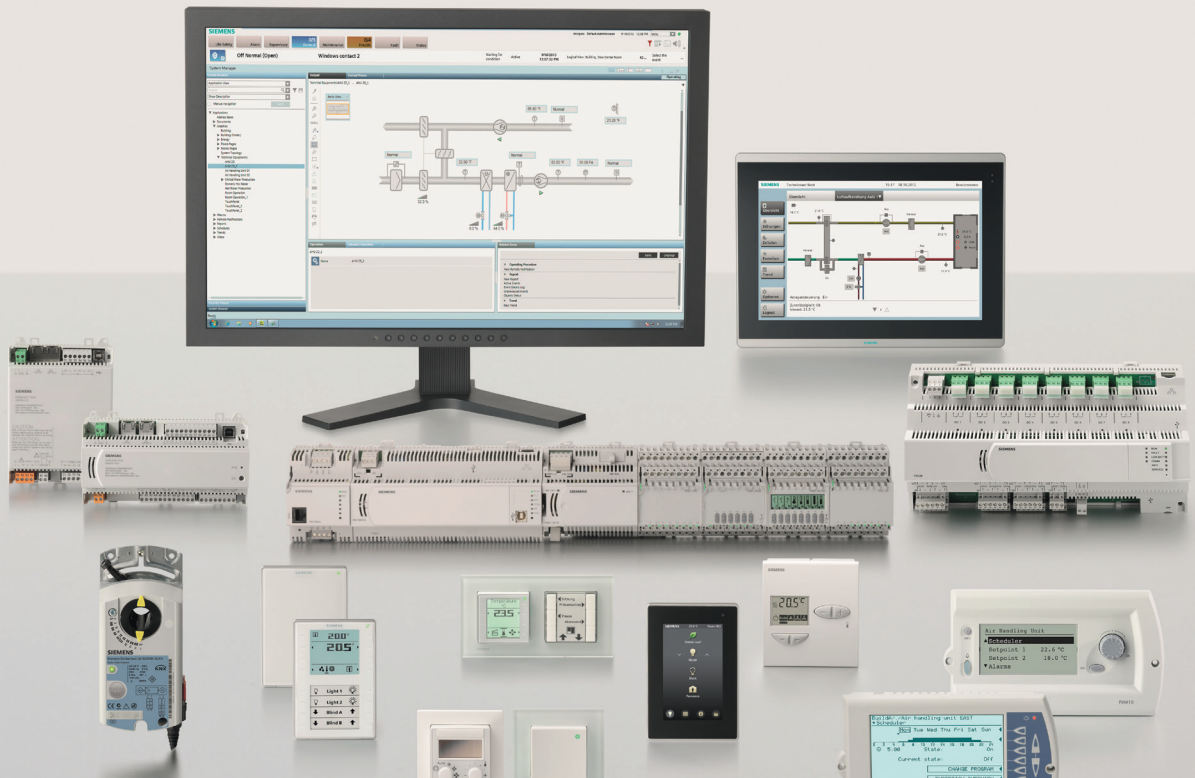

Systemfunktionen	Design – the innovative system for highest efficiency and safety in the building	1-2
	Design system topology	1-3
	System functions for building automation	1-4
	Trend and history function	1-5
	Event management	1-6
	Schedulers/calendar	1-7
	Access rights	1-8
	Monitoring functions	1-9
	Communication – network	1-10

System functions

Desigo – the innovative system for highest efficiency and safety in the building

Desigo™ is a modern building management system for a full breadth of application support ensuring that facilities remain comfortable, productive, and achieve optimal energy and equipment performance. On top Desigo offers full integration of fire safety, and security systems.

With system functions such as event management (events and alarms), time scheduling and trend logging, combined with advanced control functions, Desigo is a highly versatile asset in a building. Innovative Web technology, powerful databases and open communication make Desigo a financially wise investment in the future. It is scalable from small to large buildings and optimized for single as well as multiple disciplines.

Desigo is consistent in its support of open communication, making it easy to connect a wide variety of building services systems on the basis of standard open data interfaces:

- BACnet™ from room automation to the management level
- Modbus, OPC client & server, MS/TP, M-bus and other interfaces for universal connection of third-party devices and systems
- Ethernet TCP/IP network protocol including IP device monitoring via SNMP
- ONVIF standard for network camera (IP video camera) systems

One system for every requirement



As an integration platform, Desigo CC™ is designed for a simultaneous connection to multiple systems and use by multiple operators, each with their unique focus. With Desigo you can be assured of optimal system performance of building automation and fire life safety applications. All building functions – including lighting, power, video, and danger and energy management – can be integrated.

The workflow-oriented user interface of Desigo CC provides the same look, feel and operation to all connected subsystems from small single-user systems to large multi-user installations. This brings integration to the next level, a unification where tasks are not differentiated by the subsystem. Desigo CC unifies workflows and user interfaces for supervisory tasks such as commanding, event handling, reporting, and scheduling.

A unique, extensible object modeling approach allows Desigo CC to normalize information brought in through any interface, and to provide the same look, feel and operation through a common set of applications, without concern for the source of the data.

Investment protection over the building's entire life-cycle

With its flexible range of automation stations and operator units, Desigo is ideally suited for projects of all sizes and for all types of buildings. Consistent compatibility protects investment over decades and throughout the entire building life-cycle. Desigo integrates existing automation systems Visonik, Unigyr, Integral or Simatic seamlessly and carries them forward into the future. Changes in use, system extension and retrofit projects can all be handled in gradual stages.

Existing installations and Desigo components such as the management station Desigo Insight are fully supported and can be supplemented with products and features of the latest generation.

Highest degree of energy efficiency

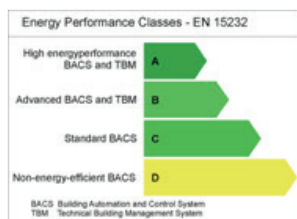

For building automation, the tested Desigo plant applications comply with European standard EN 15232 in the highest energy performance classes. Their use, for example, can reduce energy costs for volume flow control of ventilation plants up to 30% compared to constant air volume control. In addition, a number of Desigo room applications are already eu.bac-certified.



The high level of overall Desigo system functionality is the prerequisite for eu.bac system certification. Also, a number of Desigo room automation products have eu.bac product certification. The combination of both certifications ensures the highest level of energy efficiency in the building.



Desigo offers monitoring functions by means of comprehensive indication of the efficiency status in a building. The Green Leaf symbol indicates unnecessary energy consumption in the building to room users. The room users can ensure interactively the highest possible building efficiency.

The Designo system can be subdivided into two levels:

- Management level
- Automation level

The automation level forms the interface to the field level and includes room automation as well. By virtue of distributed intelligence, each of these levels operates both autonomously and in a network.

The principal Designo system components for building automation

- The Designo management platform allows the monitoring of the entire system from a central location. Designo CC is the perfect tool for superimposed operation and monitoring, graphics-based display of the process, automatic event and alarm distribution providing a wide range of information and reporting capabilities
- Designo PX automation range for control, operation and monitoring of primary plants. Designo Touch and Web can operate the plant via touch panel or Web client
- Designo TX-I/O modules, which provide the interface to the devices at the field level, the sensors and actuators
- Designo Total Room Automation (TRA) is an open and programmable room automation product range covering lighting, shading, and HVAC and allowing for individually tailored room solutions at a high level of energy efficiency
- Compact and proven Designo room automation system RX for autonomous comfort control in individual rooms
- Designo Open for the integration of a wide variety of plants and protocols at all system levels

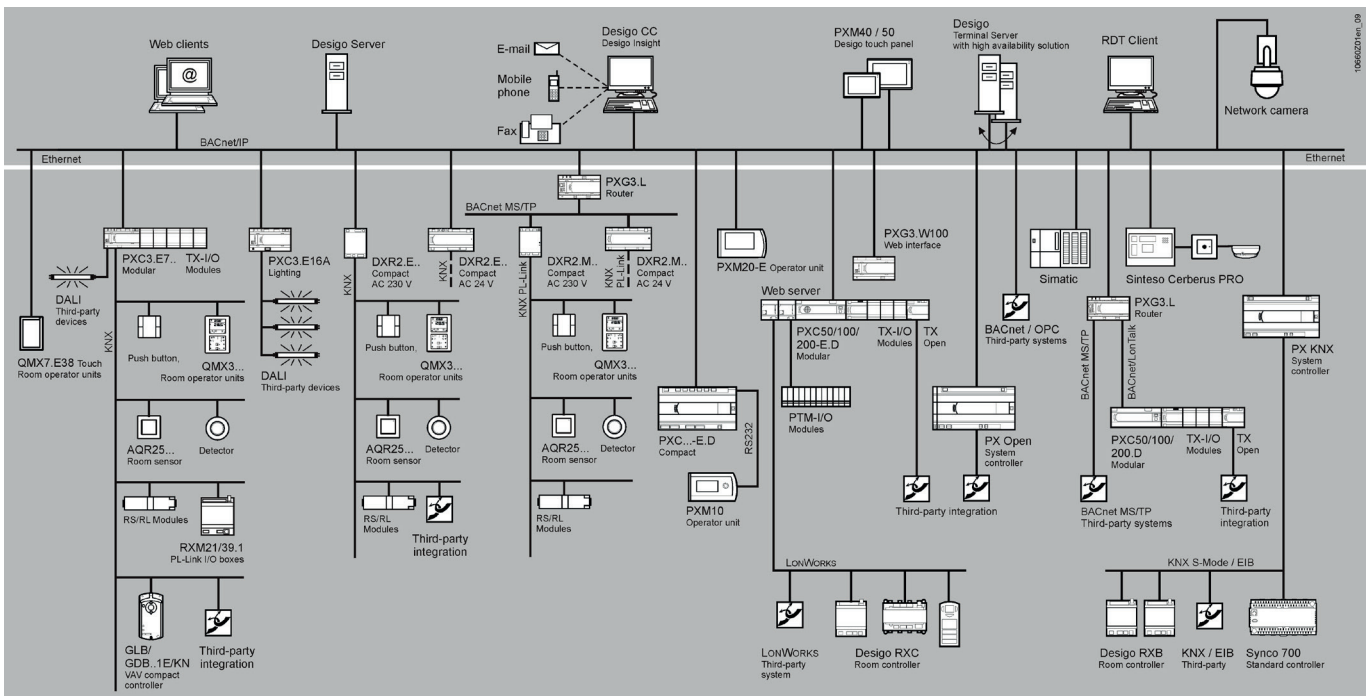

Designo system topology

One of the key benefits of Designo is its scope for gradual extensions, from the smallest systems to large, geographically distributed systems with multiple disciplines.

System functions

System functions for building automation

Facility managers and room users of the Desigo system have a versatile range of tools at their disposal, offering convenient access to the system and the plant.

Operation and monitoring

Operator station

- The Desigo management platform is designed to provide a single, easy-to-use point of access to the entire installation used in your facility. Desigo CC provides multiple client/server options that allow full operation and configuration from anywhere.
- Desigo Touch and Web operate and monitor the Desigo PX automation level using a standard Web browser (HTML5 technology) on various hardware platforms (e.g. tablets, notebooks/PCs, smartphones)

Room operator unit

- The QMX room operator unit with optional Green Leaf symbol offers users functionality precisely matched to need
- QAX.. with or without display and operating element offers functionality matched to the specific needs of the user and the elegant QAX devices support both KNX and LONWORKS communications as well as wireless EnOcean technology

Plant operation

- The Desigo touch panels PXM40 (10 inch) and PXM50 (15 inch) to operate and monitor the Desigo PX automation level with graphical display, optimized to intuitive finger operation
- The user-friendly, graphics-based PXM10 operator unit facilitates full local operation of the Desigo PX automation stations
- The PXM20 network-compatible graphics-based operator unit presents Desigo PX plant and system information in an easy-to-understand format with a clear-text commentary

Manual operation

- The Desigo TX-I/O modules include facilities for manual/emergency operation of plants and for the display of operating states

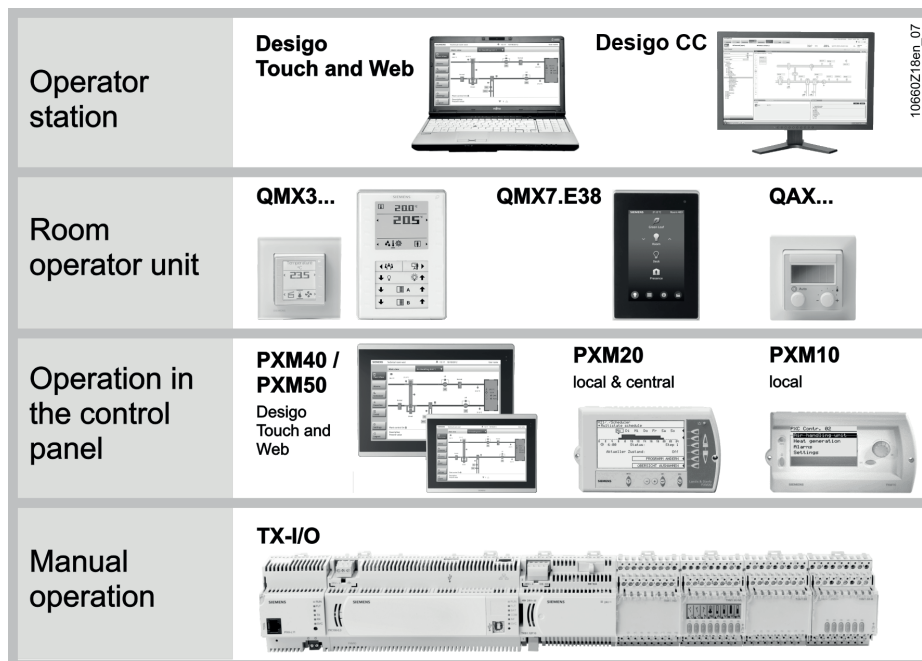

Desigo operating levels

Fully integrated trend data processing allows effortless evaluation and analysis of real-time (online) data and (offline) historical data. The trend feature facilitates the monitoring and fine-tuning of the plant. In the Desigo system, this feature is implemented in the form of Trendlog and TrendlogMultiple objects, in compliance with the BACnet standard.

Trend logging options

- Continuous logging
- Single run
- Logging over a specified period

Sampling options

- Polling
- COV polling (Change of Value)
- Event-driven polling

Trend graphs can be displayed on the Desigo management platform. In addition, the touch panels PXM40/PXM50 and operator units PXM20 as well as PX-Web can display Desigo PX trend graphs. The management platform Desigo CC allows clear trend comparison e.g. to help finding the cause of energy inefficiency.

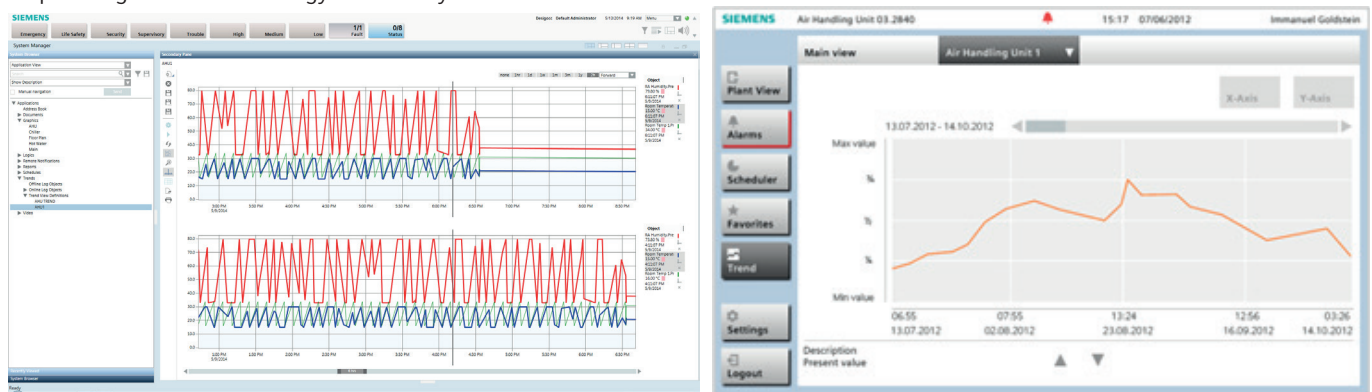

Trend viewer on the management platform Desigo CC and on the touch panels PXM40/PXM50

Online trend features

- Real-time display of process data
- Based on changes in the value of a data point (COVs) or on periodic sampling by Trend Viewer (times can be configured)

Offline trend features

- Offline data display – no permanent connection required
- Longer periods of time (days, months)
- Data acquisition in the automation system
- Data are uploaded to the management level at regular intervals or as needed

System functions

Event management

One of the most important functions of a system is automatic alarming in the event of faults in building services plants. The management of events and alarms (generation, display and handling) must be simple, efficient and consistent at all levels of the system. Desigo uses the BACnet alarm functions and supports the following three types of alarms with up to 256 alarm priority levels:

- Basic alarm (for alarms not requiring user interaction)
- Simple alarms (for alarms requiring acknowledgment)
- Extended alarms (alarms requiring acknowledgement and reset)

Event messages

When an event or alarms occurs, it is automatically detected, registered and transferred to operator units such as the touch panels PXM40/PXM50, the PXM20, or to the management platform. Informative messages are also transmitted to remote devices such as mobile phones, printers, PCs or via SMS and e-mail. The management platform further separates messages in a customized manner so that each user receives only those events and alarms that correspond to his/her level of responsibility.

The event lists of Desigo CC provide a view of all pending and time-stamped events and alarms in order of their importance at a glance and permit guided processing (assisted treatment). Operators are alerted to incoming and pending messages with the event bar and audible and visual signals.

Cover	Message	Counter	Comments	Information	Event Status	Alarm Status	Priority	Category
Device Return	BG FC20 Panel 1	4			Unprocessed	Clear	20120912 20:54:19	Management - Air Handling Units
Low Limit	MEC10_RM100_RMTMP [RM 100 RMT...				Waiting for Condition	Active	20120912 12:21:56	Management - Air Handling Units
Low Limit	MEC10_RM100_EE1_FLOATINGLIMIT				Waiting for Condition	Active	20120912 12:21:56	LogikArea_MEC10_RM100_EE1
Low Limit	My Description2				Waiting for Condition	Active	20120912 12:22:01	LogikArea_Logik_ID
Low Limit	RoomTempAlarm				Waiting for Condition	Active	20120912 12:22:01	LogikArea_Logik_ID
Low Limit	MEC10_RM100_EE2_OUTOFFRANGE				Waiting for Condition	Active	20120912 12:22:01	LogikArea_MEC10_RM100_EE2
Low Limit	MBC05_LAO PT (EE_1_216879)				Waiting for Condition	Active	20120912 2:03:07 PM	Design CC - Field Network - BNCNet Network 1 - Hardware_MBC05_Logik_ID
Trouble IN (Fault)	Power supply superv_6 batt_charger				Ready to be closed	Active	20120912 12:00:00	Design CC - Field Network - BNCNet Network 2 - Hardware_MBC05_Logik_ID
Trouble IN (Fault)	Power supply superv_6 batt_charger				Ready to be closed	Active	20120912 12:00:00	Design CC - Field Network - BNCNet Network 2 - Hardware_MBC05_Logik_ID
Trouble IN (Fault)	NODE 2 MAIN MOTHER BOARD				Ready to be closed	Active	20120912 11:41:15	Management - Air Handling Units - MBT Fire System - Hardware_MBC05_Logik_ID
Trouble IN (Fault)	NODE 1 MAIN MOTHER BOARD				Ready to be closed	Active	20120912 11:41:15	Design CC - Field Network - MBT Fire System - Hardware_MBC05_Logik_ID

Alarms for example on touch panels PXM40/PXM50 and the event list of Desigo CC

Remote Notification with assisted treatment

Messages are transferred on the basis of time of day, priority and/or plant type, using a truly powerful remote notification system at the management platform. This ensures the uninterrupted routing of events and alarms, irrespective of whether or not there is an operator sitting at the management platform. From the event list or event bar, operators can quickly open the assisted treatment in order to perform operating procedures which help ensure a fast and correct response even in critical alarm situations.

One of the basic functions of a system is time control of procedures and processes and ensuring energy-efficient operation.

Scheduler programs ensure that the heating and lighting are switched off automatically at the end of the workday, that the temperature in the building is reduced at night, and that the plant is not kept running for longer than necessary. They can also be used to switch off the air conditioning in certain rooms during holidays.

Using standard BACnet functions, the BACnet scheduler programs can be operated system-wide from the user-friendly touch panels PXM40/PXM50, the operator units PXM20 and PX-Web as well as from the Desigo management platform.

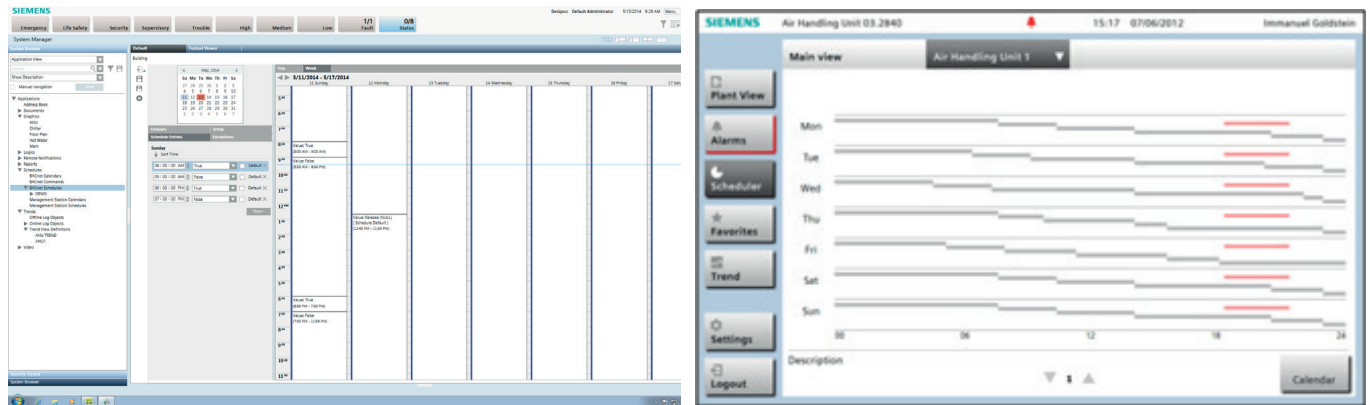

Scheduler program on the management platform Desigo CC and on touch panels PXM40/PXM50

Schedules and calendars are stored in the Desigo PX automation station, so that in the event of a network or PC failure, the automation level can continue to operate autonomously. For connected subsystems that do not support scheduling the management platform performs this function.

Access rights can be used to filter information from the plant and system based on the individual requirements of a user. The caretaker or service engineer, for example, only has access to information important to him. A distinction can also be made between read access and write access.

Freely-definable access rights

Only authorized personnel are granted access to the system via the operator units. When a user enters a user name and password, the system verifies the associated access rights and enables access to the relevant plant. Read and write access rights can be defined in detail, right down to individual information points.

The following access classes are supported in the Desigo system:

- Internal, service and standard service
- Administration and experts
- Standard and customer

Predefined user profiles

To ensure the right level of event management, users can be easily assigned to predefined roles that match their job profiles. This ensures efficient and targeted event management.

Efficient plant overview

For simple and efficient plant overview, the Desigo touch panels PXM40/PXM50 can display the most important plant values on an overview page, even without logging on.

Increasing building efficiency/saving energy

Thanks to sophisticated monitoring functions, Desigo provides comprehensive indication of the efficiency status in the building. The RoomOptiControl function of Desigo TRA automatically detects unnecessary energy consumption in the room. This is indicated to the room user via a change of color of the Green Leaf symbol from green to red on the QMX3 room operator unit. When pressing the symbol, room control resumes energy-optimized operation. Then, the Green Leaf symbol will again return to green.



The Green Leaf symbol on the QMX3 and QMX7.E38 operator units

1 System functions

Communication – network

Communication standards specially developed for building systems

Compliant devices can be interconnected at low cost using the BACnet (Building Automation and Control network) open communication protocol. The worldwide BACnet standard was developed specifically for the needs of building services.

Desigo CC is an open management platform built on a proven SCADA technology and supports a variety of open system protocols and IT standards. Thanks to the support of the BACnet Life Safety objects, simple and secure connection to fire detection systems such as Sinteso FS20 or Cerberus PRO to Desigo is possible without problems.

BACnet, KNX and LonWorks

For the exchange of information among its own system components, Desigo uses for building automation three standard protocols, recognized worldwide: BACnet, KNX (EIB) and LonWorks. Desigo uses the BACnet communication protocol to exchange information between the individual Desigo PX automation stations and the Desigo TRA room automation stations on the one hand, and to the Desigo management platform on the other.

Desigo uses IP, LonTalk or MS/TP as the transport medium.

Furthermore, Desigo supports integration of BACnet/MSTP subsystems. The PXG3 router provides transparent BACnet traffic between the MSTP and IP network (BACnet/IPv4 as well as BACnet/IPv6) and, optionally, to LonTalk as an addition.

The integrated KNX connection on Desigo TRAs room automation station PXC3 and DXR permits direct integration of both devices with the KNX PL-Link as well as KNX S-Mode in Desigo TRA. Communication between room automation stations and field devices with KNX PL-Link is optimized within the framework of the KNX standard for available plug-and-play functionality including automatic device recognition. Desigo Tools parameterize devices with the KNX PL-Link; the KNX commissioning software (ETS) is not required. A broad selection of Siemens field devices, including room operator units, buttons, motion detectors, or VAV compact controllers support the KNX PL-Link.

Also, the Desigo RX room automation product range communicates per LONMARK standard or KNX S-Mode (EIB).

BACnet certification

All Desigo PX and TRA BACnet servers as well as the Desigo management platform were submitted to the BACnet Interest Group Europe (BIG-EU) for compliance testing based on the BACnet standard DIN EN ISO 16484-5 and successfully certified. A well-known testing institution conducted the comprehensive testing.



The management platform, as well as the automation and room automation stations are all implemented as full BACnet nodes. BACnet is integrated directly without the need for any special data conversion.

The Desigo PX automation stations satisfy the B-BC profile (BACnet Building Controller). Desigo CC and Desigo Insight satisfy the B-AWS profile (BACnet advanced workstation). The Desigo TRA room automation stations support a BACnet object's scope (BACnet B-ASC profile) adjusted to room automation.

Web Services

Using RESTful technology, Desigo CC provides alarm, object and time series data via web based services to any 3rd party application.

AMEV guideline

Open communication between various systems using a common automation and operating concept are key functions for energy-saving and reliable plant operation. As a consequence, Desigo meets in full the AMEV guideline V1.2 with the following profiles:

- Desigo management: AMEV profiles MBE-A and MBE-B
- Desigo PX: AMEV profiles AS-A and AS-B

OPC Foundation Certification

The Desigo CC management platform is designed as an open platform and supports various open standard communication protocols and IT standards such as OPC client and server for the OLE process control or ONVIF standard for IP-based video surveillance.

OPC is the interoperability standard for the secure and reliable exchange of data in the automation space and in other industries. Desigo CC has been certified by the OPC Foundation meaning it has been tested and has passed independent OPC testing. The benefits of using OPC certified products include faster configuration and start-up with fewer support calls, proven reliability and interoperability, minimal integration risks and an investment in quality.



MODBUS IP

Desigo CC support the MODBUS communication protocol, allowing for example a seamless integration of power meters at the management level.

DALI, EnOcean

DALI, EnOcean, and KNX devices turn the PXC3 room automation stations of Desigo TRA into a complete solution for the room. The optional DALI bus of the room automation stations allow for simple integration of different lamps and luminaires. DALI (Digital Addressable Lighting Interface) is a worldwide standard that applies specifically to lighting control at cost-efficient two-wire technology and integrated power supply. Self-powered EnOcean radio technology offers wireless connection of field devices based on extremely energy-saving technology. The operating energy required by the devices is taken directly from the environment. The wireless room units QAX9..4 can be used via EnOcean/LONWORKS or EnOcean/KNX gateway with Desigo TRA or RX.

S7 Protocol

Desigo CC integrates S7-300 and S7-400 natively, allowing the use of all standard workflows for also these Siemens devices.

Client/server options

The management platform Desigo CC offers flexible client-server architecture for building automation and fire protection applications. It supports the configurations of small single-user systems to large multi-user installations. Desigo CC can be fully installed on a computer, with full client and server functionality. Additional clients (dedicated with browser as well as Windows desktop application) can be easily added.

Desigo Touch and Web

Desigo Touch and Web permits operation and monitoring of the Desigo PX automation level using the Desigo touch panels PXM40 and PXM50, as well as via standard Web browser (HTML5 technology) on various hardware platforms (e.g. tablets, notebooks/PCs, smartphones). The BACnet/IP Web interface PXG3.W100 supports flexible and remote access to the BACS via LAN/W-LAN connections in a straightforward manner."

IT security

The protection against unauthorized or malicious access to building services systems and installations is becoming increasingly important. Desigo CC, as modern management platform takes this into account and meets security level SL1 according to ISA-99/IEC 62443. This includes securely handling of passwords with appropriate key strength and authorized system access only to elements (menus, buttons, etc.) to which the user has at least read access.

Connection of legacy systems

Desigo is compatible with the legacy automation systems Unigyr, Visonik, Integral or Simatic and allows their seamless integration. Changes in use, system extension and retrofit projects can all be handled in gradual stages. For example, previously installed PTM-I/O modules of Unigyr or Visonik can be connected directly to modular Desigo PXC..D automation stations. Existing actuators and sensors can continue to be used that way.

Management functions

2



Management functions

Desigo CC

2-2

Desigo Insight

2-11

Information management

2-14

Desigo CC sets new management platform standards

Desigo CC™ (Control Centre) is the latest Siemens high-performance management platform, based on 30 years of world-wide experience. Desigo CC software uses state-of-the-art technologies offering powerful, patented functionalities and capabilities for efficient management of your facility. A global expert design team developed the unique user interface and workflow concepts providing an easy and efficient way to operate, monitor, supervise, optimize and manage your building infrastructure. Desigo CC also ensures and prepares your installed systems for future migrations by offering Web client options to reduce maintenance costs over the life cycle of your facility. With its future-oriented and discipline-independent approaches, Desigo CC enhances and protects your investments today and in the future.

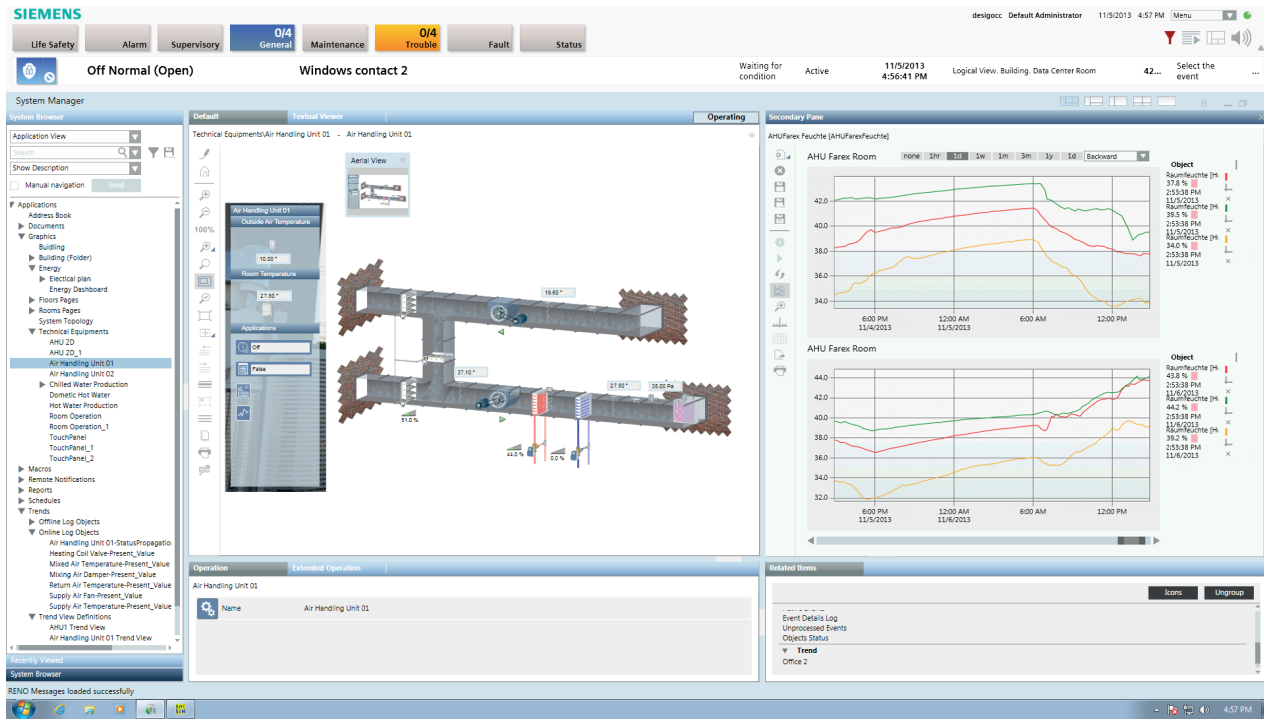

User Interface: System Manager

The Desigo CC management platform presents a single face to the customer for building automation, fire safety, mass notification and security systems, or a combination thereof. Offering scalability of all configurations and allowing needbased expansion from small and medium to large and complex systems, Desigo CC provides customer and market-specific solutions.

- Full integration of building automation, fire safety, intrusion, and live IP camera systems.
- Collect, view, analyze and compare trend information.
- Workflow-oriented user interface enables fast and accurate operation and event handling.
- Support for the leading open standards: BACnet, OPC, Modbus and SNMP
- Support of industry standard Siemens Simatic S7-300 / 400
- Support ONVIF Standard for IP Video cameras
- Desigo CC supports interfaces to EN54 compliant Fire Systems
- Fire Safety Standard (UL864 9th Edition, ULC-S527-11) for Fire Detection Units and Accessories
- Multiple client options for installed, browser-based and Windows-App-clients with the same user interface.

User Interface functionality allows for:

- Quick, easy, and accurate response to any events
- Enhanced event treatment and remote notification features
- Graphically monitor and control the site infrastructure
- Schedule and modify mechanical equipment operation
- Automatic and manual report generation
- Retrieval and analysis of historic data
- Graphic and report printing
- Alarm printing
- Online and remote configuration

Easy to Learn, Easy to Use

- Consistent interface designed around user-based workflows
- Simple navigation through tree views or graphics
- Auto-defined Related Items help anticipate your next step
- Drag-and-drop graphics creation
- On-line engineering to speed-up project commissioning time and to reduce system downtime

Smart Application for Better Decision Making

- Integrated data from multiple building and information systems
- Assisted Treatment and Investigative Event Management for fast response to critical events
- Customized reporting capabilities
- Time-shifted trend graphs for quick data comparison
- Powerful multi-layered graphics supporting animated symbols, import of AutoCAD plans.
- Built-in email and SMS for remote notification.

Adaptable to Meet the Needs of Any Facility

- Multiple client options for use at a dedicated workstation, in a browser, or as a light desktop application
- User groups and profiles control and simplify site visibility
- Built-in profiles for building automation and fire safety users
- Adjustable pane layouts support beginners and power users
- Separate operation and configuration modes
- Flexible Views organize facilities as users want to see them

Open, Integrated System

- Open protocol support for building automation, fire safety, and video systems
- Standard interface support for IT systems
- Normalization and management of data from multiple sources
- Integration application support for simple and complex systems

Robust System Platform

- Built on a proven SCADA technology and IT standards
- Scalable to support small and large facilities
- Flexible to provide a wide range of applications
- Extensible to grow with a facility's needs

Management functions

Desigo CC

System Manager

2

The System Manager is used for system navigation, to view and override current conditions, analyze historical operation, and to configure the system.

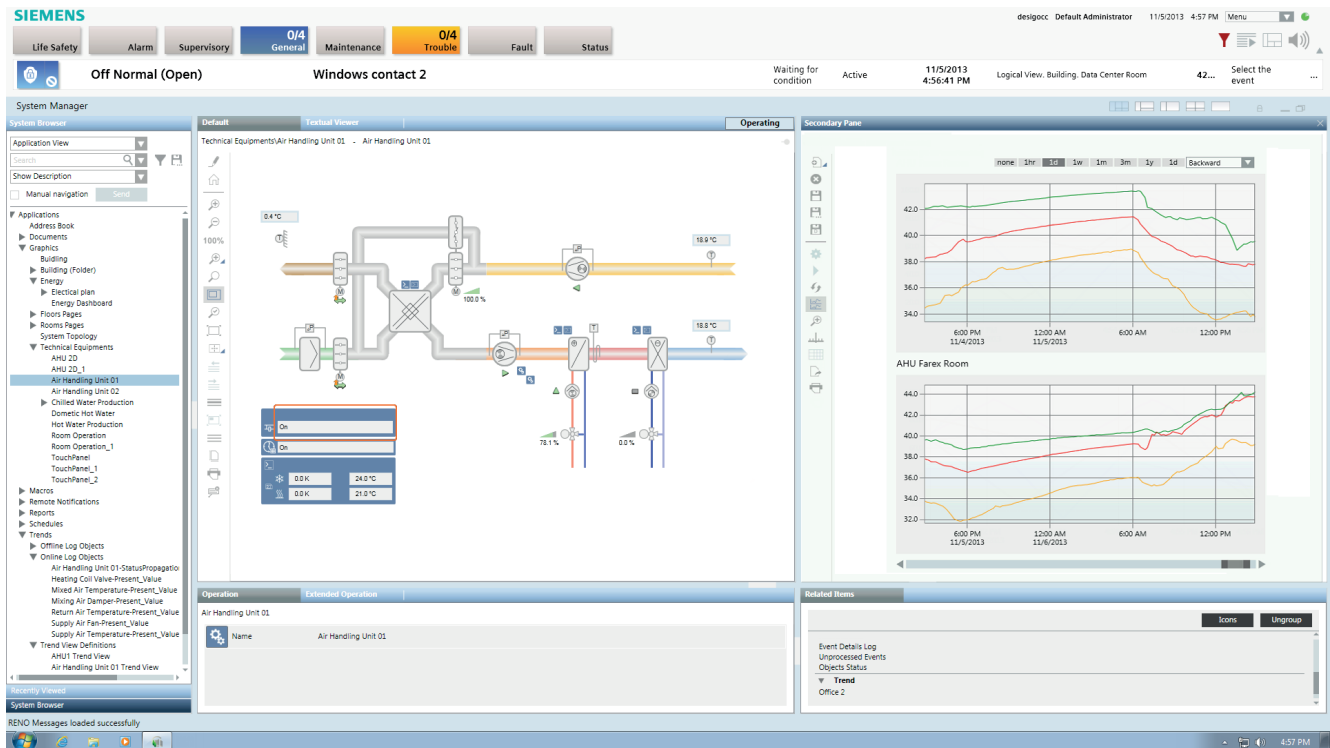

Navigation

The System Manager is built around the concept of a common workflow for all system navigation. This simple and consistent workflow allows users to select from traditional applications, or for a more specific focus, select the part of the facility they are interested in, and let the system guide them to the most relevant information.

From the initial starting point, users can make additional selections for more details, act on the system, or navigate further to automatically calculated Related Items based on their selection. The pane-based navigation keeps important information in front of users with no overlapping windows. They can navigate the system through graphics or flexible views that allow the system to be represented the way that users see their facility.

Graphics

Desigo CC graphics are built using smart objects that know how they are used and how to represent themselves graphically. The use of smart objects allows users to create graphics by simply dragging-and-dropping objects onto a page, without manually binding an object to graphical symbols.

Desigo CC also provides a powerful AutoCAD importing tool that allows you to select and manipulate layers of AutoCAD drawings both during and after the import process.

Textual Viewer

The Text Viewer provides a quick summary of the current value and status of any selected object(s) without any prior system configuration. This is a handy tool for getting an overview of system status.

Trending

Both panel-based and workstation-based trending is provided to support control systems without embedded trend capabilities. Trend data is stored in a Microsoft SQL Server database. SQL Server Express is included with the Desigo CC software. The Trend Comparison View allows users to time shift the trend view to compare data at different times for quick analysis of changing conditions.

Log Viewer

The Log Viewer application provides an historic log of all user and system events and activities that have occurred and allows users to retrieve these historic events and activities for further analysis and investigation.

Detailed Log

A Detailed Log is available allowing users to view the most recent records for a selected object.

The same column and content filtering and sorting functionality available in the Log View is possible in the Detailed Log.

Printing

Printing functionality is offered for printing of reports including graphics and trends. Journaling printing is also available for alarms and events.

Schedules

The Scheduling application allows complete configuration and monitoring of standard BACnet schedule, calendar, and command objects, as well as for workstation-based schedules that can be used to support systems without built-in scheduling capabilities. Schedules are automatically associated to systems they control, so users can quickly navigate to schedules related to any selected object.

Timeline Viewer

Timeline Viewer allows users to view the details of multiple management platform and field panel schedules simultaneously, spanning a range of time.

Macros

Macros are predefined lists of commands that enable a user to send out a group of commands to specified devices with a single action. Some macros can be started manually while others may be part of schedules defined for time-based functions or automatic reactions. Macros are also used by the system to perform multiple command actions. These predefined system macros are applied to specific control actions, such as block commands to fire control panels and system backup functions.

Reaction Processor

Reactions can be configured in Desigo CC in order to initiate system actions when a specific alarm or event or condition is fulfilled. An example of a system reaction could be that the camera moves to show the area of the door which just opened.

Reports

The Desigo CC reporting tool includes standard reporting templates and allows a user to create fully configurable reports with custom logos, headers, footers, and layouts that include tabular and graphical system information. Reports can be scheduled, and saved in CSV or PDF formats for future use.

Operating and Engineering Mode

The System Manager provides two distinct modes of behavior for system operation and engineering. *Operating Mode* allows users to simply navigate the system to view and override current conditions, and analyze historical operation, without the complexities of managing system configuration.

Users that are granted privileges for system configuration can toggle the System Manager into *Engineering Mode* where they can setup system parameters and manage user accounts. The same common workflow is used in both Operating and Engineering modes.

Web Services

Using RESTful technology, Desigo CC provides alarm, object and time series data via web based services to supervision management platforms or other 3rd party external applications.

Mobile App

Desigo CC provides a Mobile App for alarm monitoring and system operation. The Mobile App „Desigo CC“ is available for Android and iOS via Google Play and iTunes.

Desigo Eco Monitoring

Desigo CC supports graphical display, reporting and KPI adjustment of the Desigo PX Eco Monitoring feature. It provides fast and easy analysis of mechanical equipment efficiency.

Management functions

Desigo CC

Event Management

2

Desigo CC provides a robust set of applications to ensure quick, easy, and accurate response to any event.

The screenshot shows the Desigo CC Event Management interface. At the top, there is a summary bar with status indicators: 0/5 Life Safety, Alarm, Supervisory, General, Maintenance, 1/5 Trouble, 0/4 Fault, and 0/3 Status. Below this is the 'Event List' table.

Case	Source	Counter	Commands	Information	Event Status	Source Status	Date/Time	Location
Device Return	BG FC20 Panel 1	4			Unprocessed	Quiet	2/17/2012 2:05:45 PM	ManagementView: FieldNetworks: F200F4System: BACNet
Low Limit	MEC10_RM100_RMTMP [RM 100 RMT...				Waiting For Condition	Active	2/16/2012 12:21:59...	ManagementView: FieldNetworks: BACNetwork_1: Hardware: MEC10: Local_IO
Low Limit	MEC10_RM100_EE1_FLOATINGLIMIT				Waiting For Condition	Active	2/16/2012 12:21:59...	LogicalView:MEC10_RM100EE1
Low Limit	My Description2				Waiting For Condition	Active	2/16/2012 12:22:01...	LogicalView:Local_IO
Low Limit	RoomTempAlarm				Waiting For Condition	Active	2/16/2012 12:22:01...	LogicalView:Local_IO
Low Limit	MEC10_RM100_EE2_OUTOFRANGE				Waiting For Condition	Active	2/16/2012 12:22:01...	LogicalView:MEC10_RM100EE2
Low Limit	MBC05_LAO PT (EE_1_216879)				Waiting For Condition	Active	2/17/2012 2:03:47 PM	Desigo CC: Field Networks: BACNet Network 1: Hardware: MBC05: Local_IO
Trouble IN (Fault)	Power supply superv_ & batt_charger				Ready to be closed	Active	2/16/2012 12:00:13...	Desigo CC: Field Networks: BG T85 F520 Fire System: Hardware: Panel 3
Trouble IN (Fault)	Power supply superv_ & batt_charger				Ready to be closed	Active	2/16/2012 12:00:13...	Desigo CC: Field Networks: BG T85 F520 Fire System: Hardware: Panel 3
Trouble IN (Fault)	NODE 2 MAIN MOTHER BOARD				Ready to be closed	Active	2/17/2012 11:41:33...	Desigo CC: Field Networks: XNET Fire System: MXL - MXL NODE #2
Trouble IN (Fault)	NODE 1 MAIN MOTHER BOARD				Ready to be closed	Active	2/17/2012 11:41:33...	Desigo CC: Field Networks: XNET Fire System: MXL - MXL NODE #1
Station not reachable (False)	WebClient				Waiting For Condition	Active	2/10/2012 1:56:06 PM	Desigo CC: Management System: Clients
Not reachable (True)	LinePrinter				Waiting For Condition	Active	2/16/2012 2:43:05 PM	Desigo CC: Management System: Servers: MainServer
Fault	BTEC01-RoomTempEE				Waiting For Condition	Active	2/17/2012 9:53:08 AM	Desigo CC: Field Networks: BACNet Network 1: Hardware: MEC01: Local_IO
Station not reachable (False)	Emanuele PC				Waiting For Condition	Active	2/17/2012 2:32:02 PM	Desigo CC: Management System: Clients
Advisory (Active)	IC Trouble				Waiting For Condition	Active	2/16/2012 12:00:13...	Desigo CC: Field Networks: BG T85 F520 Fire System: Hardware: Panel 3
Advisory (Active)	IC Trouble				Waiting For Condition	Active	2/16/2012 12:00:13...	Desigo CC: Field Networks: BG T85 F520 Fire System: Hardware: Panel 3
Printer offline (True)	LinePrinter				Waiting For Condition	Active	2/16/2012 2:43:05 PM	Desigo CC: Management System: Servers: MainServer

User Interface: Event List

Client Profiles

To ensure the correct level of event management support for users in any situation, a workstation and/or users can be easily assigned predefined profiles supporting casual, intermediate, or dedicated event notification and management.

Summary Bar

The Summary Bar is the anchor of Desigo CC event management. It highlights current conditions with clear indication of current event priorities, and allows the user to quickly open the Event List. Depending on the client profile in use, the Summary Bar can be docked on the desktop or freely opened and closed as needed.

Event List

The Event List provides a complete and easily filtered list of events under control of the management platform. When the Event List is expanded, it gives a clear indication of each event source, severity, and current status, as well as custom messages and suggested action steps through the use of text, color, and icon representations. Events can be acknowledged, silenced, and reset from the Event List.

Event Bar

When using profiles for critical event management, the Event List can be collapsed into a condensed list of event buttons in an area called the Event Bar, that remains docked on the desktop for easy access. This patented design keeps current situations in focus at all times.

Fast Treatment

From the Event List or Event Bar, operators can quickly select an event and perform all the commands (for example, Acknowledge, Reset, Close or Suspend) from the Event Detail Bar and Event List, without looking at treatment steps, viewing live video or a map of the alarmed area, and so on. A brief description of the next action to take (which command to select) is also contained in the event descriptor (the event descriptor is visible when the Event List is expanded). When event treatment is in progress, you can send the available commands to the source object causing the event or suspend treatment.

Investigative Treatment

From the Event List or Event Bar, operators can quickly open the System Manager with focus on the source of the event, and all information (live video, recent history, schedules, and so on.) related to the event source.

Assisted Treatment

Assisted Treatment guides a user through a sequence of steps or actions.

From the Event List or Event Bar, operators can quickly open the Assisted Treatment to guide them through a pre-configured Operating Procedures. Each Operating Procedure is composed of steps - some of which may be mandatory.

Remote Notification

Alarm and event forwarding to a configured email address, SMS to a mobile phone or pager (ESPA 4.4.4). The remote notification of Desigo CC includes two levels of escalation in case that the first recipient does not react on the alarm notification.

System Openness

Designo CC is an open system by design and supports a variety of open system protocols and IT standards.

- **BACnet**
BACnet Revision 1.13, certified by BACnet Testing Laboratory as BACnet Advanced Workstation Software (BTL B-AWS)
- **OPC Client**
Data Access specification DA 2.0
- **OPC Server**
Data Access specification DA 2.05/3.00; Unified Architecture specification UA 1.01
- **Modbus**
Modbus TCP
- **Siemens S7**
Siemens Simatic S7-300 / 400
- **SNMP Version 2**
IP device monitoring
- **ONVIF**
IP Video Cameras
- **WMI**
Computer hardware monitoring
- **SMTP, POP3, IMAP, SSL/TSL**
For sending and receiving emails
- **Microsoft SQL Server**
History data storage
- **HTTP(S)**
Client-server communication
- **DWG, DXF**
AutoCAD import formats till version 2012 supported
- **WebServices**
RESTful Technologie
- **IPv6 ETHERNET communication**

Integration Support

Representative data points in Designo CC can be created manually, imported through data exchange files, or uploaded through a selective auto-discovery mechanism depending on the type of system being connected. A unique, extensible object modeling approach allows Designo CC to normalize information brought in through any interface, and to provide the same look, feel, and operation through a common set of applications, without concern for the source of the data.

As a true integration platform, Designo CC allows you to configure connected subsystems directly, as well as perform typical controller functions (such as scheduling, event generation) at the management platform for connected systems that do not support those functions directly.

Management Platform for Building Automation

As a building automation management platform, Desigo CC provides a full breadth of application support for ensuring that facilities remain comfortable, productive, and achieve optimal energy and equipment performance.

The Desigo CC user interface, coupled with standard protocol support, integration capabilities, and multiple client options that allow full operation and configuration from anywhere, make Desigo CC the perfect tool for maintaining facility operation.

Management Platform for Fire Safety and Security

As a Fire Safety management platform, Desigo CC is designed for use with fire safety and security systems offering users enhanced event management including:

- Acknowledgment, silence, and reset events
- Include and Exclude (isolate/de-isolate) system devices
- Send out automatic remote notifications (RENO) of responders through email
- Provide Operating Procedure checklists for operator guided event treatment
- Continuous displayed most recent, highest priority events
- Direct navigation to event trigger element (one click)
- Distributed event management across multiple Desigo CC management platforms

Management Platform for Combined Systems

As an integration platform, Desigo CC is designed for a simultaneous connection to multiple systems and use by multiple operators, each with their unique focus. With Desigo CC you can be assured of optimal system performance of building automation and fire life safety and mass notification applications.

The workflow-oriented user interface provides the same look, feel and operation to all connected subsystems. This brings integration to the next level, a unification where tasks are not differentiated by the subsystem. As an open system, Desigo CC unifies workflows and user interfaces for supervisory tasks such as commanding, event handling, reporting, and scheduling.

Approvals and Certifications

- BTL Listed as B-AWS device.
- IT security compliant with the ISA-99/IEC 62443 Security Level: SL1+
- UL Listed to UL864 9th Edition Standard for Fire Safety Units and Accessories (when installed on a UL-approved PC)
- OPC Foundation certified OPC Server

Supported Operating Systems

Server, FEP and Installed Clients

- Microsoft Windows 7, 64-bit
- Microsoft Windows 8.1, 64-bit
- Microsoft Windows Server 2008 R2
- Microsoft Windows Server 2012 R2

Windows App Clients (with Internet Explorer IE 9 / 10)

- Microsoft Windows 7
- Microsoft Windows 8.1

Designo CC is a flexible full client-server architecture for building automation and fire safety applications allowing configurations from small single-seat to large multiuser installations. Designo CC can be installed completely on one computer, with full server and client functionality. Additional Installed, Web, and Windows App (ClickOnce) Clients can also be added. Additional system connections can be made through systems installed with a Designo CC Front End Process (FEP) configuration. An IIS server for Web Clients and Windows App Clients can be installed on the Designo CC server or on a separate installation (Web Server).

The server hosts all the data for the system, while the clients are only for the visualization and the user interaction. The clients provide a high-resolution interface to all the relevant server data needed for monitoring and to command the installation.

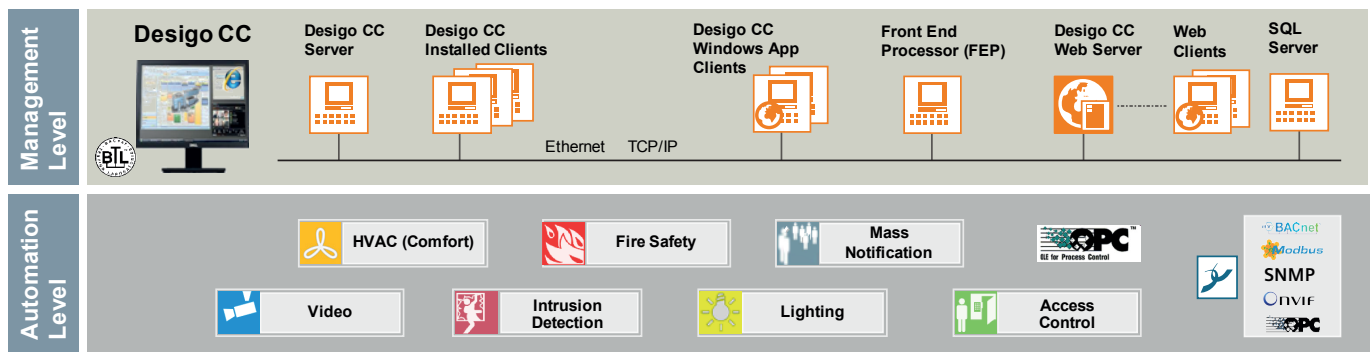

Main Server

A Designo CC architecture supports one project server: the main server. The main server contains the project database and the software that monitors and commands the system network. Clients connect to this server to monitor and control the facility. If the same computer runs Internet Information Server (IIS), the installation provides web clients with access to the facility. Note that the Designo CC server installation always includes an installed client too, providing the user interface used to monitor and control the facility. For a small application it is common to have one single computer acting as server and client, while for medium to large installations, the server PC is dedicated to server activities only. The main server is the computer where the core system services run, and where the project databases reside. It has interface connections to the field (either directly or using FEP) and provides a centralized database and other services to the connected clients. The main server can support a number of clients that are connected using a network (LAN) or Intranet (WAN).

Web Server

The Web Server allows you to access the system using the customer’s intranet, using a Web browser. It allows downloading all files required for the Web Client and Windows App Client environments. It provides a system web page to access the Web Client, the Windows App Client, and the system documentation in the Internet Explorer browser. It also represents the endpoint of the communication with the System Server.

Front End Processor

A Front End Processor (FEP) is a computer that provides additional connections between building level devices (such as field panels) and the Designo CC system. By providing additional connections to the building level network, a FEP enables load balancing for the network-based processing for a Designo CC system.

SQL Server

Designo CC uses the Microsoft SQL database software. SQL Express is included on the product installation DVD. Alternately, you can use an existing SQL Server installation (same version 10.50.4000.0). In this case, the Designo CC Installer will skip the SQL Server installation. In both cases, SQL must first be installed and running on the computer where the Designo CC Main Server will be installed. The purchaser of the Designo CC must ensure that the MS SQL server is properly and correctly licensed.

History Database (HDB)

The history database (HDB) is used to log a wide range of user and system activities and guarantees storage of the following data:

- User activities in the system
- Alarms and their treatment
- Faults that have occurred and are handled as batch messaging
- Type of values logged in trend

For details about the range of logged user activities and system events please refer to the Designo CC product documentation.

Desigo CC supports multiple client options for applications ranging from casual users to dedicated mission-critical console installations. All client options are built around the same usability standards and capabilities making it easy to switch between different client options without needing to learn multiple interfaces.

User privileges can be assigned to users and to workstations, allowing users to be granted the same access from everywhere or different access depending where they're logged on.

Installed Client

The Installed Client is designed for mission-critical applications, such as fire safety monitoring or critical process control, where users are focused entirely on monitoring and managing building systems. In this configuration, software components used for Event Management are locked in place and cannot be moved or covered by other applications; this ensures that critical events are never missed or hidden. Installed Clients can optionally be configured to run in a Closed mode where only Desigo CC and other specifically identified applications are allowed to run. In Closed mode, the workstation is dedicated to running Desigo CC, with access to the Start Menu or other operating system and customer applications available only to administrative users.

Web Client (Browser Client)

This type of client is deployed on the Intranet with full trust and allows access to local resources. The system runs in the Internet Explorer Browser (using HTTP as communication protocol) and is downloaded on demand each time the user launches the system as Web application. When working in a browser, you can have the same capabilities as those working on an Installed Client, or can be restricted to have different access when connected remotely.

As Web Clients require low latency and high network bandwidth, these are appropriate for Intranet application. Not recommended for Internet use.

Windows App Client (ClickOnce)

The Desigo CC Windows App Client looks like the standard system software, but is a light application that can be downloaded from the Desigo CC server when connecting through a browser. When the Windows App Client is downloaded, it runs like any other Windows application on the desktop. It can be launched from the Start Menu, desktop icon, Quick-launch toolbar, and so on. This deployment does not require administrative privileges.

The Windows App Client runs in its own pane, without the overhead of the Internet browser application and menus.

Each time the user launches Desigo CC as Windows App Client, a search for system updates is performed. If a new version of the system is available on the Web Server, the user can choose to update it or continue to use the current version.

Supported Subsystems and Compatibility

Market Region Europe

- Desigo Building Automation system (Desigo PX V5.1 SP; V6)
- Desigo Total Room Automation system (TRA V1.16; V1.2)
- Simatic S7 (S7-300; S7-400)
- Siclimat-X V4.1
- Sinteso Fire Safety System (FS20 EN MP5.2; FS20 DE MP5.2)
- Sinteso Fire Safety System (STT20 Centralisateur de Mise en Sécurité Incendie)
- Intranet Intrusion System (SPC MP3.4, connections using TCP-IP or UDP-IP supported)
- Video through Milestone Video Management System
- Mass Notification System (Version 2.0) for a list of compatible Mass Notification devices, please refer to the MNS documentation
- 3rd party Building Automation and Fire Safety systems based on BACnet/IP
- 3rd party subsystems through OPC (OPC DA V2.05/V3.00 standard)
- 3rd party subsystems through Modbus/IP
- Integration through SNMP

Other Market Regions

- APOGEE Building Automation system (Apogee BACnet V3.1.2; V3.2.4; V3.3; V3.4)
- XNET FireFinder XLS and MXL fire safety systems (FireFinder XLS V8 and newer)
- Desigo Fire Safety FS20 UL systems (FS20 UL MP1.x, MP2.0)

The clearly structured, modular and object-oriented software of the Designo Insight management station is optimized to the current operating systems including Windows 7 and Windows 8.1 (business versions) or Windows Server 2012 featuring 64-bit technology. The functional scope and ease of use of the software reduces operating costs and familiarization time while maintaining operational reliability. The Designo Insight applications are introduced below:

Applications in Designo Insight

- **Plant Viewer:** Realistic plant graphics allowing fast, targeted monitoring and operation of the system
- **Scheduler:** Central programming of all time-controlled building services functions
- **Alarm Viewer:** Detailed overview of alarms to quickly localize and eliminate errors
- **Alarm Viewer Fire Safety:** Detailed overview to quickly assess fire detection system alarms
- **Alarm Router:** Flexible routing of alarms to printers, fax machines, mobile phones and e-mail
- **Trend Viewer:** Convenient analysis of trend data to optimize operations and increase energy efficiency
- **Report Viewer:** Snapshot queries to meet customers' needs and their display in reports. Reports provide information on plant operation analysis as well as evaluation and documentation purposes
- **Object Viewer:** An efficient tool for navigation through the hierarchical tree structure to all the data points in the system. These points can then be read or manipulated, depending on the access rights of the user concerned
- **Log Viewer:** Alarms, errors and user activities are logged in chronological order and can be displayed for further evaluation, as needed
- **Eco Viewer:** Fast and easy analysis of the efficiency status of primary plants
- **Database Audit Viewer:** Log unauthorized changes in databases (audit trail) guaranteeing the highest possible data integrity
- **Reaction Processor:** System-wide monitoring of plants and processes based on certain criteria (events). The reaction process triggers predefined (re) actions when one (or a combination) of the criteria are met. Allows for centralized time control of plants without scheduler programs/calendar functions
- **System Configurator:** Used to configure the general setup of the Designo Insight management station and associated applications
- **Graphics Builder:** Efficient creation of customized plant graphics
- **Online operator tools** for existing systems

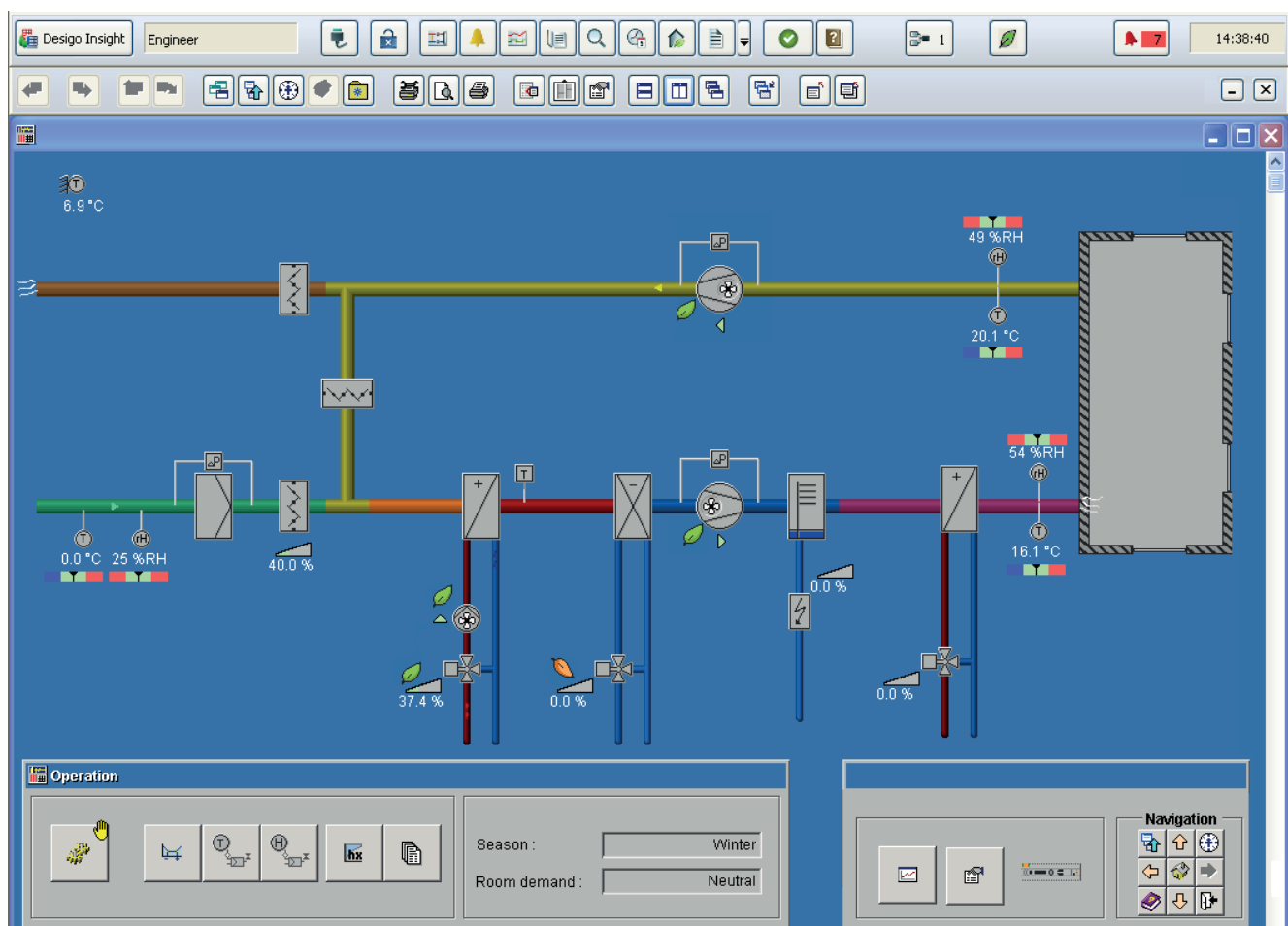

Plant Viewer

Designo Terminal Server

Designo Terminal Server provides all the functions of the management system in the form of terminal services over the network. These services can be accessed simultaneously by different users in independent sessions. In addition to the operation and monitoring programs for day-to-day operation of the plant, engineering tools are also provided, allowing modification and extension of the system while it is running.

This makes the Designo Terminal Server the optimum solution for professional facility managers who need unrestricted access to building data via their intranet or extranet, from any location. All the user requires is a simple, standard network-compatible terminal device such as a PC, Net PC or Web pad with a Microsoft operating system, without other installed software components (Thin Client).

Security is a top priority: Remote access from client devices is via Microsoft Remote Desktop Web Connection with the highly encrypted Remote Desktop Protocol (RDP) 5.0 which uses RSA Security's RC4 cipher with the option of 40-, 56- or 128-bit encryption.

Designo Terminal Server is based on the Windows Server operating system with the Terminal Server component and runs on standard server hardware. The hardware and software specification depends on how intensively it is used, with the number of users requiring simultaneous access being a decisive factor.

Designo Web

Designo Web is a genuine Web solution based on Microsoft IIS (Internet Information Server). The programs for operation of the management system are mapped to ASPs (Active Server Pages) in special interfaces optimized for current Web browser versions of Microsoft Internet Explorer and Firefox.

Functions in Designo Web

- Operation of graphics (Plant Viewer)
- Operation of data points (Object Viewer)
- Alarms and log (Alarm Viewer, Log Viewer)
- Trend data (Trend Viewer)
- Schedules (Scheduler)
- Report Viewer

This makes Designo Web the optimum solution for those responsible for technical services (such as the caretaker, facility manager or security staff) that track the day-to-day operation of the building and need easy access to all the key functions. In addition, it makes new options available, enabling selected building data and user access to be allocated relevantly to tenants and users of the building (e.g. room operation, schedules and display of room conditions).

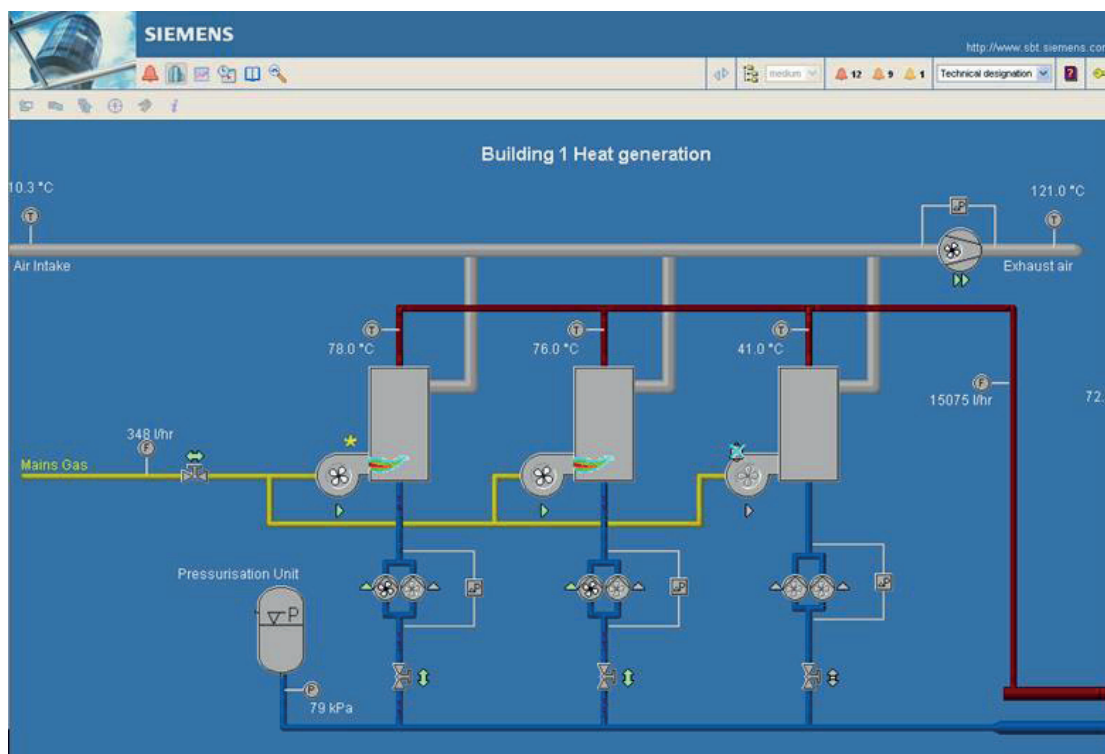

Web Plant Viewer

Energy reports

Energy Reports can easily check a building for energy efficiency based on predefined reports. The data evaluation and reporting program guarantees gap-free processing and presentation of all operational data.

The high availability and optimum use of building services plants are very important. In pursuit of this goal, Energy Reports represents a basic requirement.

Energy Reports compiles powerful reports from the data stored in the process data management database in any number of combinations and selectable periods. The reports can be displayed and printed in various forms.

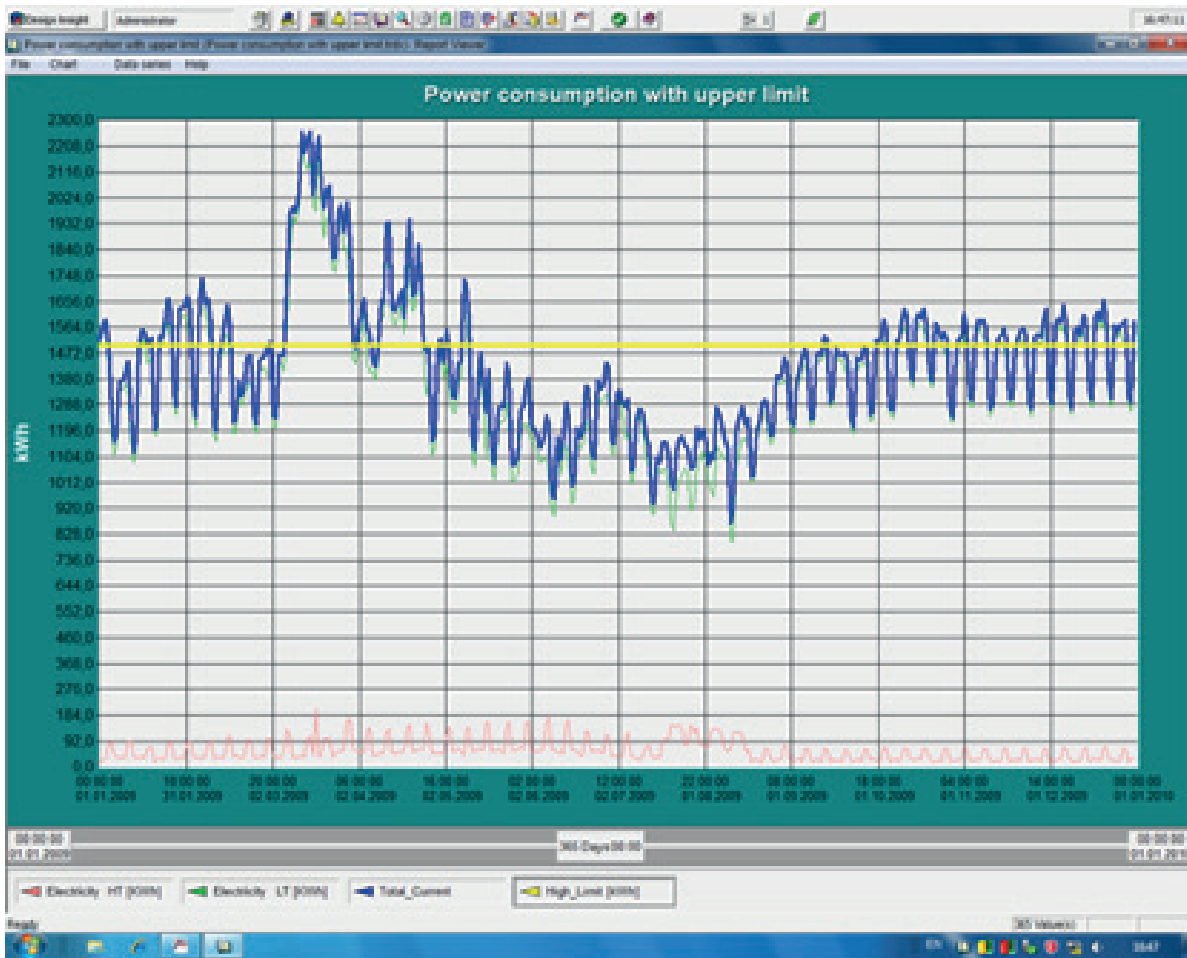

Example of a line graph showing the metered energy consumption and the comparative values of the previous year.

Energy Reports focuses on the powerful presentation of consumption data.

- The following report templates are available to efficiently create Energy Reports:
 - Energy consumption report
 - Energy cost report
 - Weighted consumption report
 - Corrected heating degree day report
 - Energy benchmark report
 - CO₂ benchmark report
- Multiple reports can be generated and stored for each report type
- Up to 10 data series per report are possible
- Comparison reports with previous years (1-2 years)

Automation Controls



Overview and selection tool	System topology	3-2
	Overview	3-3
Automation stations	Compact series PXC..	3-7
	Modular series PXC..D	3-10
	PX System Controller	3-12
	Designo PX Open	3-14
	Designo NET	3-17
	Integral migration PXC-NRU..	3-18
	Operator units	Operation and monitoring: PXM.. / PXG3.W100
Designo TX-I/O	I/O Module TXM..	3-24
	Designo TX Open	3-29
	Accessories Designo TX-I/O	3-30

Automation functions

Overview and selection tools

Overview of product details

Designo™ Overall topology

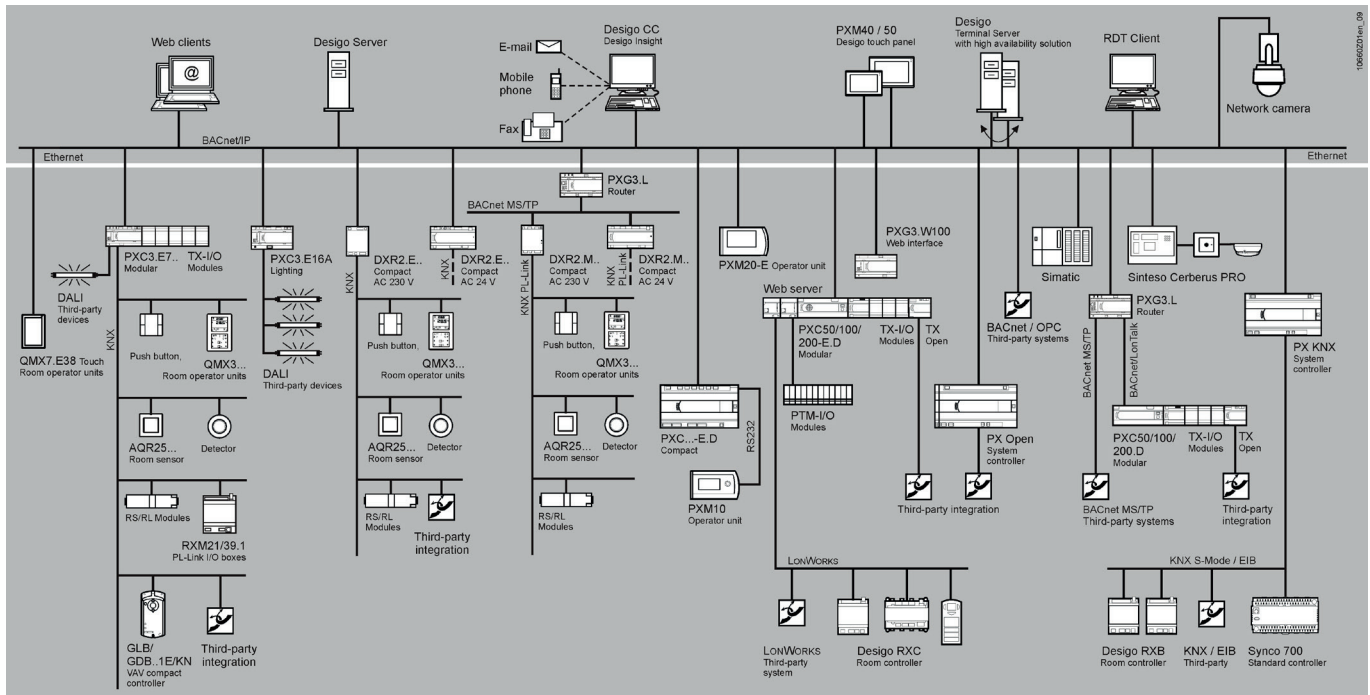

One of the key benefits of Designo™ is its seamless expansion capability, starting from the smallest system up to comprehensive and distributed large systems.

Freely programmable automation stations

Designo PX offers maximum flexibility with freely programmable automation stations for primary plants. This way, building services plants can be optimally controlled and monitored. Comprehensive system functions such as alarms, time scheduling and trend data storage cover all the requirements associated with the operation of a building. The distributed automation stations, available as modular and compact series, operate autonomously.

Designo PX excels in consistent openness of the system and the scalability of its freely programmable automation stations and operator units, making cost-effective DDC technology a possibility even in smaller HVAC systems. Whether for new buildings or modernization projects, investment costs are limited to the system components that are actually needed.

Maximum openness

The consistent and coordinated use of standards like BACnet, KNX, LonWorks or AMEV emphasize the openness of Designo for maximum overall efficiency. The native BACnet automation stations offer a multifunctional integration platform used to connect third-party automation stations and open field-bus networks to the BACnet network. A few decentralized, distributed third-party devices can be connected quickly and cost-effectively via Designo TX Open and processed in the automation system.

A range of graded operator units

Building users and facility managers benefit from a comprehensive range of touch panels and operator units which can be used for targeted modification of comfort conditions or of the whole plant.

Especially ergonomic finger operation of the PXM40 (10 inch) and PXM50 (15 inch) Designo Touch and Web permits complete operation of Designo PX automation stations via the BACnet/IP Web interface PXG3.W100.



Overview of modular PX automation stations and PX system controllers

	PX Automation station series		PX System controllers	
	modular PXC50/100/200..D	compact PXC12/22/36..D	PXC00..D	PXC001..D
Alarms	■	■	■	■
Time schedules	■	■	■	■
Trend	■	■	■	■
Programming with D-MAP	■	■	■	■
Inputs / Outputs	I/O Module TXM1..	onboard		
Subsystem via Island bus	TX Open			
Subsystem	LonWorks via PXX-Lxx I/O Module PTM.. via PXX-PBUS		LonWorks via PXX-Lxx	Modbus, M-Bus, KNX, ...
Operating / Web				
Web Interface	■	■	■	■
Touch Panel PXM50	■	■	■	■
Touch Panel PXM40	■	■	■	■
PXM20	■	■	■	■
PXM10	■	■		
QAX3x		■		

Overview of inputs and outputs of compact PXC.. automation stations

	PXC12.D	PXC22.D	PXC36.D
BACnet / LONTALK			
BACnet / IP	PXC12-E.D	PXC22-E.D	PXC36-E.D
Number of I/Os complete	12	22	36
Universal inputs outputs, number	8	18	24
Digital inputs, number	2	0	4
Digital outputs, number	2	6	8

Automation functions

Overview and selection tools

Overview of product details

Overview TX-I/O™ module range TXM1..



3

Type	TXM1.8D	TXM1.16D	TXM1.8U	TXM1.8U-ML	TXM1.8X	TXM1.8X-ML	TXM1.6R	TXM1.6R-M	TXM1.8P	TXM1.6RL	TXM1.8T
Number of I/Os	8	16	8	8	8	8	6	6	8	6	8
Functionality											
Local operation				■		■		■			
LC-Display				■		■					
3-colored I/O status LED	■							■			
Green colored I/O status LED		■	■	■	■	■	■		■	■	■
Digital inputs (DI)											
Message signal (open/closer)	■	■	■	■	■	■					
Message impulse	■	■	■	■	■	■					
Counter 10 Hz (with debouncing)	■	1-8 ¹⁾									
Counter 25 Hz (Bouncer free)			■	■	■	■					
Analog inputs (AI)											
LG-Ni1000			■	■	■	■			■		
Pt 1000 / 0...2500 Ohm			■	■	■	■			■		
T1			■	■	■	■					
DC 0...10V			■	■	■	■			■ ³⁾		
4...20 mA / 0...20 mA					■	■			■ ⁴⁾		
Analog outputs (AO)											
DC 0...10 V			■	■	■	■					
4...20 mA					5-8 ²⁾	5-8 ²⁾					
Digital outputs (DO)											
Continuous contact on/off							■	■			
Continuous contact, 3-stage							■	■			
3-stage output							■	■			
Impulse on/off, 3-stage							■	■			
Multistate							■	■			
Triac-continuous contact											■
Triac-impulse (3-stage)											■
Triac pulsewidth-modulated											■
Light control, bistable										■	

All I/O points of a module are configurable on any, implemented functionality. The module TX1.OPEN enables the integration of Modbus, M-bus etc. via RS232 on the PXC50/100/200..D.

¹⁾ On the TXM1.16D the counters are implemented only on the inputs 1 to 8

²⁾ On the TXM1.8X.. the current exists 4...20 mA are implemented only on the I/Os 5 to 8

³⁾ 0...250 Ohm

⁴⁾ Pt100 4-wire

Desigo Touch and Web

Desigo Touch and Web permits convenient operation and monitoring of complex building-technical plants via touch panels as well as standard Web browsers (HTML5-technology) on various hardware platforms (e.g. tablets, notebooks/PCs, smartphones). The Web interface PXG3.W100 serves as a central access point for the operation of the automation level.

Operating functions

- Graphical display of plants with intuitive operation
- Object display and operation including all actual values and setpoints, plant and operating states via dialogs
- Graphical display and operation of scheduler programs, exception calendar (in profile and list view)
- Alarm monitoring with acknowledgement
- Graphical display of offline trend data (trendlog objects)
- Export of trend data
- Favorites for the most important plant data
- Log on and off via Desigo user profile
- Plant overview of the most important plant values, even without log on
- Display automatically adjusts to the size of the given client

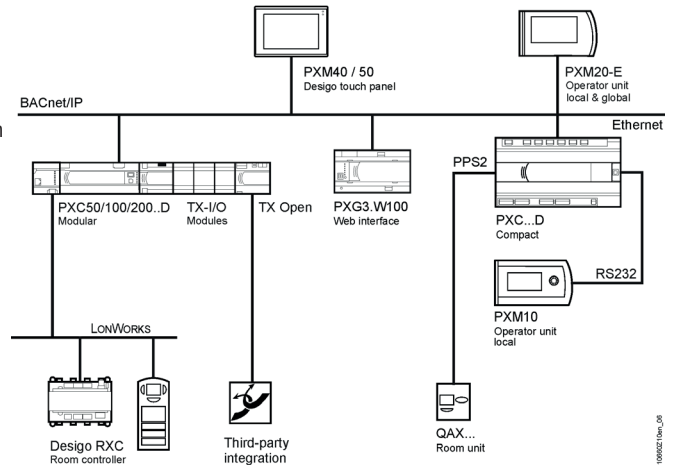

Product overview

PXM40	Desigo touch panel with 10.1 inch screen diagonal
PXM50	Desigo touch panel with 15.6 inch screen diagonal
PXG3.W100	Web interface BACnet/IP

PXC..D



3

Automation station, compact series

Compact, freely programmable automation stations for HVAC and building services plant. The fixed data point mix makes the automation stations ideal for commonly used applications with standard signals.

- Direct connection of field devices
- Management functions (alarm management, scheduler programs, trend functions, remote management, access protection, etc.)
- Standalone application or for use with linked system or devices
- Connection of the PXM.. operator unit
- Connection of QAX.. room units
- BTL tested BACnet communication on LonTalk, PTP or IP according to BACnet standard (rev 1.12 - as of Desigo V6.0) include B-BC profile
- AMEV profiles AS-A and AS-B according to guide line "BACnet 2011 - Version 1.2 (as of Desigo V6.0)"

Data sheet	N9215
Communication	Bus: BACnet / LonTalk, PTP (point to point) or IP Room unit: PPS2
Universal inputs/outputs	Configurable software
Digital input, contact query	7 mA DC 20...25 V
Relay outputs	Monostable, changeover contact

Automation station with 12 data points and BACnet on LonTalk

Fixed data point mix for 12 physical data points per automation station.

PXC12.D

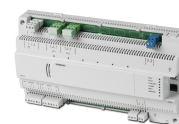

Data sheet	N9215
Operating voltage	AC 24 V
Frequency	50/60 Hz
Power consumption	24 VA
Communication	Bus: BACnet on LonTalk Room unit: PPS2
Universal inputs/outputs, number	8
Digital inputs, number	2
Digital outputs, number	2
Dimensions (W x H x D)	272 x 150 x 62 mm

Stock No.	Product No.
BPZ:PXC12.D	PXC12.D

Automation station with 12 data points and BACnet on IP

Fixed data point mix for 12 physical data points per automation station.

PXC12-E.D

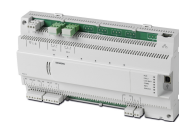

Data sheet	N9215
Operating voltage	AC 24 V
Frequency	50/60 Hz
Power consumption	24 VA
Communication	Bus: BACnet on IP Room unit: PPS2
Universal inputs/outputs, number	8
Digital inputs, number	2
Digital outputs, number	2
Dimensions (W x H x D)	272 x 150 x 62 mm

Stock No.	Product No.
BPZ:PXC12-E.D	PXC12-E.D

Automation controls
Automation stations
Compact series PXC..

PXC22.D



Automation station with 22 data points and BACnet on LonTalk

Fixed data point mix for 22 physical data points per automation station.

Data sheet	N9215
Operating voltage	AC 24 V
Frequency	50/60 Hz
Power consumption	26 VA
Communication	Bus: BACnet on LonTalk Room unit: PPS2
Universal inputs/outputs, number	16
Digital outputs, number	6
Dimensions (W x H x D)	272 x 150 x 62 mm

Stock No. Product No.

BPZ:PXC22.D PXC22.D

PXC22-E.D



Automation station with 22 data points and BACnet on IP

Fixed data point mix for 22 physical data points per automation station.

Data sheet	N9215
Operating voltage	AC 24 V
Frequency	50/60 Hz
Power consumption	26 VA
Communication	Bus: BACnet on IP Room unit: PPS2
Universal inputs/outputs, number	16
Digital outputs, number	6
Dimensions (W x H x D)	272 x 150 x 62 mm

Stock No. Product No.

BPZ:PXC22-E.D PXC22-E.D

PXC36.D

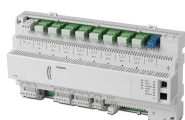

Automation station with 36 data points and BACnet on LonTalk

Fixed data point mix for 36 physical data points per automation station.

Data sheet	N9215
Operating voltage	AC 24 V
Frequency	50/60 Hz
Power consumption	35 VA
Communication	Bus: BACnet on LonTalk Room unit: PPS2
Universal inputs/outputs, number	24
Digital inputs, number	4
Digital outputs, number	8
Dimensions (W x H x D)	293 x 176 x 77 mm

Stock No. Product No.

BPZ:PXC36.D PXC36.D

PXC36-E.D

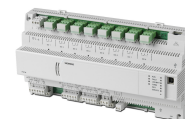

Automation station with 36 data points and BACnet on IP

Fixed data point mix for 36 physical data points per automation station.

Data sheet	N9215
Operating voltage	AC 24 V
Frequency	50/60 Hz
Power consumption	35 VA
Communication	Bus: BACnet / IP Room unit: PPS2
Universal inputs/outputs, number	24
Digital inputs, number	4
Digital outputs, number	8
Dimensions (W x H x D)	293 x 176 x 77 mm

Stock No.

Product No.

BPZ:PXC36-E.D

PXC36-E.D

Automation controls

Automation stations

Modular series PXC..D

PXC50..D/PXC100..D/ PXC200..D



Automation stations, modular series PXC..D

The freely programmable modular series PXC..D automation stations with its free I/O configuration and DIN compliant construction are optimized for panel assembly. It primarily controls and monitors larger items of plant. The flexible TX-I/O modul product range for signaling, measuring, metering, switching and positioning can be seamlessly connect to the automation station.

- Management functions (alarm management, time schedules, trend functions, remote management, access protection etc.)
- Standalone application or for use in the device or system network
- PXX-L11/12 for connecting RXC room controllers / LonWorks devices
- Connection of the PXM.. operator unit
- BTL tested BACnet communication on LonTalk, PTP or IP according to BACnet standard (rev 1.12 - as of Desigo V6.0) incl. B-BC profile
- AMEV profiles AS-A and AS-B according to guide line "BACnet 2011 - Version 1.2 (as of Desigo V6.0)"

Data sheet	N9222
Operating voltage	AC 24 V
Frequency	50/60 Hz
Degree of protection	IP20
Memory	Flash: 32 MB SDRAM: 64 MB
Rate of transmission	LON-bus: 78 kbps Ethernet / IP: 10/100 MBit/s
Battery life	4 years
Dimensions (W x H x D)	192 x 74 x 96 mm

Range overview PXC50..D/PXC100..D/PXC200..D

Product Title	Communication	Data sheet	Stock No.	Product No.
Automation station BACnet/Lon-Talk, with up to 52 data points	Bus: BACnet / LonTalk	N9222	S55372-C109	PXC50.D
Automation station BACnet/IP, with up to 52 data points	Bus: BACnet / IP	N9222	S55372-C110	PXC50-E.D
Automation station BACnet/Lon-Talk, with up to 200 data points	Bus: BACnet / LonTalk	N9222	BPZ:PXC100.D	PXC100.D
Automation station BACnet/IP, with up to 200 data points	Bus: BACnet / IP	N9222	BPZ:PXC100-E.D	PXC100-E.D
Automation station BACnet/Lon-Talk, with more than 200 data points	Bus: BACnet / LonTalk	N9222	BPZ:PXC200.D	PXC200.D
Automation station BACnet/IP, with more than 200 data points	Bus: BACnet / IP	N9222	BPZ:PXC200-E.D	PXC200-E.D

Option modules PXA40..

PXA40-T



Option module with remote management via modem for automation stations

Option module for usage with modular automation stations PXC..D.

Data sheet	N9222		
Communication	Modem		
Degree of protection	IP20		
		Stock No.	Product No.
		BPZ:PXA40-T	PXA40-T

Option modules with web functions (PX Web) for modular automation stations PXC..-E.D

PXA40-W..



Option modules for modular automation stations PXC..-E.D.

Data sheet N9222

Range overview PXA40-W..

Product Title	Stock No.	Product No.
Option module with Web function (generic/graphic) for one automation station	BPZ:PXA40-W0	PXA40-W0
Option module with Web function (generic) for all automation stations in the BACnet net-work	BPZ:PXA40-W1	PXA40-W1
Option module with Web function (generic/graphic) for all automation stations in the BAC-net network	BPZ:PXA40-W2	PXA40-W2

Extension module for Integration of existing PTM I/O modules

PXX-PBUS

The PXX-PBUS extension module allows for integrating existing PTM I/O modules in Desigo.

The PXX-PBUS extension module, when combined with a modular series PXC..D automation station and one or two TXS1.12F12 supply modules, replaces the UNIGYR and VISONIK process units as well as the PXC64-U, PXC128-U automation stations.

- PTM I/O modules can continue to be used.
- Existing periphery can be assumed without a change.
- Control panel wiring can be assumed and need only be supplemented by new supply modules.



Data sheet N9283

	Stock No.	Product No.
	S55842-Z107	PXX-PBUS

PXX-L11/12 for connecting RXC room controllers / LonWorks devices

Product Title	Data sheet	Stock No.	Product No.
Extension module for up to 60 LonWorks devices / RXC room controllers	N9282	BPZ:PXX-L11	PXX-L11
Extension module for system controllers LonWorks PXC00.D/PXC00-E.D as well as modular automation stations PXC..D/PXC..-E.D. When combined with PXC100/200..D the number of devices / controllers is reduced in relation to performance. For PXC50..D 10 devices / controllers are permissible.			
Extension module for up to 120 LonWorks devices / RXC room controllers	N9282	BPZ:PXX-L12	PXX-L12
for system controller LonWorks PXC00.D/PXC00-E.D as well as modular automation stations PXC..D/PXC..-E.D. When combined with PXC100/200..D the number of devices / controllers is reduced in relation to performance. For PXC50..D 10 devices / controllers are permissible.			

Automation controls

Automation stations

PX System controller

PXC001..D



System controllers for the integration of third-party devices and systems in Design

Integration platforms and system controllers for third-party devices and systems via KNX, Modbus, M-Bus and other protocols into the automation level via BACnet

- System controllers for the integration of Desigo RXB/RXL room controllers
- Native BACnet devices with communication via BACnet/LonTalk or BACnet/IP
- BTL label (BACnet communications passed the BTL test)
- Comprehensive management and system functions (alarm management, time scheduling, trends, remote management, access protection etc.)
- Supports operation via local or network-compatible operator units PXM..

Data sheet	N9223
Operating voltage	AC 24 V
Frequency	50/60 Hz
Degree of protection	IP20
Memory	Flash: 32 MB SDRAM: 64 MB
Rate of transmission	LON-bus: 78 kbps Ethernet / IP: 10/100 MBit/s
Battery life	10 years
Dimensions (W x H x D)	272 x 70 x 134 mm

Range overview PXC001..D/ PXC00..D

Product Title	Communication	Data sheet	Stock No.	Product No.
System controller for the integration of KNX, M-Bus, Modbus or SCL over BACnet/LonTalk	Bus: BACnet / LonTalk	N9223	S55372-C113	PXC001.D
System controller for the integration of KNX, M-Bus, Modbus or SCL over BACnet/IP	Bus: BACnet / IP	N9223	S55372-C114	PXC001-E.D
System controller BACnet/Lon-Talk	Bus: BACnet / LonTalk	N9222	BPZ:PXC00.D	PXC00.D
System controller BACnet/IP	Bus: BACnet / IP	N9222	BPZ:PXC00-E.D	PXC00-E.D

Hardware for PXC00..D

Product Title	Data sheet	Stock No.	Product No.
Extension module for up to 60 LonWorks devices / RXC room controllers	N9282	BPZ:PXX-L11	PXX-L11
Extension module for system controllers LonWorks PXC00.D/PXC00-E.D as well as modular automation stations PXC..D/PXC..-E.D. When combined with PXC100/200..D the number of devices / controllers is reduced in relation to performance. For PXC50..D 10 devices / controllers are permissible.			
Extension module for up to 120 LonWorks devices / RXC room controllers	N9282	BPZ:PXX-L12	PXX-L12
for system controller LonWorks PXC00.D/PXC00-E.D as well as modular automation stations PXC..D/PXC..-E.D. When combined with PXC100/200..D the number of devices / controllers is reduced in relation to performance. For PXC50..D 10 devices / controllers are permissible.			

Option modules PXA40-W..

Product Title	Data sheet	Stock No.	Product No.
Option modules with web functions (PX Web) for modular automation stations PXC...E.D	N9222	BPZ:PXA40-W..	PXA40-W..



Automation controls

Automation stations

Desigo™ PX Open

PX KNX

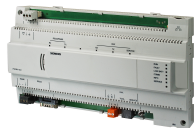

PX KNX system controller

Integration of room controllers from the Desigo RXB and Desigo RXL product range and from KNX third-party systems into the Desigo building automation and control system (interface functionality). Further functions: Grouping of rooms and performance of higher level system functions.

- BTL tested BACnet communication on LonTalk or IP according to BACnet standard (rev 1.12 - as of Desigo V6.0) include B-BC profile
- AMEV profiles AS-A and AS-B according to guide line 'BACnet 2011 - Version 1.2 (as of Desigo V6.0)'

Functions

KNX data points are mapped to BACnet data points and vice versa. The PX KNX system controller performs the following major tasks:

- Compression of Desigo RXB/RXL room controller data and other KNX data points (e.g. room thermostats RDG/ RDF/ RDU) at the automation level
- Mapping of Desigo RXB/RXL and other KNX applications to BACnet for monitoring and operation purposes (grouped according to function:HVAC, lighting and blinds)
- Performance of higher level functions for room automation: Room and supply-related groups, system functions such as changeover, summer/winter compensation, etc.

The RXB/RXL and KNX applications are mapped to the PX KNX system controller so that a room view is created. This allows for the grouping of rooms, e.g. for shared occupancy schedules, lighting or blind commands, etc

	Stock No.	Product No.
	BPZ:PX KNX	PX KNX

Hardware for PX KNX

Product Title	Communication	Data sheet	Stock No.	Product No.
System controller for the integration of KNX, M-Bus, Modbus or SCL over BACnet/LonTalk	Bus: BACnet / LonTalk	N9223	S55372-C113	PXC001.D
System controller for the integration of KNX, M-Bus, Modbus or SCL over BACnet/IP	Bus: BACnet / IP	N9223	S55372-C114	PXC001-E.D

PX M-Bus



PX M-bus system controller

M-bus datapoints are mapped to BACnet datapoints and vice-versa. The PX M-bus system controller performs the following major tasks.

- BTL tested BACnet communication on LonTalk or IP according to BACnet standard (rev 1.12 - as of Desigo V6.0) include B-BC profile
- AMEV profiles AS-A and AS-B according to guide line 'BACnet 2011 - Version 1.2 (as of Desigo V6.0)'

Functions

- Acquisition of consumption data and remote monitoring of max. 250 consumption meters and heat meters
- Compression of consumption and heat meter data volume at the automation level
- Mapping of M-bus data to BACnet
- Trend objects for meter monitoring.

	Stock No.	Product No.
	BPZ:PX M-Bus	PX M-Bus

Hardware for M-bus

Product Title	Communication	Data sheet	Stock No.	Product No.
System controller for the integration of KNX, M-Bus, Modbus or SCL over BACnet/LonTalk	Bus: BACnet / LonTalk	N9223	S55372-C113	PXC001.D
System controller for the integration of KNX, M-Bus, Modbus or SCL over BACnet/IP	Bus: BACnet / IP	N9223	S55372-C114	PXC001-E.D
Option module for integration up to 800 data points (SCL, M-bus, Modbus)	M-bus Modbus SCL	N9223	S55372-C115	PXA40-RS1
Option module for integration up to 1000 (SCL) or 2000 (M-bus, Modbus) data points	M-bus Modbus SCL	N9223	S55372-C116	PXA40-RS2

PX Modbus system controller

The PX Modbus provides a platform for the integration of various third-party systems and devices. It allows for the exchange of information with the Desigo building automation and control system at the automation level.

- BTL tested BACnet communication on LonTalk or IP according to BACnet standard (rev 1.12 - as of Desigo V6.0) include B-BC profile
- AMEV profiles AS-A and AS-B according to guide line 'BACnet 2011 - Version 1.2 (as of Desigo V6.0)'

Functions

PX Modbus supports the following Modbus function codes and data formats:

- Function codes: 01, 02, 03, 04, 05, 06, 15, 16.
- Data formats:
 - 16-bit signed and unsigned integers
 - 32-bit signed and unsigned integers
 - 32-bit signed and unsigned 'Modulus-10000'
 - Real 32-bit (IEEE floating point)
 - ACM 16-bit
 - BCD 16-bit and 32-bit

Master or slave

- The PX Modbus can be configured as either a master or slave. It supports up to 2000 third-party system data points

PX Modbus



Stock No.	Product No.
BPZ:PX Modbus	PX Modbus

NEW PRODUCT

Automation controls

Automation stations

Desigo™ PX Open

Hardware for PX Modbus

Product Title	Communication	Data sheet	Stock No.	Product No.
System controller for the integration of KNX, M-Bus, Modbus or SCL over BACnet/LonTalk	Bus: BACnet / LonTalk	N9223	S55372-C113	PXC001.D
System controller for the integration of KNX, M-Bus, Modbus or SCL over BACnet/IP	Bus: BACnet / IP	N9223	S55372-C114	PXC001-E.D
Option module for integration up to 800 data points (SCL, M-bus, Modbus)	M-bus Modbus SCL	N9223	S55372-C115	PXA40-RS1
Option module for integration up to 1000 (SCL) or 2000 (M-bus, Modbus) data points	M-bus Modbus SCL	N9223	S55372-C116	PXA40-RS2

PXA40-RS..



Option modules for integration of M-bus, Modbus, SCL

Option module for usage with system controller PXC001..D.

Data sheet	N9223
Communication	M-bus Modbus SCL
Degree of protection	IP20

Range overview PXA40-RS..

Product Title	Stock No.	Product No.
Option module for integration up to 800 data points (SCL, M-bus, Modbus)	S55372-C115	PXA40-RS1
Option module for integration up to 1000 (SCL) or 2000 (M-bus, Modbus) data points	S55372-C116	PXA40-RS2

PXG3..



3

BACnet router

The PXG3.. BACnet router connects a BACnet Ethernet/IP network (BACnet/IPv4 and BACnet/IPv6) to a BACnet/LonTalk network (PXG3.L only), and/or a BACnet/MS/TP channel. BACnet objects are simultaneously transmitted among any and all networks.

- Routing between BACnet MS/TP, BACnet/LonTalk (PXG3.L only), and BACnet/IP
- Routing between BACnet/IPv4 and BACnet/IPv6
- Configuration with Desigo Xwork Plus
- LED indication
- 2-port Ethernet switch for low-cost cabling (10/100 baseT)
- BACnet MS/TP (RS-485) baud rates: 9600, 19200, 38400, 76800
- BTL tested BACnet communication according to BACnet standard (rev 1.12 - as of Desigo V6.0)

Data sheet N9270

Operating voltage AC 24 V

DC 24 V

Frequency 50/60 Hz

Degree of protection IP20

Range overview PXG3..

Product Title	Communication	Dimensions (W x H x D)	Stock No.	Product No.
BACnet router, BACnet Ethernet/IP to BACnet/LonTalk or BACnet/MS/TP	BACnet / IP (BACnet/IPv4 and BACnet/IPv6) BACnet / LonTalk BACnet / MS / TP	162 x 74 x 90 mm	S55842-Z105-A100	PXG3.L
BACnet router, BACnet Ethernet/IP to BACnet/MS/TP	BACnet / IP (BACnet/IPv4 and BACnet/IPv6) BACnet / MS / TP	162 x 74 x 90 mm	S55842-Z106-A101	PXG3.M

Accessories for PXG3..

Product Title	Data sheet	Stock No.	Product No.
Bus terminator 52.3 Ohm for LonWorks bus	N3861	BPZ:RXZ01.1	RXZ01.1
Bus terminator 105 Ohm for LonWorks bus	N3861	BPZ:RXZ02.1	RXZ02.1
Connecting cable RJ45 - RHJ45, cable length 3 m	N9234	BPZ:PXA-C1	PXA-C1
Adapter RJ45 - RS232 at computer	N9234	BPZ:PXA-C2	PXA-C2

Automation controls

Automation stations

Integral migration PXC-NRU..

PXC-NRUF



Automation station for Integral migration, integrates 64 data points in Desigo

In existing Integral plants, you can replace compact automation units NRUE/A, NRUF/A and NRUT/A with the PXC NRUF automation station.

Fixed data point mix for 64 physical data points per automation station UI=16, DI=24, DO=16, UO=8.

- BTL tested BACnet communication on LonTalk or PTP according to BACnet standard (rev 1.12 - as of Desigo V6.0) include B-BC profile
- AMEV profiles AS-A and AS-B according to guide line 'BACnet 2011 - Version 1.2 (as of Desigo V6.0)'

Data sheet	N9760
Operating voltage	AC 24 V
Frequency	50/60 Hz
Power consumption	26 VA
Communication	Bus: BACnet / LonTalk Bus: BACnet / PTP (point to point) Room unit: PPS2
Dimensions (W x H x D)	265 x 295 x 100 mm
Universal inputs, number	16
Universal outputs, number	8
Digital inputs, number	24
Digital outputs, number	16

Stock No. Product No.

BPZ:PXC-NRUF PXC-NRUF

PXC-NRUD



Adapter plug-in circuit board for Integral NK modules, integrates 48 data points in Desigo

This adapter, combined with an automation station PXC100..D, serves as a replacement for the modular automation stations NRUA/A, NRUB/A, NRUC/A and NRUD/A.

Fixed data point mix for 48 physical data points per adapter DI=8, DO=8, UI/UO=32.

The adapter consists of a plug-in circuit board with front plate.

It is inserted into an existing card housing NHGB.

Data sheet	N9761
Operating voltage	AC 24 V
Frequency	50/60 Hz
Power consumption	18 VA
Communication	Bus: TX-I/O island bus to TXB1.PBUS
Universal inputs, number	16
Universal outputs, number	16
Digital inputs, number	8
Digital outputs, number	8

Stock No. Product No.

BPZ:PXC-NRUD PXC-NRUD

PMX50



15.6-inch touch panel

The Desigo PXM50 touch panel of Desigo Touch and Web is designed for control panel mounting. It is used together with the web interface PXG3.W100 and adapts the standard technology used for the web interface for local operation of the technical installations in the building. The touch panel allows for intuitive and efficient operation of multiple Desigo PXC..D/U automations stations (version 4 or higher) and allows for permanent monitoring of technical installations in a building. TCP/IP is used for communications.

- Compact design with low built-in depth, for mounting in control panel doors
- High-resolution TFT display with 16.7 million colors. Resolution: 1366 x 768 pixels (wide screen)
- Capacitive touch screen
- Dimmable LED background lighting
- Intuitive operation and monitoring of multiple plants or Desigo PX automation stations
- Optimized for local operation of the Desigo building automation and control system
- LED to indicate alarms while the screen is off
- Connection via Ethernet RJ45
- Commissioning wizard
- Remote access via VNC to the touch panel
- No additional mounting materials required

Data sheet	N9293
Operating voltage	AC 24 V DC 24 V
Frequency	50/60 Hz
Power consumption	13 W 26 VA
Display size	396.7 mm (15.6 "), resolution: 1366 x 768 pixels
Interface type	Ethernet IP
Mounting	In control panel doors In operating tablets
Degree of protection	IP54 / IP20
Ambient temperature, operation	0...50 °C
Dimensions (W x H x D)	419 x 270 x 51.3 mm

Stock No.	Product No.
S55623-H120	PMX50

PXM40



10.1-inch touch panel

The Desigo PXM40 touch panel of Desigo Touch and Web is designed for control panel mounting. It is used together with the web interface PXG3.W100 and adapts the standard technology used for the web interface for local operation of the technical installations in the building. The touch panel allows for intuitive and efficient operation of multiple Desigo PXC..D/U automations stations (version 4 or higher) and allows for permanent monitoring of technical installations in a building. TCP/IP is used for communications.

- Compact design with low built-in depth, for mounting in control panel doors
- High-resolution TFT display with 262 k colors. Resolution: 1280 x 800 pixels (wide screen)
- Capacitive touch screen
- Dimmable LED background lighting
- Intuitive operation and monitoring of multiple plants or Desigo PX automation stations
- Optimized for local operation of the Desigo building automation and control system
- LED to indicate alarms while the screen is off
- Connection via Ethernet RJ45
- Commissioning wizard
- Remote access via VNC to the touch panel
- No additional mounting materials required

Data sheet	N9292
Operating voltage	AC 24 V DC 24 V
Frequency	50/60 Hz
Power consumption	7 W 14 VA
Display size	256.4 mm (10.1 "), resolution: 1280 x 800 pixels
Interface type	Ethernet IP
Mounting	In control panel doors In operating tablets
Degree of protection	IP54 / IP20
Ambient temperature, operation	0...50 °C
Dimensions (W x H x D)	289 x 198 x 51.3 mm

Stock No.

Product No.

S55623-H119

PXM40

Accessories for PXM..

Product Title	Data sheet	Stock No.	Product No.
Multifunction cover blade for panel door or wall mount		BPZ:PXA-H1	PXA-H1
Connecting cable RJ45 - RHJ45, cable length 3 m	N9234	BPZ:PXA-C1	PXA-C1
Adapter RJ45 - RS232 at computer	N9234	BPZ:PXA-C2	PXA-C2
Adapter from PXM20.. for firmware download	N9234	S55372-C108	PXA-C4

PXG3.W100



3

Web interface BACnet/IP for Desigo Touchpanels

The PXG3.W100 web interface serves as the central access point to operate the automation level. A central access point also allows for concurrent operation of different operator units while supporting connection of the Desigo touch panels PXM40 / PXM50 as well as providing access using devices featuring a standard web browser (HTML5 technology) on various hardware platforms. (e.g. tablets, notebook/PC, smartphones).

- Connection via Ethernet
- Central user interface for simultaneous access from various operator units
- Offline engineering using Xworks Plus
- Upload/download of configuration data via LAN, or Internet
- LED indication for Ethernet link and activity
- 2-port Ethernet switch for low-cost cabling (10/100baseT)

Data sheet	N9294
Operating voltage	AC 24 V DC 24 V
Frequency	50/60 Hz
Degree of protection	IP20
Dimensions (W x H x D)	162 x 109 x 77.5 mm

Stock No.	Product No.
-----------	-------------

S55842-Z115	PXG3.W100
-------------	-----------

Accessories for PXG3.W100

Product Title	Data sheet	Stock No.	Product No.
Connecting cable RJ45 - RJ45, cable length 3 m	N9234	BPZ:PXA-C1	PXA-C1
Adapter RJ45 - RS232 at computer	N9234	BPZ:PXA-C2	PXA-C2

PXM20



Operator unit with BACnet on LonTalk

The network-capable PXM20 operator unit allows for homogenous operation of a multitude of building services plants at the automation level. The operator unit offers an operating keyboard and a high-resolution display for graphics and text. The PXM20 can be used on-site or remote for all plants connected via a network. The operator unit can be integrated in a panel or plugged into a modular automation station of the PXC...U series.

Operating functions

Transparently organized function and quick-access keys allow even casual users to expertly operate the unit. The operator unit offers the following operator functions (among others):

- Easy-to-understand user instructions via the plant function
- Full access to all actual values, setpoints, plant and operating states, and parameters
- Complete data point operation and setpoint entry via clear text
- Optical and acoustic alarm indication.
- Alarm management with acknowledgement function and alarm memory
- Graphical display for scheduler program, exception day calendar, online trend heating curve
- Summary of all important values via Favorites
- Support of multi-level access protection

Data sheet	N9231
Operating voltage	AC 24 V DC 12...40 V
Frequency	50/60 Hz
Power consumption	4 W 9 VA
Display size	Display area: 123 x 68 mm No. of dots: 240 x 128 dots
Interface type	LON-bus RS 232-interface
Mounting	In panel On automation station PXC...U On DIN rail
Degree of protection	IP40
Ambient temperature, operation	0...50 °C
Dimensions (W x H x D)	210 x 117 x 37 mm
Keyboard	Keypad with plastic membrane and pressure point

	Stock No.	Product No.
	BPZ:PXM20	PXM20

PXM20-E



Operator unit with BACnet on IP

Provides the same functionality as PXM20, but with BACnet/IP communication.

Data sheet	N9234
------------	-------

	Stock No.	Product No.
	BPZ:PXM20-E	PXM20-E



Operator unit, local

The PXM10 operator unit allows for operating and monitoring a Desigo PX automation station. The unit offers user-friendly single-button operation via a turn/press button and a high-quality display. The operator unit can be integrated in a panel or a modular automation station of the PXC...-U series.

Operating functions

- Display for setpoints and actual values, plant and operating states
- Setpoint adjustment
- Optical fault indication
- Alarm display with acknowledgement function
- Graphical display of scheduler programs

Data sheet	N9230
Operating voltage	AC 24 V DC 12...40 V
Power consumption	0.7 W 1 VA
Display size	Display area: 82 x 42 mm No. of dots: 128 x 64 dots
Interface type	RS 232-interface
Cable length	3 m
Degree of protection	IP40
Ambient temperature, operation	0...50 °C
Dimensions (W x H x D)	210 x 117 x 37 mm
Weight (incl. packaging)	0.350 kg

Stock No.	Product No.
BPZ:PXM10	PXM10

Accessories for PXM..

Product Title	Data sheet	Stock No.	Product No.
Multifunction cover blade for panel door or wall mount		BPZ:PXA-H1	PXA-H1
Connecting cable RJ45 - RJ45, cable length 3 m	N9234	BPZ:PXA-C1	PXA-C1
Adapter RJ45 - RS232 at computer	N9234	BPZ:PXA-C2	PXA-C2
Adapter from PXM20.. for firmware download	N9234	S55372-C108	PXA-C4

TXM1..

TX-I/O™ modules

Simple planning and executions:

- Slim, easy-to-understand I/O product range
- Highest flexibility for I/O point mix

Efficient panel construction:

- Small space requirements thanks to very compact construction
- DIN form eases panel construction using standard components
- Self-learning bus connections of the TX-I/O™ module with power supply
- Direct connection with interchange pins

Fast commissioning and service:

- Easiest possible addressing
- Fast servicing: plug-in I/O module exchange without tools or rewiring
- permute proof terminal bases

Operating voltage	DC 22.5...26 V
Dimensions (W x H x D)	64 x 77.5 x 98 mm

Easy-to-understand operation:

- Local priority operation as per VDI3814
- Simple display concept with LCD and colored LEDs

TXM1.8D



8 Digital Input Module

8 digital input, signaling per input with three-colored LED (green, yellow, red), without local operation.

8 DI, individually configurable as:

- Message signal
- Message impulse with storage functions
- Counter impulse for up to a maximum of 10 Hertz

Data sheet	N8172
Operating voltage	DC 22.5...26 V
Power consumption	1.1 W
Dimensions (W x H x D)	64 x 77.5 x 98 mm
Weight	0.164 kg

Stock No.	Product No.
BPZ:TXM1.8D	TXM1.8D

TXM1.16D



16 Digital Input Module

16 digital input, signaling per input with green LED, without local operation.

16 DI, individually configurable as:

- Message signal
- Message impulse with storage functions
- 8 inputs as counter impulse for up to a maximum of 10 Hertz

Data sheet	N8172
Operating voltage	DC 22.5...26 V
Power consumption	1.4 W
Dimensions (W x H x D)	64 x 77.5 x 98 mm
Weight	0.199 kg

Stock No.	Product No.
BPZ:TXM1.16D	TXM1.16D

6 Relay output module, bistable

TXM1.6RL



6 outputs signaled with green LED, without local operation.

6 DO (volt-free, bistable), individually configurable as:

- Switching of fluorescent lamps (number of ballasts see data sheet)
- Configurable behavior in case of power failure and bus failure
- Max. inrush current 800 A (20 μ s), 165 A (20 ms)
- Switching voltage AC 24...277 V
- Switching current max. 10 A ($\cos \varphi = 0.8$)

Data sheet	N8177
Operating voltage	DC 22.5...26 V
Power consumption	0.8 W
Dimensions (W x H x D)	64 x 77.5 x 98 mm
Weight	0.27 kg

Stock No. Product No.

S55661-J103 **TXM1.6RL**

6 Relay output module

TXM1.6R



6 outputs signaled with green LED, without local operation.

6 DO (relay switch), individually configurable as:

- Continuous or impulse contact
- Single-stage or multi-stage
- Three-point positioning output with internal stroke model
- Switching voltage AC 12...250 V / DC 12...30 V
- Switching current max. 4 A

Hardware bolting device is by means of external wiring the two-way contacts.

Data sheet	N8175
Operating voltage	DC 22.5...26 V
Power consumption	1.7 W
Dimensions (W x H x D)	64 x 77.5 x 98 mm
Weight	0.231 kg

Stock No. Product No.

BPZ:TXM1.6R **TXM1.6R**

TXM1.6R-M

**6 Relay output module with Override**

6 outputs, signaling per output with three-colored LED (green, yellow, red), with local operation as per ISO 16484.

6 DO (relay switch), individually configurable as:

- Continuous or impulse contact
- Single-stage or multi-stage
- Three-point positioning output with internal stroke model
- Switching voltage AC 12...250 V / DC 12...30 V
- Switching current max. 4 A

Hardware bolting device is by means of external wiring the two-way contacts.

Data sheet	N8175
Operating voltage	DC 22.5...26 V
Power consumption	1.9 W
Dimensions (W x H x D)	64 x 77.5 x 98 mm
Weight	0.241 kg

Stock No.	Product No.
-----------	-------------

BPZ:TXM1.6R-M	TXM1.6R-M
---------------	------------------

TXM1.8P

**8 Resistance measuring input module**

8 inputs with LED signal / fault display.

8 resistance measuring inputs with individual configuration of resistance or temperature measurement:

- Pt100 (4-wire)
- Pt1000, Ni1000
- Resistance 250 ohm or 2500 ohm (2-wire)

Data sheet	N8176
Operating voltage	DC 22.5...26 V
Power consumption	1.2 W
Dimensions (W x H x D)	64 x 77.5 x 98 mm
Weight	0.219 kg

Stock No.	Product No.
-----------	-------------

BPZ:TXM1.8P	TXM1.8P
-------------	----------------

8 Triac output module

TXM1.8T



8 Triac outputs, signaled with green LED.

8 AO, configurable for:

- Permanent contact
- Three-point positioning output with internal stroke model
- Pulsewidth-modulated output (PWM)
- Switching voltage AC 24 V
- Switching current AO 3-position: 250 mA / 6 VA per output
- Switching current AO PWM, BO: 125 mA / 3 VA per output

Data sheet	N8179
Operating voltage	DC 22.5...26 V
Power consumption	1.0 W
Dimensions (W x H x D)	64 x 77.5 x 98 mm
Weight	0.198 kg

Stock No.	Product No.
S55661-J106	TXM1.8T

8 Universal I/O Module

TXM1.8U



8 inputs/outputs signaled with green LED, without local operation

8 universal I/O points, individually configurable as:

- DI: Message signal, message impulse or counter impulse (25 Hertz)
- AI: Temperature sensor or DC 0...10 V
- AO: DC 0...10 V

Data sheet	N8173
Operating voltage	DC 22.5...26 V
Power consumption	1.5 W
Dimensions (W x H x D)	64 x 77.5 x 98 mm
Weight	0.179 kg

Stock No.	Product No.
BPZ:TXM1.8U	TXM1.8U

8 Universal I/O Module, Override and LCD

TXM1.8U-ML



8 inputs/outputs signaled with green LED, with local operation as per ISO 16484 with LCD signal display.

8 universal I/O points, individually configurable as:

- DI: Message signal, message impulse or counter impulse (25 Hertz)
- AI: Temperature sensor or DC 0...10 V
- AO: DC 0...10 V

Data sheet	N8173
Operating voltage	DC 22.5...26 V
Power consumption	1.8 W
Dimensions (W x H x D)	64 x 77.5 x 98 mm
Weight	0.202 kg

Stock No.	Product No.
BPZ:TXM1.8U-ML	TXM1.8U-ML

**Desigo TX-I/O
I/O modules TXM..**

3

TXM1.8X



8 Universal I/O Module, 4-20mA,

8 Inputs/outputs signaled with green LED, without local operation (same functionality as TXM1.8U, but with current input/output).

8 universal I/O points, individually configurable as:

- DI: Message signal, message impulse (with storage function) or counter impulse (25 Hz)
- AI: Temperature sensor, DC 0...10 V, or 4...20 mA
- AO: DC 0...10 V, 4...20 mA (for 4 I/O points)

Data sheet	N8174
Operating voltage	DC 22.5...26 V
Power consumption	2.2 W
Dimensions (W x H x D)	64 x 77.5 x 98 mm
Weight	0.194 kg

Stock No.	Product No.
BPZ:TXM1.8X	TXM1.8X

TXM1.8X-ML



8 Universal I/O Module, 4-20mA, Override and LCD

8 Inputs/outputs signaled with green LED, with local operation as per ISO 16484 with LCD signal display (same functionality as TXM1.8U-ML, but with current input/output).

8 universal I/O points, individually configurable as:

- DI: Message signal, message impulse (with storage function) or counter impulse (25 Hertz)
- AI: Temperature sensor, DC 0...10 V, or 4...20 mA
- AO: DC 0...10 V, 4...20 mA (for 4 I/O points)

Data sheet	N8174
Operating voltage	DC 22.5...26 V
Power consumption	2.3 W
Dimensions (W x H x D)	64 x 77.5 x 98 mm
Weight	0.211 kg

Stock No.	Product No.
BPZ:TXM1.8X-ML	TXM1.8X-ML

TX Open RS232/485 module for integrating third-party systems and devices to Desigo

TXI1.OPEN



3

RS232/485 module as platform to integrate third-party systems and devices to the Desigo building automation and control system via modular automation stations PXC..D (Version 4 or higher).

- With LED's to monitor operating and communication status
- USB interface for connecting the TX Open Tool
- Easy installation and setup
- Simple, fast diagnostics
- Suitable for operation using pre-defined applications for the following systems:
 - Modbus
 - M-Bus
 - G120P
 - Grundfos- and Wilo pumps

Data sheet	N8185
Operating voltage	DC 24 V
Power consumption	1.32 W
Communication	RS232 RS485
Dimensions (W x H x D)	96 x 77.5 x 98 mm
Weight	0.168 kg

Stock No.

Product No.

S55661-J100

TXI1.OPEN

TXA1.IBE

**Island bus expansion module for decentralized sub-islands with TX-I/O-modules**

- Expand island bus to a distance of up to 2 x 200 meters
- Compact design per DIN 43 880, requires little space
- With LED to monitor communication status
- Easy installation and setup:
 - Mounted on standard rails
 - Self-connecting bus (island bus) for the easiest possible installation
 - Plug-in screw terminals for island bus expansion
 - No programming / parameterization tool required

Data sheet N8184

Dimensions (W x H x D) 32 x 77.5 x 98 mm

Weight 0.064 kg

Stock No.

Product No.

BPZ:TXA1.IBE

TXA1.IBE

TXS1.12F10

**TX-I/O Power Supply Modules 24 VDC Supply 1200 mA, 10 A Fuse**

Up to 4 power supply modules can be operated in parallel
 AC 24 Volt input
 Generation / transfer of DC 24 V, 1.2A for the supply of TX-I/O modules and field devices
 Fresh provision of AC 24 V for field device supply
 Transfer of the bus signal

Data sheet N8183

Dimensions (W x H x D) 96 x 77.5 x 98 mm

Weight 0.309 kg

Stock No.

Product No.

BPZ:TXS1.12F10

TXS1.12F10

TXS1.EF10

**BUS Connection Module, 10A Fuse**

Transfer of DC 24 V for the supply of TX-I/O modules and field devices
 Fresh provision of AC / DC 12 ... 24 V for field device supply
 Transfer of the bus signal

Data sheet N8183

Dimensions (W x H x D) 32 x 77.5 x 98 mm

Weight 0.082 kg

Stock No.

Product No.

BPZ:TXS1.EF10

TXS1.EF10

P-bus interface module

TXB1.PBUS

- Interface between the automation station PXC64-U/PXC128-U and the bus of the TX-I/O modules
- Integrated DC 24 V, 1.2 A to supply power to TX-I/O modules and field devices
- USB port for tool connection



Data sheet	N8180
Dimensions (W x H x D)	128 x 77.5 x 98 mm
Weight	0.28 kg

	Stock No.	Product No.
	BPZ:TXB1.PBUS	TXB1.PBUS

Set of address plugs

Product Title	Data sheet	Stock No.	Product No.
Address Keys 1-12 + reset key	N8170	BPZ:TXA1.K12	TXA1.K12
Address Keys 1-24 + 2 reset keys	N8170	BPZ:TXA1.K24	TXA1.K24
Address keys 25-48 + 2 reset keys	N8170	BPZ:TXA1.K-48	TXA1.K-48
Address keys 49-72 + 2 reset keys	N8170	BPZ:TXA1.K-72	TXA1.K-72
Address keys 73-96 + 2 reset keys	N8170	S55661-J101	TXA1.K-96
Address keys 97-120 + 2 reset keys	N8170	S55661-J102	TXA1.K-120
Address key 5, 10 ... 120 + 2 reset keys	N8170	BPZ:TXA1.5K120	TXA1.5K120

Labeling material

Product Title	Data sheet	Stock No.	Product No.
Labels (sheet A4 with 9 labels)	N8170	BPZ:TXA1.LA4	TXA1.LA4
Spare transparent label holders (10 pcs.)	N8170	BPZ:TXA1.LH	TXA1.LH

3

Room automation



Overview and selection tools

Product range overview

Comfort of building occupants and low running costs are often contradicting requirements. Room automation in Desigo system, where energy demand and production are tightly connected, can satisfy both.

Siemens offers products for scalable room automation solutions, from simple HVAC applications up to room automation with HVAC, lighting and shading, all seamlessly combined in one solution.

Desigo room automation products allow to create system with the following open standard communication protocols:

Product range	Desigo Total Room Automation (BACnet)		Desigo Room Automation (KNX)	Desigo Room Automation (Lon)
				LON
Communication (Backbone)	BACnet/IP	BACnet MS/TP	KNX	Lon
Communication with Sensors/Actuators in room (Integrations)	KNX Dali		KNX	
System integration / *System functions	PXC...E.D	PXG3.L PXC...E.D	PXC001-E.D	PXC...E.D
Modular controller I/Os	PXC3.E.. TXM			
Compact controller	DXR2.E..	DXR2.M..	RXB.. RDG.. RDF.. RDU..	RXC..
Thermostats				
Communication with room units	KNX PL-Link	KNX PL-Link	PPS2	PPS2 Lon
Room units	QMX3..	QMX3..	QAX..	QAX..
Touch screen	**QMX7..			

* Time schedules

** Connects via web server

Desigo Total Room Automation (BACnet)

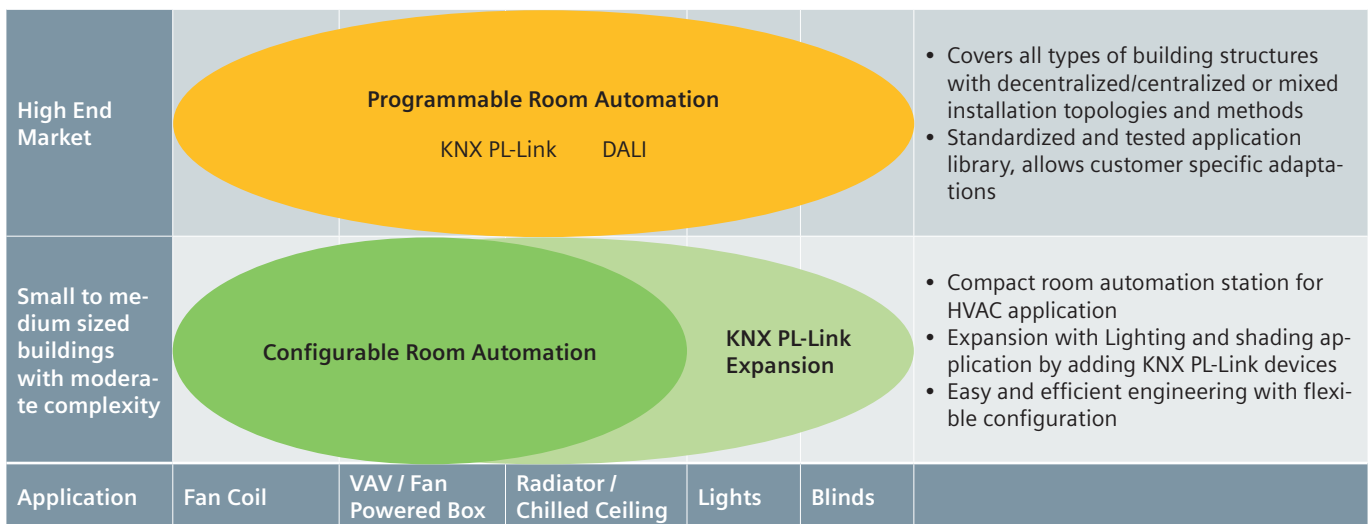

Configurable Room Automation Station with BACnet

The room automation stations DXR2.. are perfectly suited to automate heating, ventilation, and air conditioning in a room.



In addition, the DXR2.. can be extended with lighting and shading functionality by adding KNX PL- Link modules.

The room automation stations offer onboard I/O data points allowing direct connection of field devices as well as an integrated interface to KNX including power supply.

This combination allows to create data point mix that optimally matches application requirements.

DXR2.. comes with set of preloaded applications that can be flexibly configured with software tool ABT Site.

If required, DXR2.. can be also loaded with fully customized application created in software suite ABT PRO.

Topology for configurable room automation stations

BACnet/IP

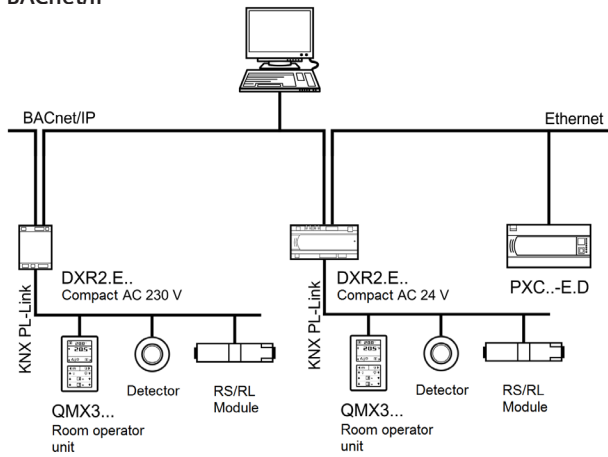

BACnet MS/TP

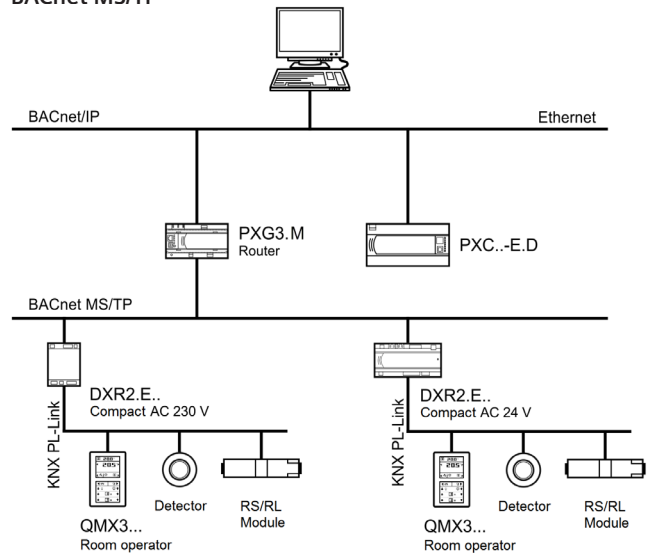

Room automation

Overview and selection tools

Configurable Room Automation Station with BACnet

Application configuration

Applications can be configured by combining functions from one or several application types:

- Room sensor and operating
- Radiant (heated/chilled) ceiling and Radiator
- Fan coil
- VAV system or Fan powered box
- Radiant (heated/chilled) ceiling and Radiator
- Lighting
- Shading

Configuration is limited by total number of data points.

Application group Central functions requires dedicated room automation station.

4

Configurable controllers



	DXR2.E09-101A	DXR2.E09T-101A	DXR2.E10-101A	DXR2.M11-101A	DXR2.E12P-102A	DXR2.E18-101A	DXR2.E18-102A
Communication							
BACnet/IP	DXR2.E09-101A	DXR2.E09T-101A	DXR2.E10-101A		DXR2.E12P-102A	DXR2.E18-101A	DXR2.E18-102A
BACnet MS/TP	DXR2.M09-101A	DXR2.M09T-101A	DXR2.M10-101A	DXR2.M11-101A	DXR2.M12P-102A	DXR2.M18-101A	DXR2.M18-102A
Application types							
Room operating	■	■	■	■	■	■	■
Heated / Chilled ceiling and Radiator	■	■	■	■	■	■	■
Fan coil	■	■	■	■		■	
VAV system or Fan powered box					■		■
Lighting	■	■	■	■	■	■	■
Shading	■	■	■	■	■	■	■
Central Functions						*■	*■
Housing							
DIN				■	■	■	■
Flat	■	■	■				
Operating voltage							
230V	■	■	■				
24V				■	■	■	■
Inputs and outputs onboard							
Digital inputs	1	1	1	1	1	2	2
Universal inputs	2	2	2	2	2	4	4
Relay outputs	3	1	3				
Triac outputs		4	4	6	6	8	8
Analog outputs (DC 0...10 V)	3	1		2	2	4	4
Pressure sensor					1		
Maximum configuration							
Total data points	30	30	30	30	30	60	60
Integrated power supply for KNX (mA)	50	50	50	50	50	50	50

* Cannot be combined with other applications

Example of product selection

1. Check application requirements

Requirements

- Fan coil
- 4-pipe system
- 3-speed fan
- 2 valves with electrothermal actuators (2-point control signal)
- Voltage AC 230 V
- Presence detector
- Room unit with built-in temperature sensor

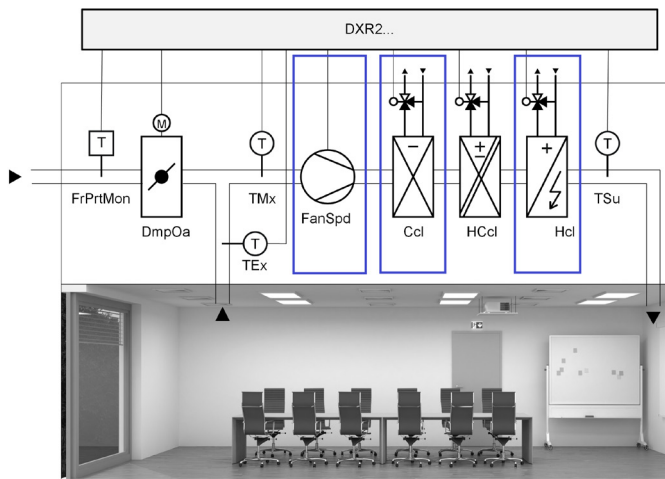

	Frost protection (FrPrtMon)	Outside air damper (DmpOa)	Extract air temperature (TEx)	Mixed air temperature (TMx)	Fan speed (FanSpd)	Cooling coil (Ccl)	Heating/cooling coil (HCcl)	Heating coil (Hcl)	Supply air temperature (TSu)
DI									
AI									
Relais					3			1	
Triac						1			
0..10 V									
Relais + 0..10 V									

2. Find matching products in overview tables

Products matching application requirements above:

Product Number	Description	Qty
DXR2.E10	Compact room automation stations, BACnet/IP, 230 V	1
QMX3.P34	Room operator unit KNX with temperature sensor, segmented backlit display, touchkeys	1
UP 258D11	Passive infrared presence detector	1
STP73	Electrothermal actuator, AC/DC 24 V, NO, 2P, 1 m	2
VMP47.10-1.6	3-port seat valve with bypass, external thread, PN16, DN10, kvs 1.6	2

Note:

Product overview tables provide quick overview and show main features, nevertheless, we recommend checking technical parameters of each product.

3. Check total data points and bus load

Used DXR2.. on-board data points: 5
 KNX PL-link data points: 5
 Total used data points: 10 < 30
 Total KNX PL-link bus load: 17.5 mA < 50 mA

Correct, total values do not exceed maximum configuration.

Room automation

Overview and selection tools

Configurable Room Automation Station with BACnet

HVAC applications

Application types

Fan coil

Application can be configured from these functions:

- Outside Air Damper
- Single Speed Fan, Multi Speed Fan or Variable Speed Fan
- Chilled water cooling coil
- Direct expansion evaporator cooling coil
- Heating/Cooling coil
- Hot water heating coil
- Electric heating coil modulating, single stage or two stage
- Room temperature control by two-pipe system with change-over
- Room temperature control by four-pipe system
- Supply air temperature cascade control
- Room dehumidification control
- Air volume flow control
- Rapid ventilation
- Green leaf

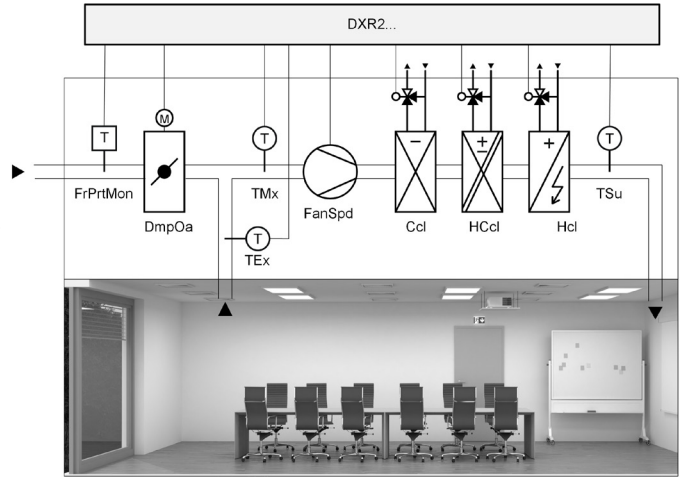

	Frost protection monitor (FrPrtMon)	Outside air damper (DmpOa)	Extract air temperature (TEx)	Mixed air temperature (TMx)	Fan speed (FanSpd)	Cooling coil (Ccl)	Heating/cooling coil (HCcl)	Heating coil (Hcl)	Supply air temperature (TSu)
DI	1								
AI			1	1					1
Relais					1-3				
Triac		2			1-2	1-2	1, 2, 4, 8	1-2	
0..10 V		1			1*	1	1, 4	1**	

* Requires additional relays or triac for enable signal

** Requires additional triac for electric heating enable signal

VAV (Variable Air Volume system)

Application can be configured from these functions:

- Supply and extract air control
- External flow control for VAV with integrated flow controller and differential pressure sensor
- Internal flow controller and differential pressure sensor for damper actuator control
- Internal flow controller and velocity sensor for damper actuator control
- Chilled water cooling coil
- Heating/Cooling coil
- Hot water heating coil
- Electric heating coil modulating, single stage or two stage
- Room temperature control by two-pipe system with change-over
- Room temperature control by four-pipe system
- Supply air temperature cascade control
- Air flow tracking for under/overpressure
- Room dehumidification control
- Room air quality control
- Rapid ventilation
- Green leaf

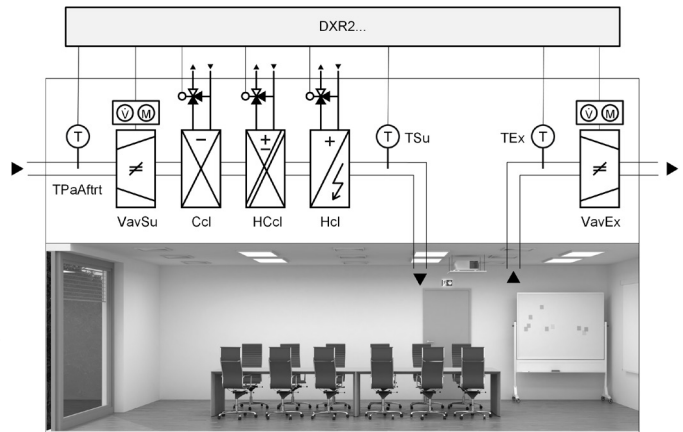

	Primary air temperature for air after-treatment (TPaAfrt)	Supply air VAV (VavSu)	Cooling coil (Ccl)	Heating/cooling coil (HCcl)	Heating coil (Hcl)	Supply air temperature (TSu)	Extract air temperature (TEx)	Extract air VAV (VavEx)
DI								
AI	1					1	1	
Relais								
Triac		2**	1-2	1, 2, 4, 8	1-2			2**
0..10 V		1	1	1, 4	1*			1
Actuator for VAV (KNX PL-Link)		1						1

* Requires additional triac for electric heating enable signal

** When using DXR2.. with AC 24 V power supply in combination with GDB181.1E/3 or GLB181.1E/3, use 0..10V signals.

4-6

Room automation Overview and selection tools Configurable Room Automation Station with BACnet

Fan powered box

Application can be configured from these functions:

- Supply air control
- External flow control for VAV with integrated flow controller and differential pressure sensor
- Internal flow controller and differential pressure sensor for damper actuator control
- Internal flow controller and velocity sensor for damper actuator control
- Single Speed Fan , 2 speed Fan or Variable Speed Fan
- Chilled water cooling coil
- Heating/Cooling coil
- Hot water heating coil
- Electric heating coil modulating, single stage or two stage
- Room temperature control by two-pipe system with change-over
- Room temperature control by four-pipe system
- Supply air temperature cascade control
- Room air quality control
- Rapid ventilation
- Green leaf

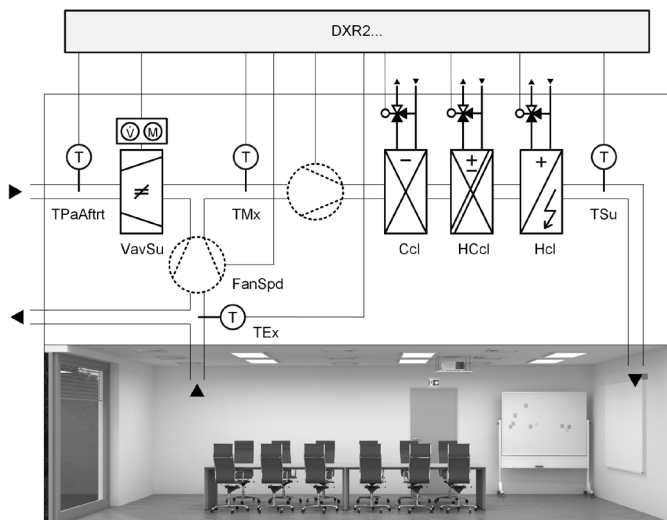

	Primary air temperature for air after-treatment (TPaftrt)	Supply air VAV (VavSu)	Extract air temperature (TEx)	Mixed air temperature (TMx)	Fan speed (FanSpd)	Cooling coil (Ccl)	Heating/cooling coil (HCcl)	Heating coil (Hcl)	Supply air temperature (TSu)
DI									
AI	1		1	1					1
Relais									
Triac		2			1-2	1-2	1, 2, 4, 8	1-2	
0..10 V		1			1*	1	1, 4	1**	
Actuator for VAV (KNX PL-Link)		1*							

* Requires additional triac for enable signal

** Requires additional triac for electric heating enable signal

Radiant ceiling and Radiator

Application can be configured from these functions:

- Chilled ceiling with chilled water
- Heated/chilled ceiling by two-pipe system with change-over
- Heated/chilled ceiling by four-pipe system with 6 way valves
- Heating ceiling with hot water
- Hot water radiator
- Electric radiator modulating or staged
- Draft compensation for radiators
- Condensation monitor
- Room temperature control
- Green leaf

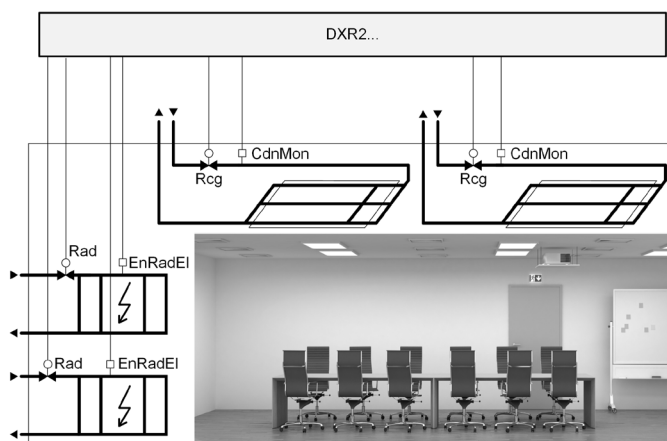

	Radiator (Rad)	Radiator overtemperature (RadOvrT)	Radiant ceiling (Rcg)	Condensation monitor (CdnMon)
DI		1		1
AI				
Relais				
Triac	1-4		1-4	
0..10 V	1-2*		1-2	

* Requires additional triac or relais for electric heating enable signal

Room automation

Overview and selection tools







Configurable Room Automation Station with BACnet

Room sensor and operating





Application can be configured from these functions:

- Room operating units QMX3 on KNX PL-Link
- Sensors for onboard IO's or KNX PL-Link
- Presence/brightness sensors for onboard IO's or KNX PL-Link
- Push buttons for light and shading on KNX PL-Link
- Window contacts for onboard IO's
- Collision detectors for onboard IO's

4

	 Temperature sensor	 Air quality Sensor	 Humidity sensor	 Brightness sensor	 Presence detector	 Collision detector
DI					2	2
AI	1	1	1			
HVAC Sensor (KNX PL-Link)	1	1	1			
Presence and brightness sensor (KNX PL-Link)				1	1-4*	
Room unit (KNX PL-Link)	1	1	1			
Combined room unit (KNX PL-Link)	1					

* Must be the same device

	 Window contact	 Room operator unit	 Light control	 Shading control	 Combined control
DI	1				
Room unit (KNX PL-Link)		2*			
Combined room unit (KNX PL-Link)		1**	1	1	1
Push button (KNX-PL-Link)			1-2****	1-2****	1***

* Must be the same device



** Can not be combined with additional push button devices (KNX PL-Link)

*** Can not be combined with additional light or blind control devices

**** Must be the same device and every light group is switched by maximum one push button or dimmed by one pair of push buttons





Room automation
Overview and selection tools
Configurable Room Automation Station with BACnet

Room units

			
	P36	QMX3.. P34	P74
Features			
Mode selection	■	■	■
Fan switch	■	■	■
Setpoint adjuster	■	■	■
Temperature sensor	■	■	■
Humidity sensor			■
Air quality sensor			■
Mounting			
Flush mounted	■		
Direct on wall		■	■
Integration into DXR2...			
Data points	3	3	5
KNX PL-Link bus load (mA)	12.5	7.5	15

4



HVAC Sensor (KNX PL-Link)

											
	AQR2570... and AQR2532NNW	AQR2570... and AQR2533NNW	AQR2570... and AQR2535NNW	AQR2570... and AQR253NNWQ	AQR2576... and AQR2530NNW	AQR2576... and AQR2532NNW	AQR2576... and AQR2533NNW	AQR2576... and AQR2535NNW	AQR2576... and AQR253NNWQ	QMX3.P30	QMX3.P70
Features											
LED indication air quality				■					■		■
Temperature sensor	■		■	■		■		■	■	■	■
Humidity sensor		■	■	■			■	■	■		■
Air quality sensor					■	■	■	■	■		■
Mounting											
Flush mounted	■	■	■	■	■	■	■	■	■		
Direct on wall										■	■
Integration into DXR2...											
Data points	1	1	2	3	1	2	2	3	3	1	3
KNX PL-Link bus load (mA)	5	5	5	5	15	15	15	15	15	7.5	15



Room automation
Overview and selection tools
Configurable Room Automation Station with BACnet

4

Presence and brightness sensor (KNX PL-link)

		
	UP 258D11	UP 258D12
Features		
Presence detector	■	■
Detection area at mounting height 2.5 m (m)	3	4.5
Brightness sensor	■	■
Integration into DXR2..		
Data points	2	2
KNX PL-link bus load (mA)	10	10

Actuator for VAV (KNX PL-Link)

		
	GDB181.1E/KN	GLB181.1E/KN
VAV compact controller		
Features		
Torque (Nm)	5	10
Air damper area (m2)	0.8	1.5
Operating range (Pa)	0...300	0...300
Operating voltage (V AC)	24	24
Integration into DXR2..		
Data points	2	2
KNX PL-link bus load (mA)	5	5

Lighting and shading



Application can be configured from these functions:

Every DXR2.. controls up to 4 lighting groups with:

- Manual switched control
- Manual dimmed control with dimming actuators
- Automatic presence control
- Automatic brightness control with dimming actuators
- Constant light control with dimming actuators
- Multi group constant light control
- LED support on push buttons
- Green Leaf - RoomOptiControl
- Burn-in and operating hours function

Every DXR2.. controls up to 2 blinds with:

- Manual control
- Automatic control with anti glare function and energy efficiency function (requires facade control from central functions)
- Green Leaf - RoomOptiControl
- Collision detection

		
	LgtDev 1...4 Lighting	BlsDev 1...2 Shading
Number of outputs, Actuators for lighting (KNX PL-Link)	1-4	
Number of outputs, Actuators for shading (KNX PL-Link)		1-2

Room automation
Overview and selection tools
Configurable Room Automation Station with BACnet

Push buttons (KNX PL-link)



Features	UP 220/31	UP 221..	UP 222..	UP 223..	UP 285..	UP 286	UP 287..	P02	P37
Display									■
Mode selection									■
Fan switch									■
Setpoint adjuster									■
Operation of light and shading	■	■	■	■	■	■	■	■	■
Temperature sensor								■	■
Bus transceiver modules UP117		■	■	■	■	■	■		
Bus transceiver modules in lighting actuator UP510/03 or UP525/03		■	■	■	■	■	■		
Bus transceiver modules in shading actuator UP520/03		■	■	■	■	■	■		
Light control (1x toggle)	1	1	1		1	1		1	1
Light control (2x toggle)	1	1	1		1	1		1	1
Light control (3x toggle)	1		1			1		1	1
Light control (4x toggle)	1		1			1		1	1
Light control (1x dimming or switching)	1	1	1	1	1	1	1	1	1
Light control (2x dimming or switching)	1		1	1		1	1	1	1
Light control (3x dimming or switching)	2			1			1	1	1
Light control (4x dimming or switching)	2						1	1	1
Shading control (1x shading)	1	1	1		1	1		1	1
Shading control (2x shading)	1	2	1		2	1		1	1
Combined control (1x toggle and 1x shading)	1		1	1		1	1	1	1
Combined control (2x toggle and 1x shading)	1		1	1		1	1	1	1
Combined control (3x toggle and 1x shading)				1			1	1	1
Combined control (4x toggle and 1x shading)				1			1	1	1
Combined control (1x toggle and 2x shading)				1			1	1	1
Combined control (2x toggle and 2x shading)				1			1	1	1
Combined control (3x toggle and 2x shading)							1	1	1
Combined control (4x toggle and 2x shading)							1	1	1
Combined control (1x dimming or switching and 1x shading)	1		1	1		1	1	1	1
Combined control (2x dimming or switching and 1x shading)				1			1	1	1
Combined control (1x dimming or switching and 2x shading)				1			1	1	1
Combined control (2x dimming or switching and 2x shading)							1	1	1
Status LED		■	■	■	■	■	■		
Integration into DXR2...									
Data points	4	2	4	6	2	4	8	9	11
KNX PL-Link bus load (mA)	10	10	10	10	10	10	10	7.5	10

4







Room automation

Overview and selection tools

Configurable Room Automation Station with BACnet

4





Actuators for lighting (KNX PL-link)

	 UP 510/03	 UP 525/03	 UP 510/13	 UP 525/13	 RS 510/23	 RS 525/23	 RL 512/23
Applications							
Switching	■	■	■	■	■	■	■
Dimming (R, L, C)		■		■		■	
Outputs							
Number of outputs	2	1	2	1	2	1	1
Switching current (A)	10*		10*		10*		16**
Rated power (VA)		10...250		10...250		10...250	
Inputs							
Mounting							
Flush mount (under push buttons)	■	■					
Flush mount			■	■			
Room control box (AP 118/01)					■	■	■
Room control box (AP 641/01)					■	■	■
Integration into DXR2..							
Data points	2	1	2	1	2	1	1
KNX PL-link bus load (mA)	10	10	10	10	10	10	10

* For resistive loads

** For resistive loads, AX loads (200 µF) and direct current at 24 V DC

Actuators for shading (KNX PL-link)

	 UP 520/03	 UP 520/13	 RS 520/23	 RL 521/23
Applications				
Blinds with slats	■	■	■	■
Shutters	■	■	■	■
Outputs				
Number of outputs	1	1	1	2
Switching current (A)	6*	6*	6*	6*
Inputs				
Binary inputs (potential free contacts)				
Mounting				
Flush mount (under push buttons)	■			
Flush mount		■		
Room control box (AP 118/01)			■	■
Room control box (AP 641/01)			■	■
Integration into DXR2..				
Data points	2	2	2	4
KNX PL-link bus load (mA)	10	10	10	10

* For resistive loads

Central functions

Application can be configured from these functions:

- Central operation group including room operating mode and start optimization, setpoints and seasonal compensation, light, shading and forced emergency commands
- Demand controlled hot water supply system, includes temperature setpoint
- Demand controlled chilled water supply system, includes temperature setpoint, shift to avoid condensation by collecting condensation monitors, free cooling calculation
- Demand controlled 2 pipe heating / cooling water supply system includes temperature setpoint, changeover, free cooling calculation
- Demand controlled air handling unit (supply and extract air) includes temperature setpoint, maximum humidity setpoint, pressure setpoint, maintain minimal central air volume, flow deviation calculation, summed air volume setpoints
- Variable air volume (VAV) emergency group includes shut down, extract, pressurization or purge
- Central weather station information includes outside temperature, outside brightness, outside solar radiation, outside wind speed, outside precipitation
- Central facade functions for shading includes brightness calculation, central operation group for façade, glare protection calculation
- Shading central protection groups for Wind protection, Precipitation protection, Frost protection, staged distribution for central blind commands in large buildings



	Central Weather Station Controller					Central Facade Controller		
	Outside temperature	Relative outside humidity	Atmospheric pressure	Wind speed	Precipitation detector	Brightness with 1 sensor	Brightness with 3 sensor (E,S,W) (E,N,W)	Solar radiation
DI					1			
AI	1	1	1	1		1	1-3	1
Push button (KNX PL-Link)								
DXR2.. Type	DXR2..18..					DXR2..18..		

	Central HVAC Supply Controller			Central Emergency Controller				
	Operating mode groups	Light manual central operation	Shading manual central operation	Forced Emergency position for shading	Forced Emergency command for lighting	Forced Emergency shut down air supply	Forced Smoke extraction (exhaust air)	Forced Smoke pressurization (supply air)
DI	1-4			1	1	1-2	1-2	1-2
AI								
Push button (KNX PL-Link)		4*	4*					
DXR2.. Type	DXR2..18..			DXR2..18..				

* Either 1 device UP220 for 2 outputs or 2 devices UP221 / UP285 for 1 output each

Room automation

Overview and selection tools

Programmable Room Automation Station with BACnet

Programmable Room Automation Station with BACnet

4

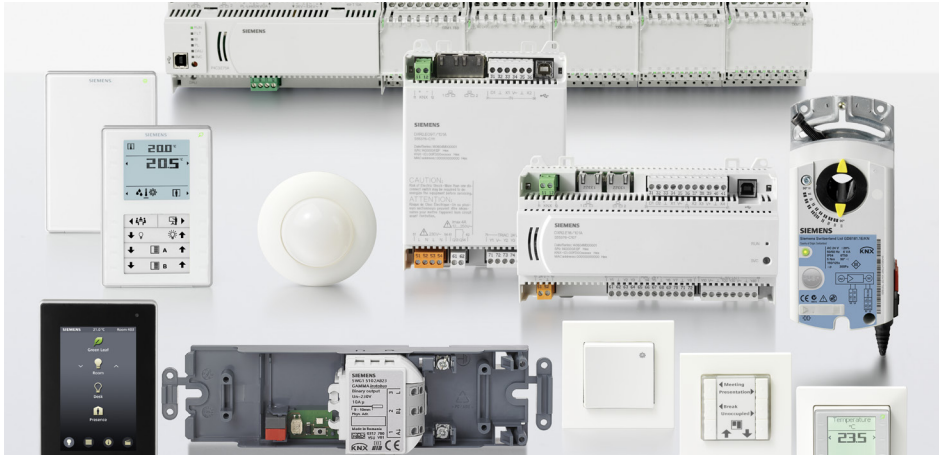

DXR2.. and PXC3.. room automation stations are programmable, based on proven application blocks. Solutions thus can be tailored to specific needs and allow to achieve maximum efficiency and comfort.



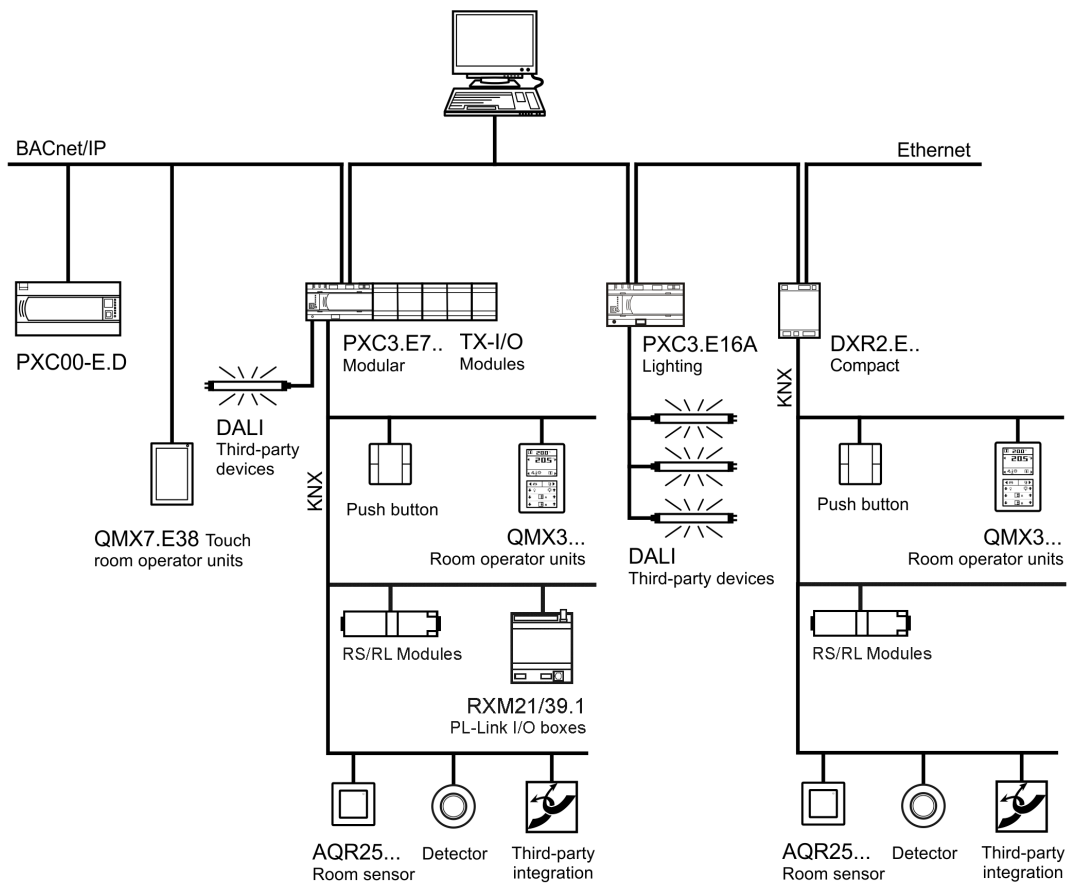

A comprehensive block library for room automation is provided as part the scope of delivery. The library contains predefined application functions for room climate, lighting, shading, and superimposed room functions. They can be combined to form individual solutions together with operating and display functions. The individual application functions can be adapted to customer needs and are fully programmable. The application functions do not depend on the selected field devices.

Topology for programmable room automation stations









Room automation
Overview and selection tools
Programmable Room Automation Station with BACnet

Modular room automation station with BACnet

				
	PXC3.E72	PXC3.E72A	PXC3.E75	PXC3.E75A
Max. numbers of rooms / room segments	4 / 8	4 / 8	8 / 16	8 / 16
System communication	BACnet / IP	BACnet / IP	BACnet / IP	BACnet / IP
System functions (BACnet)				
BACnet profiles	B-ASC	B-ASC	B-ASC	B-ASC
Programming	■	■	■	■
Peripheral bus				
Bus for I/O module	■	■	■	■
KNX PL-Link ¹⁾ / KNX S-Mode	■	■	■	■
DALI		■		■
Maximum configuration				
Inputs/Outputs for TX I/O modules	72	72	200	200
Devices on KNX PL-Link	64	64	64	64
DALI ballasts		64		64
Total data points	140	140	280	280
Integrated power supply for KNX (mA)	160	160	160	160

4

Overview I/O module TXM1..

							
Product	TXM1.8D	TXM1.16D	TXM1.8U	TXM1.6R	TXM1.6RL	TXM1.8RB	TXM1.8T
Number of Input/Output	8	16	8	6	6	8	8
Functionality							
3-colored I/O status LED	■						
Green colored I/O status LED		■	■	■	■	■	■
Digital inputs (DI)							
Message signal (open/closer)	■	■	■				
Message impulse	■	■	■				
Counter 25 Hz (Bouncer free)		■ ¹⁾	■				
Analog inputs (AI)							
LG-Ni1000			■				
Pt1000 / 0...2500 Ohm			■				
T1			■				
DC 0...10V			■				
Analog outputs (AO)							
DC 0...10V			■				
Digital outputs (DO)							
Continuous contact on/off				■			■
Continuous contact 3-stage				■			
3-point output (stroke model)				■			■
Impulse on/off				■			
Impulse				■			
Impulse 3-stage				■			
Bistable contact					■		
Contact for control of blinds						■	
Modulating (PWM)							■

All I/O points of a module are configurable on any, implemented functionality. The module TX11.OPEN enables the integration of Modbus, M-bus etc. on the PXC50/100/200..D.

¹⁾ On the TXM1.16D the counters are implemented only on the inputs 1 to 8

Room automation

Overview and selection tools

Programmable Room Automation Station with BACnet

Compact room automation station with BACnet



Communication	DXR2.E09-101A	DXR2.E09T-101A	DXR2.E10-101A	DXR2.M11-101A	DXR2.E12P-102A	DXR2.E18-1..A
BACnet/IP	DXR2.E09-101A	DXR2.E09T-101A	DXR2.E10-101A		DXR2.E12P-102A	DXR2.E18-1..A
BACnet MS/TP	DXR2.M09-101A	DXR2.M09T-101A	DXR2.M10-101A	DXR2.M11-101A	DXR2.M12P-102A	DXR2.M18-1..A
System functions (BACnet)						
BACnet profiles	B-ASC	B-ASC	B-ASC	B-ASC	B-ASC	B-ASC
Programming	■	■	■	■	■	■
Housing						
DIN				■	■	■
Flat	■	■	■			
Operating voltage						
230V	■	■	■			
24V				■	■	■
Inputs and outputs onboard						
Digital inputs	1	1	1	1	1	2
Universal inputs	2	2	2	2	2	4
Relay outputs	3	1	3			
Triac outputs		4	4	6	6	8
Analog outputs (DC 0...10 V)	3	1		2	2	4
Pressure sensor					1	
Maximum configuration						
Total data points	30	30	30	30	30	60
Integrated power supply for KNX (mA)	50	50	50	50	50	50

Room units and field devices

All room units and other KNX PL-link devices shown in part "Configurable room automation station" can be used also with programmable room automation station. Additionally, following devices can be used.







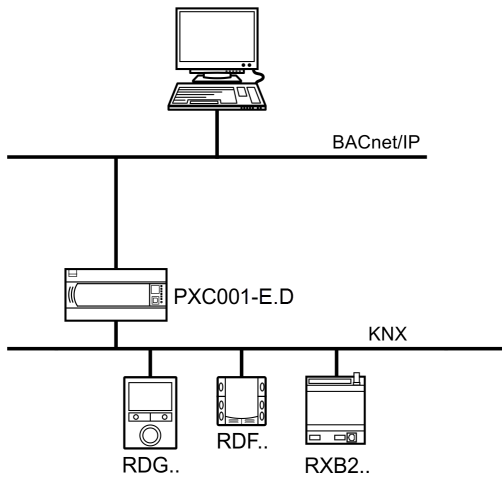

	Product No.	SSN	Description
	QMX7.E38	QMX7.E38	Touch room operator unit 4.3 inch for use with PXC3.E7.. and DXR2..E.. series room automation station
	RXM21.1	S55376-C104	I/O block with KNX PL-Link for use with a PXC3.E7.. series room automation station
	RXM39.1	S55376-C105	I/O block with KNX PL-Link for use with a PXC3.E7.. series room automation station
	RL 513	5WG1 513-4DB23	Binary Output (relay), 3 x AC 230 V, 6 A
	RL 260/23	5WG1 260-4AB23	4-fold binary input, AC/DC12...230V
	UP 255D21	5WG1 255-2DB21	Brightness sensor
	PXC3.E16A-100A	S55376-C118	BACnet / IP - DALI Gateway

Room Automation with KNX

Topology



Thermostat with KNX

									
Type	RDG100KN	RDG160KN	RDG400KN	RDF800KN	RDF600KN	RDF301	RDF301.50	RDF301.50H	RDU341
Applications									
Fancoil 2-/4-pipe	■	■		■	■	■	■	■	
Fancoil with electrical heater	■	■		■	■	■	■	■	
Fancoil with Radiator	■	■							
Heating / Cooling 2-/4-pipe	■	■		■					
Heat Pump System		■		■	■	■	■		
Variable Air Volume (VAV)			■						■
VAV with electrical heater			■						■
VAV with radiator / Heat-Cool coil			■						
Design									
Wall mounted	■	■	■						
Semi-Flush Mounted for VDE/CEE box				■	■	■	■	■	■
for British Standard box				■	■	■	■	■	■
Touch Screen Display				■					
Buttons for light and blind control							■		
Button for Hotel application								■	
Power supply									
Terminal voltage AC 230 V	■			■	■	■	■	■	
Terminal voltage AC 24 V		■	■						■
Inputs									
Multifunctional inputs digital/analog	3	3	3	2	2	2	2	2	2
Outputs									
ON/OFF (PWM) Triac (H/C)	■		■						
ON/OFF Relay (H/C)		■		■	■	■	■	■	■
Analog outputs DC 0..10V (H/C)		■	■						■
3-stage Relay (fan)	■	■		■	■	■	■	■	
Analog DC 0..10 V (fan)		■							

Room automation

Overview and selection tools

Room Automation with KNX

Compact Room Controller RXB with KNX

RXB applications

RXB hardware

The product range comprises compact controllers and corresponding room units for comfortable control. The compact room controllers are optimized to the respective application with regard to input/output configuration. HVAC functions are operated via standard room units.

Communication is based on KNX S-mode. The fan coil room controllers communicate also in KNX LTE mode. KNX LTE mode is used for to communicate with control equipment from the Synco™ 700 product range.

RXB software

Each RXB unit comes with preloaded application software featuring one or several applications (see next page).

The ETS software helps engineer and commission a network with RXB units.

In addition, the Synco™ tool... and room unit QAX34.3 by Siemens can be used for commissioning and parameterization.

Connection to the Desigo building automation and control system

Desigo PX KNX allow for flexibly connecting RXB controllers to the Desigo building automation and control system, and hence acts as a gateway to BACnet. The connection provides access to other functions such as time schedules and central control of setpoints.

RXB thus fits into the overall expandable modular system, and ensures long-term cost-efficiency.

Integration into Synco™

The Synco™ central control unit RMB795 is used for controlling and monitoring the RXB controllers in a Synco™ system.

4

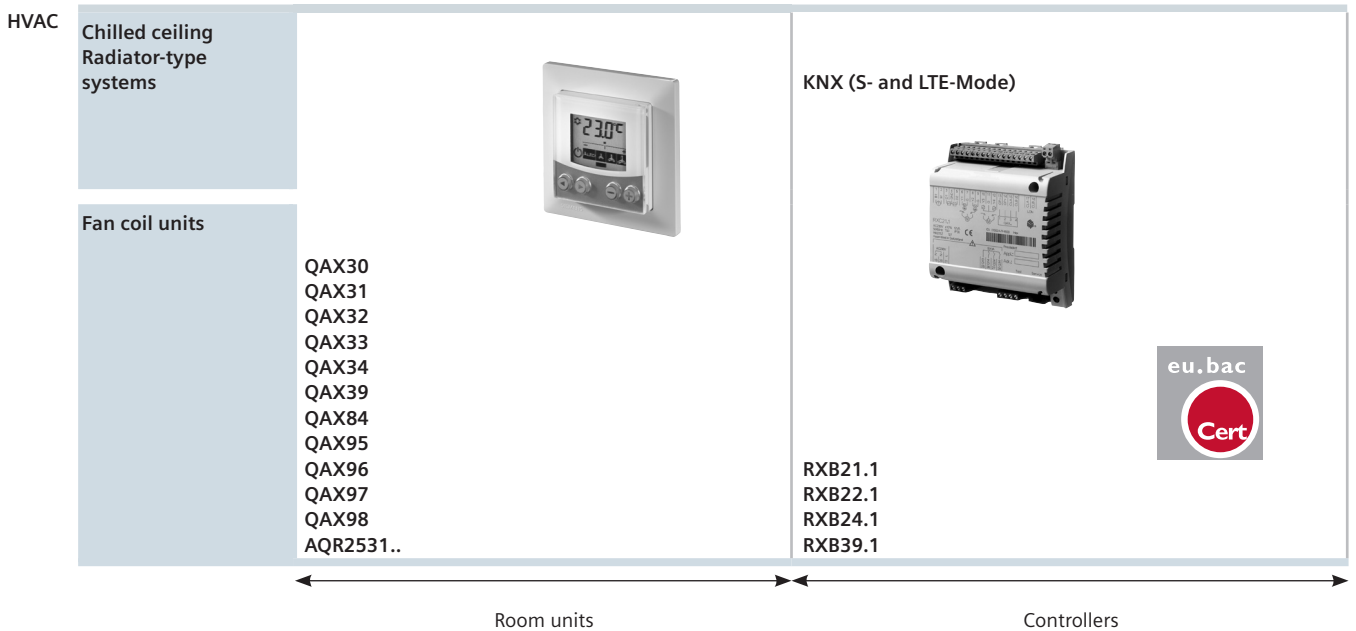

Fields of application

The scope of RXB is defined by the preprogrammed application software. The following pages provide an overview of the options and the corresponding devices, divided into different areas of application. The devices are supplied preprogrammed with the applications. The required application can be selected by means of the ETS, Synco™ tool or the Handy tool QAX34.3.

Due to the fact that the applications are predefined, engineering simply involves the definition of a small number of parameters, e. g.:

- PWM or 3-position control of the valves and actuators
- Temperature setpoints
- Manual or automatic fan control
- Room operating units QAX3..., QAX84.1 (PPS2 interface)

Fan coil systems

Application	Description	Devices
FNC02	2-pipe system with changeover	RXB21.1/FC-10
FNC03	2-pipe system with changeover and electrical reheater	RXB22.1/FC-12
FNC04	4-pipe system	RXB21.1/FC-10
FNC05	4-pipe system with electrical reheater	RXB22.1/FC-12
FNC08	4-pipe system with supply air temperature limitation	RXB21.1/FC-10
FNC10	2-pipe system with changeover and outside air damper	RXB21.1/FC-11
FNC12	4-pipe system with outside damper	RXB21.1/FC-11
FNC18	2-pipe system with change over and radiator	RXB21.1/FC-11
FNC20	4-pipe system with air-side control	RXB21.1/FC-10
FNC02/03/04/08	2-pipe/4-pipe system with EC fan-coil support	RXB39.1/FC13

Common functions

- Window contact, occupancy detector, 4 operating modes
- Manual fan control with room unit
- Automatic fan control (RXB21.1/RXB22.1 three speed; RXB39.1 continuous fan speed 0..10V)
- Options for 2-pipe systems: heating only, cooling only or change-over, via KNX bus

Heated/chilled ceilings and radiators

Application	Description	Devices
CLC01	Chilled ceiling with dewpoint monitoring	RXB24.1/CC-02
CLC02	Chilled ceiling with dewpoint monitoring and radiator	RXB24.1/CC-02
RAD01	Radiator with downdraft compensation	RXB24.1/CC-02

Common functions

- Window contact, occupancy detector, 4 operating modes

Room automation

Overview and selection tools

Room Automation with LON

Room Automation with LON

RXC applications

RXC hardware

RXC is a comprehensive range of room controllers for HVAC automation, extension modules for lighting and blinds, and a graded range of purposedesigned room units. LONWORKS technology is used for data communications.

The range consists of compact and modular room controllers, user-friendly room operator units and controllers in room-style housings.

RXC software

Each room controller contains downloadable application software (referred to as the "application") with the optimum control programs for the room or area concerned.

Siemens maintains a comprehensive library of reliable, field-proven applications for HVAC and electrical applications.

Connection to the Desigo building automation and control system

Extension modules PXX-L.. together with the modular automation stations PXC..D allow for flexibly connecting RXC controllers to the Desigo building automation and control system, and hence acts as a gateway to BACnet. The connection provides access to other functions such as time schedules and central control of setpoints.

RXC thus fits into the overall expandable modular system, and ensures long-term cost-efficiency.

4

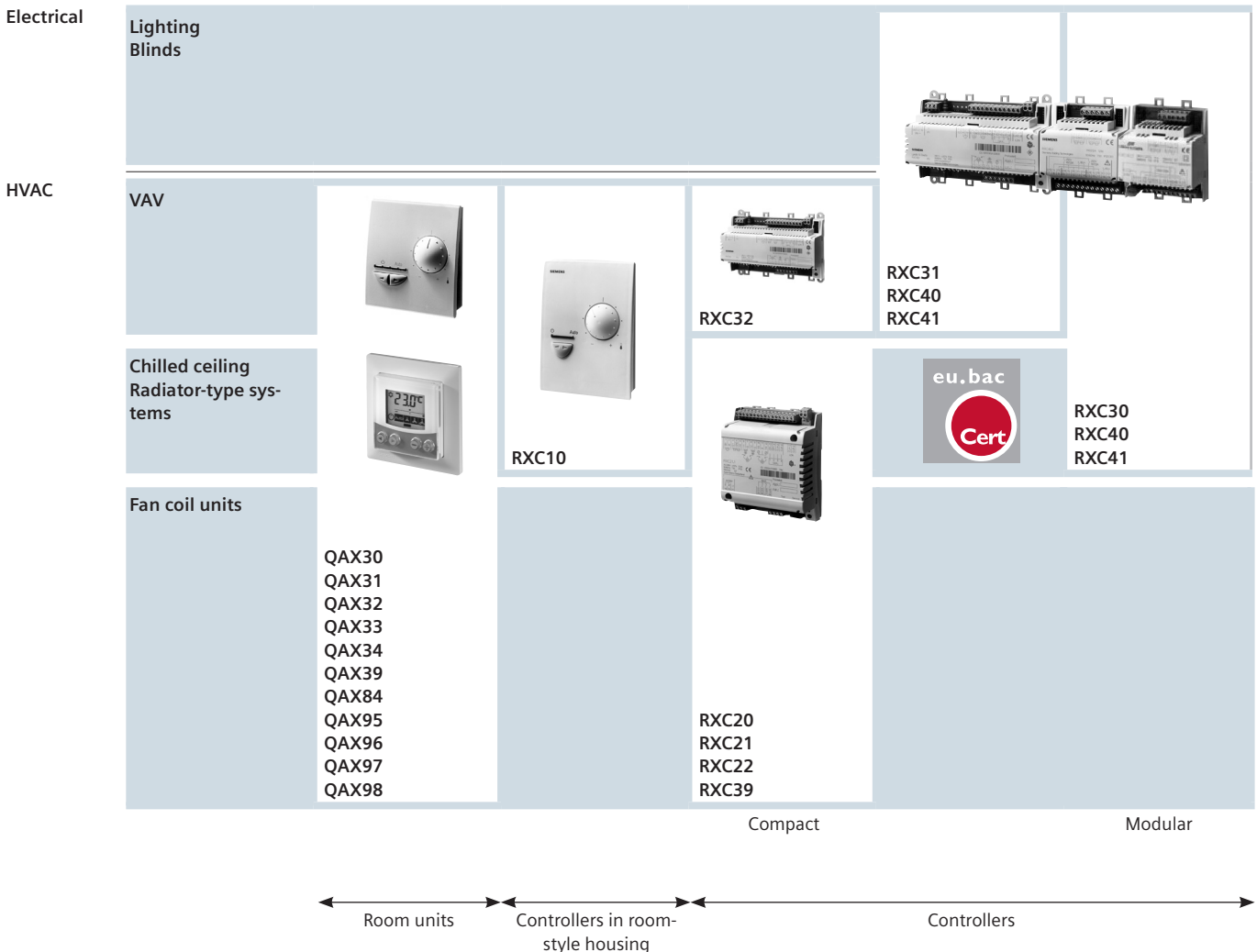

Fields of application

The scope of RXC is defined by the pre-programmed application software. The following pages provide an overview of the options and the corresponding devices, divided into different areas of application. The devices are supplied pre-programmed with the application required. Other applications can be loaded using the RXT10.5 commissioning and service tool, which contains the entire applications library.

Due to the fact that the applications are largely predefined, engineering simply involves the definition of a small number of parameters, e. g.:

- PWM or 3-point control of the valves and actuators
- Temperature setpoints
- Manual or automatic fan control

Basic applications

With the basic application software every RXC controller can also be used as an I/O module. The RXT10.5 commissioning and service tool can be used to observe the signals to the inputs or to process them further at the automation level or at the management level. Direct control of the controller outputs is also possible. Controllers ordered without reference to a specific application will be supplied factory-programmed with the appropriate basic application.

Application	Description
00010	Basic application for RXC10.5
00020	Basic application for RXC20.5
00021	Basic application for RXC21.5
00022	Basic application for RXC22.5
00030	Basic application for RXC30.5
00031	Basic application for RXC31.5
00032	Basic application for RXC32.5

Fan coil systems

Application	Description	Devices
FNC02	2-pipe system with changeover	RXC20.5 / RXC21.5
FNC03	2-pipe system with changeover and electric reheater	RXC20.5 / RXC21.5 / RXC22.5
FNC04	4-pipe system	RXC20.5 / RXC21.5
FNC08	4-pipe system with supply air temperature limitation	RXC21.5
FNC10	2-pipe system with changeover and outside air damper	RXC21.5
FNC12	4-pipe system with outside air damper	RXC21.5
FNC18	2-pipe system (cooling) and radiator	RXC20.5 / RXC21.5
FNC20	4-pipe system with air-side control	RXC20.5 / RXC21.5
FNC02/03/04/08	2-pipe/4-pipe system with EC fan-coil support	RXC39.5

Common functions

- Window contact, occupancy detector, 4 operating modes
- Manual fan control with room unit
- Automatic fan control (RXC20.5 single-speed, RXC21.5, RXC21.5 three-speed), 0..10 V (continuous speed with RXC39.5 only)
- Options for 2-pipe systems: heating only, cooling only or change-over, via LONWORKS bus

Heated/chilled ceilings and radiators

Application	Description	Devices
CLC01	Chilled ceiling	RXC20.5 / RXC10.5
CLC02	Chilled ceiling and radiator	RXC20.5 / RXC10.5
CLC03	Chilled ceiling and radiator	RXC20.5
CLC06	Chilled/heated ceiling, 2-pipe system with changeover via LONWORKS bus	RXC20.5 / RXC10.5
CLC07	Chilled/heated ceiling, 2-pipe system with changeover via LONWORKS bus and radiator	RXC20.5
CLC08	Chilled/heated ceiling, 4-pipe system and 2 PWM valves for changeover	RXC21.5
CLC09	Divided chilled/heated ceiling: Cooling only and cooling/heating with changeover via LONWORKS bus	RXC20.5 / RXC21.5
RAD01	LPHW radiators	RXC20.5 / RXC10.5
RAD03	Electric radiators	RXC20.5 / RXC10.5

Common functions

- Window contact, occupancy detector, 4 operating modes
- Dewpoint sensor

Room automation

Overview and selection tools

Room units for RXB and RXC

Room units LONWORKS/PPS2



Features	30.1	31.1	32.1	QAX.. 33.1	34.3	39.1	84.1
Display					■		■
Mode selection			■	■	■		■
Fan switch				■	■		■
Setpoint adjuster		■	■	■	■	■	■
Operation of light/blindes							
Temperature sensor	■	■	■	■	■		■
Mounting							
Flush-mounted						■	■
Directly on wall	■	■	■	■	■		
Control panel(door)						■	
Communication							
PPS2	■	■	■	■	■	■	■
LONWORKS							
Product range							
Desigo RX RXB..	■	■	■	■	■	■	■
RXC..	■	■	■	■	■	■	■

4

Compact room automation station, BACnet/IP, 230 V, flat housing, 1 DI, 2 UI, 3 relay, 3 AO

DXR2.E09-101A

Compact room automation stations for HVAC, lighting, and shading:

- BACnet/IP communications
- KNX PL-Link bus to connect sensors, actuators, and operator units (including bus power)
- KNX S-Mode device integration
- 2-port Ethernet switch
- USB interface for Tool



Data sheet	N9204
Operating voltage	AC 230 V
Power consumption	24 VA
Frequency	50/60 Hz
Analog output, signal	DC 0...10 V
Analog outputs, number	3
Analog output, current	1 mA
Universal inputs, number	2
Relay outputs, number	3
Relay output, switching voltage	AC 250 V
Relay output, switching current	4 (3) A
Mounting	On DIN rail or wall
Communication	BACnet/IP KNX PL-Link KNX S-Mode
Degree of protection	IP20
Dimensions (W x H x D)	112 x 49 x 165 mm



4

Stock No.

Product No.

S55376-C110

DXR2.E09-101A

NEW PRODUCT

DXR2.E09T-101A



Compact room automation station, BACnet/IP, 230 V, flat housing, 1 DI, 2 UI, 1 relay, 1 AO, 4 triac

Compact room automation stations for HVAC, lighting, and shading:

- BACnet/IP communications
- KNX PL-Link bus to connect sensors, actuators, and operator units (including bus power)
- KNX S-Mode device integration
- 2-port Ethernet switch
- USB interface for Tool



Data sheet	N9204
Operating voltage	AC 230 V
Power consumption	24 VA
Frequency	50/60 Hz
Analog output, signal	DC 0...10 V
Analog outputs, number	1
Analog output, current	1 mA
Universal inputs, number	2
Relay outputs, number	1
Relay output, switching voltage	AC 250 V
Relay output, switching current	4 (3) A
Triac outputs, number	4
Triac output, switching voltage	AC 24 V
Triac output, switching current	150 mA
Mounting	On DIN rail or wall
Communication	BACnet/IP KNX PL-Link KNX S-Mode
Degree of protection	IP20
Dimensions (W x H x D)	112 x 49 x 165 mm

Stock No.

Product No.

S55376-C111

DXR2.E09T-101A

4

Compact room automation station, BACnet/IP, 230 V, flat housing, 1 DI, 2 UI, 3 relay, 4 triac

DXR2.E10-101A

Compact room automation stations for HVAC, lighting, and shading:

- BACnet/IP communications
- KNX PL-Link bus to connect sensors, actuators, and operator units (including bus power)
- KNX S-Mode device integration
- 2-port Ethernet switch
- USB interface for Tool



Data sheet	N9204
Operating voltage	AC 230 V
Power consumption	24 VA
Frequency	50/60 Hz
Universal inputs, number	2
Relay outputs, number	3
Relay output, switching voltage	AC 250 V
Relay output, switching current	4 (3) A
Triac outputs, number	4
Triac output, switching voltage	AC 24 V
Triac output, switching current	150 mA
Mounting	On DIN rail or wall
Communication	BACnet/IP KNX PL-Link KNX S-Mode
Degree of protection	IP20
Dimensions (W x H x D)	112 x 49 x 165 mm



Stock No.

Product No.

S55376-C109

DXR2.E10-101A

NEW PRODUCT

Room automation

Desigo TRA

Compact room automation stations BACnet/IP DXR2.E..

DXR2.E12P-102A



Compact room automation station, BACnet/IP, 24 V, DIN housing, 1 DI, 2 UI, 2 AO, 6 triac, pressure sensor

Compact room automation stations for HVAC, lighting, and shading:

- BACnet/IP communications
- KNX PL-Link bus to connect sensors, actuators, and operator units (including bus power)
- KNX S-Mode device integration
- 2-port Ethernet switch
- USB interface for Tool

Data sheet	N9205
Operating voltage	AC 24 V
Power consumption	70 VA
Frequency	50/60 Hz
Analog output, signal	DC 0...10 V
Analog outputs, number	2
Analog output, current	1 mA
Universal inputs, number	2
Triac outputs, number	6
Triac output, switching voltage	AC 24 V
Triac output, switching current	250 mA
Mounting	On DIN rail or wall
Communication	BACnet/IP KNX PL-Link KNX S-Mode
Degree of protection	IP20
Dimensions (W x H x D)	180 x 60 x 105 mm

Stock No.

Product No.

S55376-C108

DXR2.E12P-102A

Compact room automation stations BACnet/IP DXR2.E..

Compact room automation station, BACnet/IP, 24 V, DIN housing, 2 DI, 4 UI, 4 AO, 8 triac

DXR2.E18..

Compact room automation stations for HVAC, lighting, and shading:

- BACnet/IP communications
- KNX PL-Link bus to connect sensors, actuators, and operator units (including bus power)
- KNX S-Mode device integration
- 2-port Ethernet switch
- USB interface for Tool



Data sheet	N9205
Operating voltage	AC 24 V
Power consumption	78 VA
Frequency	50/60 Hz
Analog output, signal	DC 0...10 V
Analog outputs, number	4
Analog output, current	1 mA
Universal inputs, number	4
Triac outputs, number	8
Triac output, switching voltage	AC 24 V
Triac output, switching current	250 mA
Mounting	On DIN rail or wall
Communication	BACnet/IP KNX PL-Link KNX S-Mode
Degree of protection	IP20
Dimensions (W x H x D)	180 x 60 x 105 mm

Range overview DXR2.E18..

Additional info	Stock No.	Product No.
Applications: Fancoil, Radiant ceiling, Radiator, 4 Lights & 2 Shades	S55376-C107	DXR2.E18-101A
Applications: Variable air volume, Fan-powered box, Radiant ceiling, Radiator, 4 Lights & 2 Shades	S55376-C128	DXR2.E18-102A

NEW PRODUCT

DXR2.M09-101A

Compact room automation station, BACnet/MSTP, 230 V, flat housing, 1 DI, 2 UI, 3 relay, 3 AO



Compact room automation stations for HVAC, lighting, and shading:

- BACnet/MSTP communications
- KNX PL-Link bus to connect sensors, actuators, and operator units (including bus power)
- USB interface for Tool

Data sheet	N9206
Operating voltage	AC 230 V
Power consumption	23 VA
Frequency	50/60 Hz
Analog output, signal	DC 0...10 V
Analog outputs, number	3
Analog output, current	1 mA
Universal inputs, number	2
Relay outputs, number	3
Relay output, switching voltage	AC 250 V
Relay output, switching current	4 (3) A
Mounting	On DIN rail or wall
Communication	BACnet/MSTP KNX PL-Link
Degree of protection	IP20
Dimensions (W x H x D)	112 x 49 x 165 mm



Stock No. Product No.

S55376-C116

DXR2.M09-101A

DXR2.M09T-101A

Compact room automation station, BACnet/MSTP, 230 V, flat housing, 1 DI, 2 UI, 1 relay, 1 AO, 4 triac



Compact room automation stations for HVAC, lighting, and shading:

- BACnet/MSTP communications
- KNX PL-Link bus to connect sensors, actuators, and operator units (including bus power)
- USB interface for Tool

Data sheet	N9206
Operating voltage	AC 230 V
Power consumption	23 VA
Frequency	50/60 Hz
Analog output, signal	DC 0...10 V
Analog outputs, number	1
Analog output, current	1 mA
Universal inputs, number	2
Relay outputs, number	1
Relay output, switching voltage	AC 250 V
Relay output, switching current	4 (3) A
Triac outputs, number	4
Triac output, switching voltage	AC 24 V
Triac output, switching current	150 mA
Mounting	On DIN rail or wall
Communication	BACnet/MSTP KNX PL-Link
Degree of protection	IP20
Dimensions (W x H x D)	112 x 49 x 165 mm



Stock No. Product No.

S55376-C117

DXR2.M09T-101A

Compact room automation stations BACnet/MSTP DXR2.M..

**Compact room automation station, BACnet/MSTP, 230 V, flat housing, 1 DI, 2 UI,
3 relay, 4 triac**

DXR2.M10-101A

Compact room automation stations for HVAC, lighting, and shading:

- BACnet/MSTP communications
- KNX PL-Link bus to connect sensors, actuators, and operator units (including bus power)
- USB interface for Tool

Data sheet	N9206
Operating voltage	AC 230 V
Power consumption	23 VA
Frequency	50/60 Hz
Universal inputs, number	2
Relay outputs, number	3
Relay output, switching voltage	AC 250 V
Relay output, switching current	4 (3) A
Triac outputs, number	4
Triac output, switching voltage	AC 24 V
Triac output, switching current	150 mA
Mounting	On DIN rail or wall
Communication	BACnet/MSTP KNX PL-Link
Degree of protection	IP20
Dimensions (W x H x D)	112 x 49 x 165 mm



Stock No.

Product No.

S55376-C115

DXR2.M10-101A

**Compact room automation station, BACnet/MSTP, 24 V, DIN housing, 1 DI, 2 UI,
2 AO, 6 triac**

DXR2.M11-101A

Compact room automation stations for HVAC, lighting, and shading:

- BACnet/MSTP communications
- KNX PL-Link bus to connect sensors, actuators, and operator units (including bus power)
- USB interface for Tool

Data sheet	N9207
Operating voltage	AC 24 V
Power consumption	68 VA
Frequency	50/60 Hz
Analog output, signal	DC 0...10 V
Analog outputs, number	2
Analog output, current	1 mA
Universal inputs, number	2
Triac outputs, number	6
Triac output, switching voltage	AC 24 V
Triac output, switching current	250 mA
Mounting	On DIN rail or wall
Communication	BACnet/MSTP KNX PL-Link
Degree of protection	IP20
Dimensions (W x H x D)	180 x 60 x 105 mm



Stock No.

Product No.

S55376-C112

DXR2.M11-101A

NEW PRODUCT

Room automation

Desigo TRA

Compact room automation stations BACnet/MSTP DXR2.M..

DXR2.M12P-102A



Compact room automation station, BACnet/MSTP, 24 V, DIN housing, 1 DI, 2 UI, 2 AO, 6 triac, pressure sensor

Compact room automation stations for HVAC, lighting, and shading:

- BACnet/MSTP communications
- KNX PL-Link bus to connect sensors, actuators, and operator units (including bus power)
- USB interface for Tool

Data sheet	N9207
Operating voltage	AC 24 V
Power consumption	68 VA
Frequency	50/60 Hz
Analog output, signal	DC 0...10 V
Analog outputs, number	2
Analog output, current	1 mA
Universal inputs, number	2
Triac outputs, number	6
Triac output, switching voltage	AC 24 V
Triac output, switching current	250 mA
Mounting	On DIN rail or wall
Communication	BACnet/MSTP KNX PL-Link
Degree of protection	IP20
Dimensions (W x H x D)	180 x 60 x 105 mm

Stock No.

Product No.

S55376-C114

DXR2.M12P-102A

Compact room automation stations BACnet/MSTP DXR2.M..

**Compact room automation station, BACnet/MSTP, 24 V, DIN housing, 2 DI, 4 UI,
4 AO, 8 triac**

DXR2.M18..

Compact room automation stations for HVAC, lighting, and shading:

- BACnet/MSTP communications
- KNX PL-Link bus to connect sensors, actuators, and operator units (including bus power)
- USB interface for Tool



Data sheet	N9207
Operating voltage	AC 24 V
Power consumption	76 VA
Frequency	50/60 Hz
Analog output, signal	DC 0...10 V
Analog outputs, number	4
Analog output, current	1 mA
Universal inputs, number	4
Triac outputs, number	8
Triac output, switching voltage	AC 24 V
Triac output, switching current	250 mA
Mounting	On DIN rail or wall
Communication	BACnet/MSTP KNX PL-Link
Degree of protection	IP20
Dimensions (W x H x D)	180 x 60 x 105 mm



4

Range overview DXR2.M18..

Additional info	Stock No.	Product No.
Applications: Fancoil, Radiant ceiling, Radiator, 4 Lights & 2 Shades	S55376-C113	DXR2.M18-101A
Applications: Variable air volume, Fan-powered box, Radiant ceiling, Radiator, 4 Lights & 2 Shades	S55376-C129	DXR2.M18-102A

Accessories for Desigo DXR2..

Product Title	Stock No.	Product No.
Terminal cover for DXR.., 180 mm, 2 pieces	S55376-C120	DXA.H180
Terminal cover for DXR.., 110 mm, 2 pieces	S55376-C119	DXA.H110

NEW PRODUCT

Room automation

Desigo TRA

Modular room automation stations PXC3..

PXC3.E..



Room automation stations

Modular, freely programmable room automation station for HVAC, lighting and shading (TRA, Total Room Automation):

- BTL tested BACnet/IP communication according to BACnet standard (rev 1.13) include B-ASC profile
- Island bus to connect TX-I/O modules with any data point mix (including bus supply) (not with PXC3.E16A)
- KNX bus for direct connection of peripheral devices using KNX PL-Link or KNX S-mode communication (including bus supply) (not with PXC3.E16A)
- DALI bus to connect lighting controls (only controller types PXC3...A)
- USB interface for tool
- Mounting on standard mounting rail
- 2-port Ethernet switch for low-cost cabling

Data sheet	N9203
Operating voltage	AC 24 V
Frequency	50/60 Hz
Degree of protection	IP20
Dimensions (W x H x D)	162 x 74 x 90 mm

Range overview PXC3.E.. for Desigo V5

Product Title	Communication	Data sheet	Stock No.	Product No.
Room automation station BACnet / IP, for up to 4 rooms / 8 room segments	BACnet / IP KNX PL-Link / S-Mode Island bus	N9203	S55376-C100	PXC3.E72
Room automation station BACnet / IP and DALI, for up to 4 rooms / 8 room segments	BACnet / IP KNX PL-Link / S-Mode DALI Island bus	N9203	S55376-C101	PXC3.E72A
Room automation station BACnet / IP, for up to 8 rooms / 16 room segments	BACnet / IP KNX PL-Link / S-Mode Island bus	N9203	S55376-C102	PXC3.E75
Room automation station BACnet / IP and DALI, for up to 8 rooms / 16 room segments	BACnet / IP KNX PL-Link / S-Mode DALI Island bus	N9203	S55376-C103	PXC3.E75A

Range overview PXC3.E.. for Desigo V6

Product Title	Communication	Data sheet	Stock No.	Product No.
Room automation station BACnet / IP and DALI	BACnet / IP DALI	N9203	S55376-C118	PXC3.E16A-100A
Room automation station BACnet / IP, for up to 4 rooms / 8 room segments	BACnet / IP KNX PL-Link / S-Mode Island bus	N9203	S55376-C130	PXC3.E72-100A
Room automation station BACnet / IP and DALI, for up to 4 rooms / 8 room segments	BACnet / IP KNX PL-Link / S-Mode DALI Island bus	N9203	S55376-C131	PXC3.E72A-100A
Room automation station BACnet / IP, for up to 8 rooms / 16 room segments	BACnet / IP KNX PL-Link / S-Mode Island bus	N9203	S55376-C132	PXC3.E75-100A
Room automation station BACnet / IP and DALI, for up to 8 rooms / 16 room segments	BACnet / IP KNX PL-Link / S-Mode DALI Island bus	N9203	S55376-C133	PXC3.E75A-100A



NEW PRODUCT

Room automation

Desigo TRA

Room unit with KNX PL-Link

QMX3..



Room sensor and unit for KNX PL-Link, freely configurable, flush-mounted

The flush-mounted room unit QMX3.. consists of:

- Operator unit
- Bezel, titanium white
- Base plate and KNX plug.

Functionality:

- Freely configurable user interface (keys and visual items) as part of Total Room Automation
- RoomOptiControl energy efficiency function
- Room temperature measurement
- Display of room temperature, control mode, scenes etc. (dot matrix LCD)
- Backlit display, white or blue selection
- KNX PL-Link interface to the room automation station with plug & play functionality
- Can be combined with different standard and design bezels

Data sheet	N1601
Measuring range, temperature	0...50 °C
Sensing element, temperature	NTC
Degree of protection	IP30
Mounting	Flush or wall-mounted conduit box
Dimensions (W x H x D)	55 x 55 x 38 mm

Range overview QMX3..

Product Title	Stock No.	Product No.
Room unit for KNX PL-Link, freely configurable, flush-mounted with square bezel	S55624-H100	QMX3.P36F
Room unit for KNX PL-Link, freely configurable, flush-mounted with landscape bezel (3 modules landscape)	S55624-H101	QMX3.P36G

AQR2570..



Base module with KNX for temperature and humidity measurement

Data sheet	N1411
Voltage supply	KNX bus
Communication	KNX S-mode KNX LTE-mode KNX PL-Link
Analog inputs	Passive temperature sensor NTC 10k
Analog inputs, number	1
Digital inputs	Potential-free contacts
Digital inputs, number	2
Connection, electrical	Bus connection: spring terminal sensor inputs: 4 screw terminals

Range overview AQR2570..

Mechanical design	Dimensions (W x H)	Stock No.	Product No.
EU (CEE/VDE)	70.8 x 70.8 mm	S55720-S203	AQR2570NF
UK (British Standard)	83 x 83 mm	S55720-S204	AQR2570NH
IT (3 Modular)	110 x 64 mm	S55720-S205	AQR2570NG
US (UL)	64 x 110 mm	S55720-S206	AQR2570NJ

Base modules with KNX for CO₂ measurement

AQR2576..



Data sheet	N1411
Voltage supply	KNX bus
Communication	KNX S-mode KNX LTE-mode KNX PL-Link
Analog inputs	Passive temperature sensor NTC 10k
Analog inputs, number	1
Digital inputs	Potential-free contacts
Digital inputs, number	2
Measuring range	CO ₂ : 0...5000 ppm
Connection, electrical	Bus connection: spring terminal sensor inputs: 4 screw terminals



Range overview AQR2576..

Mechanical design	Dimensions (W x H)	Stock No.	Product No.
EU (CEE/VDE)	70.8 x 70.8 mm	S55720-S207	AQR2576NF
UK (British Standard)	83 x 83 mm	S55720-S208	AQR2576NH
IT (3 Modular)	110 x 64 mm	S55720-S209	AQR2576NG
US (UL)	64 x 110 mm	S55720-S210	AQR2576NJ

Front modules for base modules

AQR253..



Data sheet	N1410
Color	Titanium white
Degree of protection	IP30
Dimensions (W x H)	55 x 55 mm

Range overview AQR253..

Measuring range, temperature	Signal output temperature	Measurement range humidity	Stock No.	Product No.
0...50 °C	Active		S55720-S136	AQR2532NNW
		0...100 %	S55720-S140	AQR2533NNW
0...50 °C	Active	0...100 %	S55720-S141	AQR2535NNW
			S55720-S137	AQR2530NNW
0...50 °C	Active	0...100 %	S55720-S219	AQR2535NNWQ

Room automation

Desigo TRA

Room unit with KNX PL-Link

QMX3..

Wall-mounted room sensors and operator units for KNX

The wall-mounted room unit QMX3.. consists of:

- Base plate
- Sensor or room operator unit

The following functions are (depending on type):

- Temperature sensor or multisensor (T, r.h., CO2)
- Backlit display or LED display
- Touchkeys
- Switching and control of lighting, blinds, scenes

Data sheet	N1602
Measuring range, temperature	0...50 °C
Sensing element, temperature	NTC
Degree of protection	IP30
Mounting	Wall-mounting
Communication	KNX PL-Link KNX S-Mode
Dimensions (W x H x D)	88.4 x 133.4 x 18 mm

QMX3.P30

Room sensor KNX for temperature

Functions:

- Temperature sensor



Stock No.

Product No.

S55624-H103

QMX3.P30

QMX3.P70

Room sensor KNX for temperature, humidity, CO2

Functions:

- multisensor for temperature, humidity and CO2
- Air quality indicator with LED



Stock No.

Product No.

S55624-H104

QMX3.P70

Room operator unit KNX with temperature sensor, segmented backlit display, touchkeys

QMX3.P34

Functions:

- Temperature sensor
- Segmented backlit display and touchkeys
- "Green Leaf" LED



Stock No.

Product No.

S55624-H105

QMX3.P34

Room operator unit KNX with sensors for temperature, humidity, CO2, segmented backlit display, touchkeys

QMX3.P74

Functions:

- multisensor for temperature, humidity and CO2
- Segmented backlit display and touchkeys
- "Green Leaf" LED



Stock No.

Product No.

S55624-H106

QMX3.P74

Room operator unit KNX with temperature sensor, configurable touchkeys, LED display

QMX3.P02

Functions:

- Temperature sensor
- Configurable touchkeys with LED display
- Switching and control of lighting, blinds, scenes
- Window for labels



Stock No.

Product No.

S55624-H107

QMX3.P02

QMX3.P37



Room operator unit KNX with temperature sensor, segmented backlit display, configurable touchkeys, LED display

Functions:

- Temperature sensor
- Segmented backlit display and touchkeys
- Configurable touchkeys with LED display
- Switching and control of lighting, blinds, scenes
- Window for labels
- "Green Leaf" LED

4

Stock No.

Product No.

S55624-H108

QMX3.P37

QMX7.E38



Touch room operator unit 4.3 inch

- High quality, TFT display 4.3" with 262,000 colors and glass surface in aluminum metal housing for use with Desigo TRA.
- Resolution: 480 x 800 pixels (wide screen).
- IPS technology for wider viewing angle, more brilliant colors and higher contrast.
- Capacitive touch screen.
- Portrait and landscape application.
- Energy efficiency function ("Green Leaf ")
- Intuitive operation with text and exchangeable symbols.
- Navigate through multiple displays and operating pages.
- LED backlit, dimmed automatically.
- Brightness sensor for energy-saving background lighting.
- AC 24 V power supply or Power over Ethernet (PoE)
- Connected via Ethernet RJ45 connection.
- Compact design with low installation profile for flush mounting.
- Easy to install and includes theft protection.

Data sheet	N9295
Operating voltage	AC 24 V
Mounting	Flush-mounted conduit box
Communication	Ethernet / IP
Degree of protection	IP30
Dimensions (W x H x D)	88 x 132 x 15 mm

Stock No.

Product No.

S55624-H109

QMX7.E38

UP 220D31



Pushbutton interface, 4 x potential-free contact, output for LED control

- With 4 inputs / outputs each configurable for potential-free contacts or for control of an LED (max 2 mA)
- With integrated bus coupling unit, bus connection via bus terminal
- 8-wire plug-in cable set, 280 mm long, extendable to a max. of 10 m
- For insertion in flush-mounting switch and socket boxes 60 mm in diameter and 40 mm deep

Communication

KNX S-Mode

KNX PL-Link

Dimensions (W x H x D)

42 x 42 x 8.5 mm

Stock No.

Product No.

5WG1220-2DB31

UP 220D31

4

UP 22..



Pushbutton, i-system

- Pushbutton in pair
- Horizontal operation
- Per pushbutton selectable function
- Connectable bus coupling unit (BTM) or flush-mounted actuators via BTI

Design

Dimensions (W x H x D) 55 x 55 x 11 mm

Bus coupling unit (BTM) / flush mounted actuator and a design frame must be ordered as a separate items.

Range overview UP 22..

Product Title	Stock No.	Product No.
Pushbutton, single, without status LED, titanium white	5WG1221-2DB12	UP 221/12
Pushbutton, single, with status LED, titanium white	5WG1221-2DB13	UP 221/13
Pushbutton, single, without status LED, aluminum metallic	5WG1221-2DB32	UP 221/32
Pushbutton, single, with status LED, aluminum metallic	5WG1221-2DB33	UP 221/33
Pushbutton, double, without status LED, titanium white	5WG1222-2DB12	UP 222/12
Pushbutton, double, with status LED, titanium white	5WG1222-2DB13	UP 222/13
Pushbutton, double, without status LED, aluminum metallic	5WG1222-2DB32	UP 222/32
Pushbutton, double, with status LED, aluminum metallic	5WG1222-2DB33	UP 222/33
Pushbutton, triple, without status LED, titanium white	5WG1223-2DB12	UP 223/12
Pushbutton, triple, with status LED, titanium white	5WG1223-2DB13	UP 223/13
Pushbutton, triple, without status LED, aluminum metallic	5WG1223-2DB32	UP 223/32
Pushbutton, triple, with status LED, aluminum metallic	5WG1223-2DB33	UP 223/33

Room automation
Desigo TRA
Pushbutton with KNX PL-Link

UP 223/..5



Pushbutton with scene controller and IR receiver decoder, i-system

- Pushbutton in 3 pairs
- Horizontal operation
- Per pushbutton selectable function
- Connectable bus coupling unit (BTM) or flush-mounted actuators via BTI
- IR receiver for IR handheld transmitter S 425/72 or AP 42../13

Design

Dimensions (W x H x D) 55 x 55 x 11 mm

Bus coupling unit (BTM) / flush mounted actuator and a design frame must be ordered as a separate items.

4

Range overview UP 223/..5

Display	Color	Communication	Stock No.	Product No.
Status LED	Titanium white	IR receiver decoder (industry standard)	5WG1223-2DB15	UP 223/15
Status LED	Aluminum metallic	IR receiver decoder (industry standard)	5WG1223-2DB35	UP 223/35

UP 28..

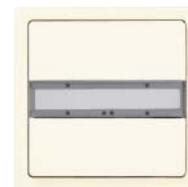

Pushbutton, DELTA style

- Pushbutton in pair
- Vertical operation
- Per pushbutton selectable function
- Connectable bus coupling unit (BTM) or flush-mounted actuators via BTI

Dimensions (W x H x D) 68 x 68 x 14 mm

Bus coupling unit (BTM) / flush mounted actuator and a design frame must be ordered as a separate items.

Range overview UP 28..

Product Title	Stock No.	Product No.
Pushbutton, single, without status LED, titanium white	5WG1285-2DB12	UP 285/12
Pushbutton, single, with status LED, titanium white	5WG1285-2DB13	UP 285/13
Pushbutton, single, without status LED, platinum metallic	5WG1285-2DB42	UP 285/42
Pushbutton, single, with status LED, platinum metallic	5WG1285-2DB43	UP 285/43
Pushbutton, double, without status LED, titanium white	5WG1286-2DB12	UP 286/12
Pushbutton, double, with status LED, titanium white	5WG1286-2DB13	UP 286/13
Pushbutton, double, without status LED, platinum metallic	5WG1286-2DB42	UP 286/42
Pushbutton, double, with status LED, platinum metallic	5WG1286-2DB43	UP 286/43
Pushbutton, quadruple, without status LED, titanium white	5WG1287-2DB12	UP 287/12
Pushbutton, quadruple, with status LED, titanium white	5WG1287-2DB13	UP 287/13
Pushbutton, quadruple, without status LED, platinum metallic	5WG1287-2DB42	UP 287/42
Pushbutton, quadruple, with status LED, platinum metallic	5WG1287-2DB43	UP 287/43

Room automation
Desigo TRA
Pushbutton with KNX PL-Link

UP 287/..5

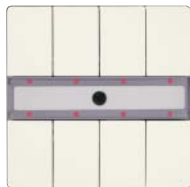

Pushbutton with scene controller and IR receiver decoder, DELTA style

- Pushbutton in 4 pairs
- Vertical operation
- Per pushbutton selectable function
- IR receiver for IR handheld transmitter S 425/72 or AP 42../13
- Connectable bus coupling unit (BTM) or flush-mounted actuators via BTI

Design

Dimensions (W x H x D)

68 x 68 x 14 mm

4

Range overview UP 287/..5

Display	Color	Communication	Stock No.	Product No.
Status LED	Titanium white	IR receiver decoder (industry standard)	5WG1287-2DB15	UP 287/15
Status LED	Platinum metallic	IR receiver decoder (industry standard)	5WG1287-2DB45	UP 287/45

Bus transceiver modules, Mounting depth 18 mm

UP 117/12

- For connection of a modular bus device to the bus line
- 10-pole BTI socket (BTI - Bus Transceiver Interface) for plugging of bus terminal devices with BTI connector
- For installation in flush-mounting switch and socket boxes with Ø 60 mm in diameter 40 mm deep
- Screw fixing
- Bus connection via bus terminal



Communication	KNX S-Mode KNX PL-Link
Dimensions (W x H x D)	71 x 71 x 18 mm

Stock No.

Product No.

5WG1117-2AB12

UP 117/12

IR remote, silver

S 425/72

IR hand-held transmitters:

- For wireless control of actuators via infrared signals, e.g. for switching on/off/toggle, dimming, send value, control solar protection or recall/save scenes
- 1 LED per group for control of transmission and battery
- Infrared wave length: 890 nm
- Infrared frequency: 455 kHz
- Transmission range: 20 m, non-directional
- Power supply by two commercially available 1.5 V batteries type Alkaline LR03/AAA



Communication	IR sender (industry standard)
Dimensions (W x H x D)	55 x 154 x 24 mm

Accessories for pushbuttons UP 223 and UP 287 with IR receiver decoder

Stock No.

Product No.

5WG1425-7AB72

S 425/72

AP 42../13



IR wall switch, titanium white

- For wireless control of actuators via infrared signals, e.g. for switching On/Off/Over, dimming, value transmission, shutter/blind control or call up/store scenes
- 1 LED for control of transmission and battery
- Red LED cover
- DIP switches for selection of the channel number (1...64)
- Infrared wave length: 890 nm
- Infrared frequency: 455 kHz
- Transmitter range: 8 m, non-directional
- Power supply by two commercially available 1.5 V batteries type Alkaline LR03/AAA
- Mounting frame for mounting on a flush-mounting wall box, on a wall surface or with adhesive tape on an even surface

Communication	IR sender (industry standard)
Color	Titanium white
Dimensions (W x H x D)	82 x 115 x 21 mm

Accessories for pushbuttons with IR receiver decoder have to be ordered separately, see chapter Gateways, Interface Converters - KNX infrared.

Range overview AP 42../13

Product Title	Stock No.	Product No.
IR wall switch, single, titanium white	5WG1420-3AB13	AP 420/13
IR wall switch, double, titanium white	5WG1421-3AB13	AP 421/13
IR wall switch, quadruple, titanium white	5WG1422-3AB13	AP 422/13

TX-I/O™ modules

Simple planning and executions:

- Slim, easy-to-understand I/O product range
- Highest flexibility for I/O point mix

Efficient panel construction:

- Small space requirements thanks to very compact construction
- DIN form eases panel construction using standard components
- Self-learning bus connections of the TX-I/O™ module with power supply
- Direct connection with interchangeable pins

Fast commissioning and service:

- Easiest possible addressing
- Fast servicing: plug-in I/O module exchange without tools or rewiring
- permute proof terminal bases

Operating voltage DC 22.5...26 V
 Dimensions (W x H x D) 64 x 77.5 x 98 mm

6 Relay output module, bistable

6 outputs signaled with green LED, without local operation.

6 DO (volt-free, bistable), individually configurable as:

- Switching of fluorescent lamps (number of ballasts see data sheet)
- Configurable behavior in case of power failure and bus failure
- Max. inrush current 800 A (20 µs), 165 A (20 ms)
- Switching voltage AC 24...277 V
- Switching current max. 10 A (cos φ = 0.8)

Data sheet N8177
 Operating voltage DC 22.5...26 V
 Power consumption 0.8 W
 Dimensions (W x H x D) 64 x 77.5 x 98 mm

TXM1.6RL



Stock No.	Product No.
S55661-J103	TXM1.6RL

6 Relay output module

6 outputs signaled with green LED, without local operation.

6 DO (relay switch), individually configurable as:

- Continuous or impulse contact
- Single-stage or multi-stage
- Three-point positioning output with internal stroke model
- Switching voltage AC 12...250 V / DC 12...30 V
- Switching current max. 4 A

Hardware bolting device is by means of external wiring the two-way contacts.

Data sheet N8175
 Operating voltage DC 22.5...26 V
 Power consumption 1.7 W
 Dimensions (W x H x D) 64 x 77.5 x 98 mm
 Weight 0.231 kg

TXM1.6R



Stock No.	Product No.
BPZ:TXM1.6R	TXM1.6R

TXM1.8D



8 Digital Input Module

8 digital input, signaling per input with three-colored LED (green, yellow, red), without local operation.

8 DI, individually configurable as:

- Message signal
- Message impulse with storage functions
- Counter impulse for up to a maximum of 10 Hertz

Data sheet	N8172
Operating voltage	DC 22.5...26 V
Power consumption	1.1 W
Dimensions (W x H x D)	64 x 77.5 x 98 mm
Weight	0.164 kg

Stock No. Product No.

BPZ:TXM1.8D **TXM1.8D**

TXM1.8RB



8 Relay output module for blinds control

8 relay outputs for blinds control, signaled with green LED, without local operation.

8 DO (non-floating):

- 4 blinds motors with 2 end switches
- 2 blinds motors with 3 end switches
- 2 blinds motors with 2 end switches + 1 blinds motor with 3 end switches
- Current measurement for each blinds motor
- Switching voltage AC 100... 250 V
- Switching current max. 3 A (motor)

Data sheet	N8178
Operating voltage	DC 22.5...26 V
Power consumption	1.4 W
Dimensions (W x H x D)	64 x 77.5 x 98 mm

Stock No. Product No.

S55661-J105 **TXM1.8RB**

TXM1.8T



8 Triac output module

8 Triac outputs, signaled with green LED.

8 AO, configurable for:

- Permanent contact
- Three-point positioning output with internal stroke model
- Pulsewidth-modulated output (PWM)
- Switching voltage AC 24 V
- Switching current AO 3-position: 250 mA / 6 VA per output
- Switching current AO PWM, BO: 125 mA / 3 VA per output

Data sheet	N8179
Operating voltage	DC 22.5...26 V
Power consumption	1.0 W
Dimensions (W x H x D)	64 x 77.5 x 98 mm

Stock No. Product No.

S55661-J106 **TXM1.8T**

16 Digital Input Module

TXM1.16D

16 digital input, signaling per input with green LED, without local operation.

16 DI, individually configurable as:

- Message signal
- Message impulse with storage functions
- 8 inputs as counter impulse for up to a maximum of 10 Hertz



Data sheet	N8172
Operating voltage	DC 22.5...26 V
Power consumption	1.4 W
Dimensions (W x H x D)	64 x 77.5 x 98 mm
Weight	0.199 kg

Stock No. Product No.

BPZ:TXM1.16D **TXM1.16D**

8 Universal I/O Module

TXM1.8U

8 inputs/outputs signaled with green LED, without local operation

8 universal I/O points, individually configurable as:

- DI: Message signal, message impulse or counter impulse (25 Hertz)
- AI: Temperature sensor or DC 0...10 V
- AO: DC 0...10 V



Data sheet	N8173
Operating voltage	DC 22.5...26 V
Power consumption	1.5 W
Dimensions (W x H x D)	64 x 77.5 x 98 mm
Weight	0.179 kg

Stock No. Product No.

BPZ:TXM1.8U **TXM1.8U**

Room automation
Desigo TRA
Accessories Desigo TX-I/O

TXA1.IBE



Island bus expansion module for decentralized sub-islands with TX-I/O-modules

- Expand island bus to a distance of up to 2 x 200 meters
- Compact design per DIN 43 880, requires little space
- With LED to monitor communication status
- Easy installation and setup:
 - Mounted on standard rails
 - Self-connecting bus (island bus) for the easiest possible installation
 - Plug-in screw terminals for island bus expansion
 - No programming / parameterization tool required

Data sheet N8184

Dimensions (W x H x D) 32 x 77.5 x 98 mm

Weight 0.064 kg

Stock No. Product No.

BPZ:TXA1.IBE TXA1.IBE

TXS1.12F10



TX-I/O Power Supply Modules 24 VDC Supply 1200 mA, 10 A Fuse

Up to 4 power supply modules can be operated in parallel
 AC 24 Volt input
 Generation / transfer of DC 24 V, 1.2A for the supply of TX-I/O modules and field devices
 Fresh provision of AC 24 V for field device supply
 Transfer of the bus signal

Data sheet N8183

Dimensions (W x H x D) 96 x 77.5 x 98 mm

Weight 0.309 kg

Stock No. Product No.

BPZ:TXS1.12F10 TXS1.12F10

TXS1.EF10



BUS Connection Module, 10A Fuse

Transfer of DC 24 V for the supply of TX-I/O modules and field devices
 Fresh provision of AC / DC 12 ... 24 V for field device supply
 Transfer of the bus signal

Data sheet N8183

Dimensions (W x H x D) 32 x 77.5 x 98 mm

Weight 0.082 kg

Stock No. Product No.

BPZ:TXS1.EF10 TXS1.EF10

Set of address plugs

Product Title	Data sheet	Stock No.	Product No.
Address Keys 1-12 + reset key	N8170	BPZ:TXA1.K12	TXA1.K12
Address Keys 1-24 + 2 reset keys	N8170	BPZ:TXA1.K24	TXA1.K24
Address keys 25-48 + 2 reset keys	N8170	BPZ:TXA1.K-48	TXA1.K-48
Address keys 49-72 + 2 reset keys	N8170	BPZ:TXA1.K-72	TXA1.K-72
Address keys 73-96 + 2 reset keys	N8170	S55661-J101	TXA1.K-96
Address keys 97-120 + 2 reset keys	N8170	S55661-J102	TXA1.K-120
Address key 5, 10 ... 120 + 2 reset keys	N8170	BPZ:TXA1.5K120	TXA1.5K120

Labeling material

Product Title	Data sheet	Stock No.	Product No.
Labels (sheet A4 with 9 labels)	N8170	BPZ:TXA1.LA4	TXA1.LA4
Spare transparent label holders (10 pcs.)	N8170	BPZ:TXA1.LH	TXA1.LH



RXM21.1



I/O block with KNX PL-Link block for use with a PXC3.E7.. series room automation station

The I/O block with KNX PL-Link, RXM21.1 contains the inputs and outputs required by a PXC3 series room automation station for a Fancoil application.

- KNX PL-Link bus communication
- Valve control (3 potential-free relay contacts)
- Thermal valve actuator control (AC 24 V)
- Motor-driven valve and damper actuators (AC 24 V, 2- or 3-point)
- Pluggable screw terminals

Data sheet	N3835
Operating voltage	AC 230 V
Frequency	50/60 Hz
Power consumption	12 VA
Digital inputs, number	2
Analog inputs, number	1
Triac outputs, number	4
Triac outputs	ON/OFF
Triac output, switching voltage	AC 24 V
Triac output, switching current	0.5 A
Relay outputs, number	3
Relay output, switching voltage	AC 250 V
Relay output, switching current	5 (4) A
Degree of protection	IP20
Communication	KNX PL-Link
Mounting	On DIN rail
Dimensions (W x H x D)	113 x 167 x 62 mm

Stock No.	Product No.
-----------	-------------

S55376-C104	RXM21.1
-------------	---------

RXM39.1



I/O block with KNX PL-Link for use with a PXC3.E7.. series room automation station

The I/O block with KNX PL-Link, RXM39.1 contains the inputs and outputs required by a PXC3 series room automation station for a fan-coil application.

- KNX PL-Link bus communication
- Fan control (ECM fan, DC 0...10 V)
- Actuator control DC 0...10 V
- Electric heating control DC 0...10 V
- Potential-free relay contacts to release fan and electric heating
- Plug-in screw terminals

Data sheet	N3836
Operating voltage	AC 230 V
Frequency	50/60 Hz
Power consumption	12 VA
Digital inputs, number	4
Analog inputs, number	2
Analog outputs, number	3
Analog output, signal	DC 0...10 V
Relay outputs, number	1
Electric reheater relay	1
Relay output, switching voltage	AC 250 V
Relay output, switching current	5 (4) A
Degree of protection	IP20
Communication	KNX PL-Link
Mounting	On DIN rail
Dimensions (W x H x D)	152 x 120 x 62 mm

Stock No. Product No.

S55376-C105 **RXM39.1**

Accessories for RXM..

Product Title	Data sheet	Stock No.	Product No.
Terminal cover for RXB../ RXL2../ RXC2../ RXM2..	N3834	BPZ:RXZ20.1	RXZ20.1
Terminal cover for RXB3.. / RXL3.. / RXC3../ RXM3..	N3840	BPZ:RXZ30.1	RXZ30.1

Room automation Desigo TRA Room control box with KNX PL-Link

RL 260/23



Binary Input, 4 inputs for AC/DC 12...230 V

- 4 Inputs for AC/DC 12...230 V
- Max. cable length, unshielded, twisted 100 m
- Screw-less terminals for connection and through-wiring of untreated single-core, stranded or multi-core conductors, 0.5 ... 2.5 mm²
- Bus-powered electronics
- Integrated bus coupling unit, bus connection via bus terminal
- For mounting in AP 118 automation module box or AP 641 room control box

Dimensions (W x H x D) 86.5 x 47.8 x 36.2 mm

Stock No. Product No.

5WG1260-4AB23 **RL 260/23**

UP 520/..3



Shutter actuators

- Electrically interlocked relays (drive protection)
- End position detection
- Screwless terminals for connection and through-wiring of untreated single-core, stranded or multi-core conductors, 0.5...2.5mm²
- Bus-powered electronics
- Integrated bus coupling units, bus connection via bus terminal
- For insertion in flush-mounting switch and socket boxes 60 mm in diameter and 60 mm deep

Product Title	Dimensions (W x H x D)	Stock No.	Product No.
Shutter Actuator with mounting frame and BTI socket	71 x 71 x 42 mm	5WG1520-2AB03	UP 520/03
Shutter Actuator without mounting frame	50 x 50.9 x 41.3 mm	5WG1520-2AB13	UP 520/13

RS 520/23



Shutter Actuator, 1 x 230 V AC, 6 A

- 1 channel
- For the separate control per actuator channel of a sun protection, damper, door or window drive with a motor for AC 230 V and electromechanical limit switches
- Electrically interlocked relays (for reversing direction of rotation)
- Screw-less terminals for connection and through-wiring of untreated single-core, stranded or multi-core conductors, 0.5 ... 2.5 mm²
- With bus connection module
- Bus-powered electronics
- Integrated bus coupling unit, bus connection via bus terminal
- Modular installation device for mounting in AP 118 automation module box or AP 641 room control box

Dimensions (W x H x D) 50.2 x 48.8 x 35.5 mm

Stock No. Product No.

5WG1520-2AB23 **RS 520/23**

Shutter Actuator, 2 x AC 230 V, 6 A

RL 521/23

- 2 channels
- For the separate control per actuator channel of a sun protection, damper, door or window drive with a motor for AC 230 V and electromechanical limit switches
- Electrically interlocked relays (for reversing direction of rotation)
- Screw-less terminals for connection and through-wiring of untreated single-core, stranded or multi-core conductors, 0.5 ... 2.5 mm²
- Bus-powered electronics
- Integrated bus coupling units, bus connection via bus terminal
- For mounting in AP 118 automation module box or AP 641 room control box



Dimensions (W x H x D) 86.5 x 47.8 x 36.2 mm

Stock No.	Product No.
5WG1521-4AB23	RL 521/23

Switching actuator, 1 x AC 230 V, C load

RL 512/23

- 1 floating relay contact
- Rated contact voltage, 230 V AC
- Rated contact current 16 AX / 20 A
- Configurable behavior in the event of a bus voltage failure/recovery
- Unchanged switching state of outputs in the event of system voltage failure
- Screw-less terminals for connection and through-wiring of untreated single-core, stranded or multi-core conductors, 0.5 ... 2.5 mm²
- Bus-powered electronics
- Integrated bus coupling unit, bus connection via bus terminal
- For mounting in AP 118 automation module box or AP 641 room control box



Dimensions (W x H x D) 86.5 x 47.8 x 36.2 mm

Stock No.	Product No.
5WG1512-4AB23	RL 512/23



Room automation

Desigo TRA

Room control box with KNX PL-Link

UP 510/..3



Binary Output

- Rated contact voltage 230 V AC
- 2 floating relay contacts
- Rated contact current 10 A
- Screwless terminals for connection and through-wiring of untreated single-core, stranded or multi-core conductors, 0.5...2.5mm²
- Bus-powered electronics
- Integrated bus coupling units, bus connection via bus terminal
- For insertion in flush-mounting switch and socket boxes 60 mm in diameter and 60 mm deep

Product Title	Dimensions (W x H x D)	Stock No.	Product No.
Binary Output, 2 x 230 V AC, 10A, 10-pole BTI socket for plugging of bus terminal devices and mounting frame	71 x 71 x 42 mm	5WG1510-2AB03	UP 510/03
Binary Output, 2 x 230 V AC, 10A, without mounting frame	50 x 50.9 x 41.3 mm	5WG1510-2AB13	UP 510/13

RS 510/23



Binary output devices, 2 x 230 V AC, 10 A (resistive load)

- 2 floating relay contacts
- Rated contact voltage AC 230 V
- Rated contact current 10 A
- Screw-less terminals for connection and through-wiring of untreated single-core, stranded or multi-core conductors, 0.5 ... 2.5 mm²
- With bus connection module
- Bus-powered electronics
- Integrated bus coupling unit, bus connection via bus terminal
- Modular installation device for mounting in AP 118 automation module box or AP 641 room control box

Dimensions (W x H x D)	50.2 x 48.8 x 35.5 mm	Stock No.	Product No.
		5WG1510-2AB23	RS 510/23

Binary output (relay), 3 x AC 230 V, 6 A

RL 513/23

- 3 floating relay contact
- One relay contact per output as switching element
- Rated contact operating voltage AC 230 V
- Rated contact frequency: 50/60 Hz
- Contact rated current according to DIN EN 60669-1: 6 A
- Screw-less terminals for connection and through-wiring of untreated single-core, stranded or multi-core conductors, 0.5...2.5 mm²
- Bus-powered electronics
- Integrated bus coupling unit, bus connection via bus terminal block
- For mounting in AP 118 automation module box or AP 641 room control box



Dimensions (W x H x D) 86.5 x 47.8 x 36.2 mm

Stock No.

Product No.

5WG1513-4DB23

RL 513/23

Universal Dimmer, (R,L,C load)

UP 525/..3

- One output for switching and dimming resistive, inductive or capacitive loads
- Automatic adjustment to leading edge or trailing edge control, depending on the type of load
- Rated operational voltage 230 V AC
- Rated frequency 50...60 Hz
- Rated power at +35°C ambient temperature: 10...250 VA
- Electronic protection of the output against overload, short circuit and temperature rise
- Screwless terminals for connection and through-wiring of untreated single-core, stranded or multi-core conductors, 0.5...2.5mm²
- Bus-powered electronics
- Integrated bus coupling units, bus connection via bus terminal
- For insertion in flush-mounting switch and socket boxes 60 mm in diameter and 60 mm deep



Product Title	Product Title	Stock No.	Product No.
Universal Dimmer, 1 x 230 V AC, 10 ... 250 VA, with mounting frame and BTI interface	71 x 71 x 42 mm	5WG1525-2AB03	UP 525/03
Universal Dimmer, 1 x 230 V AC, 10 ... 250 VA, without mounting frame	50 x 50.9 x 41.3 mm	5WG1525-2AB13	UP 525/13

Room automation

Desigo TRA

Room control box with KNX PL-Link

RS 525/23



Universal Dimmer, 1 x 230 V AC, 250 VA, (R,L,C load)

- One output for switching and dimming resistive, inductive or capacitive loads
- Automatic adjustment to leading edge or trailing edge control, depending on the type of load
- Rated operational voltage AC 230 V
- Rated frequency 50...60 Hz
- Rated power at +35°C ambient temperature: 10...250 VA
- Electronic protection of the output against overload, short circuit and temperature rise
- Reporting of overload, short circuit and temperature rise via the bus
- Screw-less terminals for connection and through-wiring of untreated single-core, stranded or multi-core conductors, 0.5 ... 2.5 mm²
- With bus connection module
- Bus-powered electronics
- Integrated bus coupling unit, bus connection via bus terminal
- Modular installation device for mounting in AP 118 automation module box or AP 641 room control box

Dimensions (W x H x D)

50.2 x 48.8 x 35.5 mm

Stock No.

Product No.

5WG1525-2AB23

RS 525/23

AP 118/01



Control Module Box, 1 slot for a sensor/actuator module, type RS or RL

- 1 slot for a sensor/actuator module, type RS or RL
- Separate connection compartment and strain relief for bus cable and functional lines
- Modular installation device with screw fixing for installation in linking ducts, under raised floors or for surface mounting on the ceiling
- Enclosure: Plastic
- Degree of protection: IP20

Dimensions (W x H x D)

180 x 50 x 41.1 mm

Stock No.

Product No.

5WG1118-4AB01

AP 118/01

AP 641/01



Room Control Box, 8 slots for a sensor/actuator module, type RS or RL

- 8 slots for a sensor/actuator module, type RS or RL
- Internal bus cable for connection of the sensor/actuator module to the bus
- Separate connection compartment and strain relief for functional lines
- Two PE/N bars for accommodation of the PE and neutral conductor of the functional lines
- Bus connection via bus terminal
- Modular installation device with screw fixing for installation under raised floors, on the wall or ceiling or in wet rooms
- Enclosure: Plastic
- Degree of protection: IP54

Dimensions (W x H x D)

300 x 300 x 50 mm

Stock No.

Product No.

5WG1641-3AB01

AP 641/01

Presence detector

UP 258D

Passive infrared detector for ceiling mounting indoors

- Optional blinding of parts of the detection area
- Mixed light measurement
- Power supply over the bus line
- Integrated bus coupling unit, bus connection via bus terminal
- Ceiling mounting on a flush-mounting box with 60 mm diameter and min. 40 mm depth or in a housing for surface-mounting (to be ordered separately)
- Integrated IR decoder for S 255/11

Dimension (Ø x H) 88 x 63 mm

Presence detector / Motion detector with brightness sensor

UP 258D11

- Monitoring range horizontal 360°, vertical approx. 100°
- Tilting sensor head
- Monitoring of an area of 6 x 3,5 m to mounting high 2,8 m



Stock No. Product No.

5WG1258-2DB11 UP 258D11

Presence detector with brightness sensor

UP 258D12

- Monitoring motion range horizontal 360°, vertical approx. 105°
- Monitoring motion of an area of diameter 8 m (depending on mounting/room height)
- UP mounting with fixing claws in suspended ceiling
- Programming button reachable from front



Stock No. Product No.

5WG1258-2DB12 UP 258D12

Brightness sensor with constant light level controller

UP 255D21

- Mixed light measurement
- Ceiling mounting on a flush-mounting box with 60 mm diameter and min. 40 mm depth or in a housing for surface-mounting (to be ordered separately)
- Programming button reachable from front
- Integrated IR decoder for S 255/11



Dimensions (Ø x H) 88 x 63 mm

Stock No. Product No.

5WG1255-2DB21 UP 255D21

NEW PRODUCT

G..B181.1E/KN



VAV compact controller KNX

- Networked compact controller with KNX capability for plants with variable or constant air volume flow
- Integrated, highly precise differential pressure sensor, damper actuator and digitally configurable air volume controller
- Nominal torque 5 or 10 Nm, air damper rotation angle mechanically adjustable between 0 and 90°
- Configurable as single device per room or for cascade control with pressure ratio 1:1, positive pressure, or negative pressure
- Prewired with a 0.9 m connecting cable and a 0.9 m KNX bus cable

Data sheet	N3547
Communication	KNX S-Mode KNX LTE-Mode KNX PL-Link
Angular rotation	90 °
Positioning time	150 s
Degree of protection	IP54
Dimensions (W x H x D)	71 x 158 x 61 mm

Range overview G..B181.1E/KN

Torque [Nm]	Operating voltage [V]	Air damper area [m ²]	Power consumption [VA]	Stock No.	Product No.
5	AC 24	0.8	3	S55499-D134	GDB181.1E/KN
10	AC 24	1.5	3	S55499-D135	GLB181.1E/KN

Basic Documentation No.: P3547



Room automation Desigo TRA Accessories for KNX PL-Link

N 125/..2



Power supply unit

- Integrated chokes
- Bus connection via bus terminal or contact system to data rail
- Rated operational voltage 120...230 V AC, 50...60 Hz, 220 V DC
- Output voltage 29 V DC
- Additional unchoked output for 29 V DC, for powering a second bus line via an external choke (e. g. N 120/02)
- Modular installation devices for mounting on TH35 EN 60715 mounting rail

Operating voltage	AC 120...230 V DC 220 V
Dimension width (1 MW = 18 mm)	4 MW
Bus connection	Integrated choke Via bus terminal Via data rail

Range overview N 125

Product Title	Stock No.	Product No.
Power supply unit DC 29 V, 160 mA with additional unchoked output, N 125/02	5WG1125-1AB02	N 125/02
Power supply unit DC 29 V, 320 mA with additional unchoked output, N 125/12	5WG1125-1AB12	N 125/12
Power supply unit DC 29 V, 640 mA with additional unchoked output, N 125/22	5WG1125-1AB22	N 125/22

The optional data rail must be ordered separately. See chapter System Products and Accessories - data rails.

OCI702



Service interface for USB / KNX

The service interface consists of:

- OCI702 service interface
- USB 2.0 cable (Type A / B)
- KNX service cable for Synco™ controllers (RJ45 / RJ45)
- KNX service cable for Desigo™ TRA (RJ45 / jack plug 2.5 mm)
- KNX service cable (RJ45 / KNX bus terminal)

With the respective PC software, the interfaces allows to commission and service devices with KNX communication, e.g. from the following ranges:

- Synco™ 700 controllers and room devices
- KNX room thermostats RDF..., RDG..., RDU341
- Individual room controllers RXB... / RXL...
- Synco™ living central apartment units QAX9...
- Desigo TRA
- GAMMA devices

Data sheet A6V10438951

	Stock No.	Product No.
	S55800-Y101	OCI702

RDG100KN



Room thermostat with KNX communications, AC 230 V, for fan coil units and universal applications

- KNX communications
- 3 multifunctional inputs for keycard contact, external room / return air temperature (QAH11.1, QAA32), heat / cool changeover, operation mode changeover, window contact on/off, dewpoint monitor, electrical heater enabled, fault contact
- Operating modes: Comfort, Economy and Protection
- 2-position, 3-position or PWM control outputs
- Automatic or manual fan speed for 1-speed, 3-speed fan
- Automatic or manual heating / cooling changeover
- Adjustable commissioning and control parameters
- Minimum and maximum setpoint limitation
- Backlit display

Application selectable:

- 2-pipe system
- 2-pipe system with electrical heater
- 2-pipe system and radiator / floor heating
- 4-pipe system
- 4-pipe system with electrical heater
- 2-stage heating or cooling system

Data sheet	N3191
Operating voltage	AC 230 V
Switching differential	Heating: 0.5...6 K Cooling: 0.5...6 K
Setpoint setting range	5...40 °C
Analog inputs, number	2
Digital inputs, number	1
Relay outputs, number	3
Relay outputs	Fan: 1- or 3-speed
Relay output, switching voltage	AC 230 V
Relay output, switching current	5 (4) A
Triac outputs, number	3
Triac outputs	Valve, el. heater 2-position, PWM, 3-position
Triac output, switching voltage	AC 230 V
Triac output, switching current	Max. 1 A
Type of fixing	Wall mounting with screws
Degree of protection	IP30
Dimensions (W x H x D)	93 x 128 x 30.8 mm
Communication	Bus: KNX (S-Mode und LTE-Mode mit Synco 700)

Stock No. Product No.

S55770-T163

RDG100KN



Room automation

Desigo RX

Communicating room thermostats

RDG160KN



Room thermostat with KNX communications, AC 24 V, for fan coil units and universal applications, heat pump, fan (1-/3-speed, DC), valves (2-point, DC)

- KNX communications
- For applications with DC control outputs and DC or 3-speed fan output
- For applications with 2-position control output with DC fan output
- 3 multifunctional inputs for keycard contact, external room / return air temperature (QAH11.1, QAA32), heat / cool changeover, operation mode changeover, window contact on/off, dewpoint monitor, electrical heater enabled, fault contact
- Operating modes: Comfort, Economy and Protection
- Automatic or manual EC fan or 1-/3-speed
- Automatic or manual heating / cooling changeover
- Adjustable commissioning and control parameters
- Minimum and maximum setpoint limitation
- Backlit display

Application selectable:

- 2-pipe system
- 2-pipe system with electrical heater
- 2-pipe system and radiator / floor heating
- 4-pipe system
- 2-stage heating or cooling system

Data sheet	N3191
Operating voltage	AC 24 V
Switching differential	Heating: 0.5...6 K Cooling: 0.5...6 K
Setpoint setting range	5...40 °C
Analog inputs, number	2
Digital inputs, number	1
Relay outputs, number	3
Relay outputs	Valve, compressor or el. heater: 2 outputs, 2-position Fan: 1- or 3-speed
Relay output, switching voltage	AC 24...230 V
Relay output, switching current	5 (4) A
Analog outputs, number	3
Analog outputs	Valve, el. heater: 2 Fan: 1 (ECM)
Analog output, signal	DC 0...10 V
Type of fixing	Wall mounting with screws
Degree of protection	IP30
Dimensions (W x H x D)	93 x 128 x 30.8 mm
Communication	Bus: KNX (S-Mode und LTE-Mode mit Synco 700)

Stock No. Product No.

S55770-T297

RDG160KN

Touch screen room thermostat with KNX communications, for 2-/4- pipe fan coil, universal applications or compressors in DX-type equipment

RDF800KN



Touch screen room thermostat for 2-/4-pipe fan coil, universal applications or compressors in DX-type equipment

- KNX communications
- Operating modes: Comfort, Economy and Protection
- For heating and/or cooling applications
- 2 or 3-position control outputs
- Output for 1-speed or 3-speed fan
- 2 multifunctional inputs for keycard contact, external room / return air temperature (QAH11.1, QAA32), heat / cool changeover, window contact on/off, dewpoint monitor, electrical heater enabled, fault contact, presence detector
- Automatic or manual heating/cooling changeover
- Adjustable commissioning and control parameters
- Minimum and maximum setpoint limitation
- Color of housing: Ivory white
- Backlit display

Application selectable:

- 2-pipe system
- 2-pipe system with electrical heater
- 4-pipe system

Data sheet	N3174
Operating voltage	AC 230 V
Switching differential	0.5...6 K
Setpoint setting range	5...40 °C
Analog inputs, number	2
Relay outputs, number	5
Relay outputs	Fan: N.O. contacts, non-floating Valve: N.O. contacts, non-floating
Relay output, switching voltage	AC 230 V
Relay output, switching current	5 (2) A
Type of fixing	With screws on recessed round conduit box diameter min. 60 mm
Degree of protection	IP30
Dimensions (W x H x D)	86 x 86 x 47 mm
Communication	Bus: KNX (S-mode and LTE mode with Synco 700)

Stock No. Product No.

S55770-T350

RDF800KN

RDF..KNX Flush Mount



Flush-mount room thermostats with KNX communications, 2-/4-pipe fan coils or DX type equipment

Flush-mount room thermostat with LCD for fan coil units and compressors in DX-type equipment

- KNX communications
- Operating modes: Comfort, Economy and Protection
- For heating and/or cooling applications
- 2 or 3-position control outputs
- Output for 1-speed or 3-speed fan
- 2 multifunctional inputs for keycard contact, external room / return air temperature (QAH11.1, QAA32), heat / cool changeover, operation mode changeover, window contact on/off, dewpoint monitor, electrical heater enabled, fault contact
- Automatic or manual heating/cooling changeover
- Adjustable commissioning and control parameters
- Minimum and maximum setpoint limitation
- Color of housing: signal white (RAL 9003)
- Backlit display

Application selectable:

- 2-pipe system
- 2-pipe system with electrical heater
- 4-pipe system

Data sheet	N3171
Operating voltage	AC 230 V
Setpoint setting range	5...40 °C
Analog inputs, number	2
Relay outputs, number	5
Relay outputs	Fan: N.O. contacts, non-floating Valve: N.O. contacts, non-floating
Relay output, switching voltage	AC 230 V
Relay output, switching current	5 (2) A
Degree of protection	IP30
Communication	Bus: KNX (S-mode and LTE mode with Synco 700)

Range overview RDF..KNX Flush Mount

Product Title	Type of fixing	Dimensions (W x H x D) [mm]	Stock No.	Product No.
Flush-mount room thermostat with KNX communications, 2-/4-pipe fan coils or DX type equipment	With screws on recessed round conduit box diameter min. 60 mm	86 x 86 x 46	S55770-T293	RDF600KN
Flush-mount room thermostat with KNX communications, 2-/4-pipe fan coils or DX type equipment	Recessed rectangular conduit box BS4662 with fixing centres of 60.3 mm (ARG71)	86 x 86 x 57	S55770-T104	RDF301
Flush-mount room thermostat with KNX communications, 2-/4-pipe fan coils or DX type equipment, four buttons for switching lights and blinds	Recessed rectangular conduit box BS4662 with fixing centres of 60.3 mm (ARG71)	86 x 86 x 57	S55770-T105	RDF301.50
Hotel Flush-mount room thermostat with KNX, 2-/4-pipe fan coils or DX type equipment, four buttons hotel functions	Recessed rectangular conduit box BS4662 with fixing centres of 60.3 mm (ARG71)	86 x 86 x 57	S55770-T334	RDF301.50H

RDG400KN



Room thermostat with KNX communications, AC 24 V, VAV heating and cooling systems

- KNX communications
- Output DC 0...10 V for VAV actuator and auxiliary output ON/OFF, PWM or 3-position or 3-position for VAV actuator and auxiliary output DC 0...10 V
- 2 multifunctional inputs for keycard contact, external room / return air temperature (1x, QAH11.1, QAA32), heat / cool changeover, operation mode changeover, window contact on/off, dewpoint monitor, electrical heater enabled, fault contact
- 1 input DC 0...10 V for damper position feedback
- Operating modes: Comfort, Economy and Protection
- Modulating PI control
- Control depending on the room or the return air temperature
- Automatic or manual heating / cooling changeover
- Adjustable commissioning and control parameters
- Minimum and maximum setpoint limitation
- Minimum and maximum limitation of air flow signal
- Output signal inversion (DC 0...10 V) as an option
- Backlit display

Application selectable:

- Single-duct system
- Single-duct system with electrical heater
- Single-duct system and radiator / floor heating
- Single-duct system with heating / cooling coil

Data sheet	N3192
Operating voltage	AC 24 V
Setpoint setting range	5...40 °C
Analog inputs, number	2
Analog input, signal	NTC 3k DC 0...10 V
Digital inputs, number	1
Analog outputs, number	1
Analog outputs	VAV actuator, electric heater, valve
Analog output, signal	DC 0...10 V
Analog output, current	Max. ±1 mA
Triac outputs, number	1
Triac outputs	VAV actuator, valve, el. heater 2-position, PWM, 3-position
Triac output, switching voltage	AC 24 V
Triac output, switching current	Max. 1 A
Type of fixing	Wall mounting with screws
Degree of protection	IP30
Dimensions (W x H x D)	93 x 128 x 30.8 mm
Communication	Bus: KNX (S-mode and LTE mode with Synco 700)

Stock No.	Product No.
S55770-T165	RDG400KN

Room automation

Desigo RX

Communicating room thermostats

RDU341



Semi Flush-mount room thermostat for rectangular conduit box with KNX communications, for VAV application

Semi Flush-mount room thermostat for VAV application

- KNX communications
- Output for a DC 0...10 V actuator and AC 230V electrical heater (ON-OFF)
- 2 multifunctional inputs for keycard contact, external room / return air temperature (QAH11.1, QAA32), heat / cool changeover, operation mode changeover, window contact on/off, dewpoint monitor, electrical heater enabled, fault contact
- Operating modes: Comfort, Economy and Protection
- Modulating PI control
- Control depending on the room or the return air temperature
- Automatic or manual heating/cooling changeover
- Adjustable commissioning and control parameters
- Minimum and maximum setpoint limitation
- Adjustable minimum and maximum limitation for air flow signal DC 0...10V
- Output signal inversion as an option

Application selectable:

- Single-duct system
- Single-duct system with electrical heater

Data sheet	N3172
Operating voltage	AC 24 V
Setpoint setting range	5...40 °C
Analog inputs, number	2
Analog outputs, number	1
Analog output, signal	DC 0...10 V
Analog output, current	Max. ±1 mA
Relay outputs, number	1
Relay outputs	N.O. contact, potential-free
Relay output, switching voltage	AC 230 V
Relay output, switching current	Max. 5 (2) A
Type of fixing	Recessed rectangular conduit box BS4662 (ARG71) with fixing centres of 60.3 mm
Dimensions (W x H x D)	86 x 86 x 57 mm
Communication	Bus: KNX (S-mode and LTE mode with Synco 700)

Stock No. Product No.

S55770-T106

RDU341

RXB2..



4

Room controller with KNX communication

The controllers are used for temperature control in individual rooms.

- For 2-pipe with changeover or 4-pipe fan coil systems
- For radiator and chilled ceiling (RXB24.1 only)
- Control of thermal valve actuators AC 24 V, PDM, valve and damper actuators AC 24 V (3-position) as well as KNX bus actuators
- Potential-free relay contacts for fan speed control
- Connecting relay for electric heating (RXB22.1 und RXB39.1)
- KNX bus communication
- Connection to Desigo building automation and control system via PX KNX
- Commissioning with "Handy Tool" QAX34.3 or Synco ACS

Application description fan coil: CM110672

Application description RAD/CLC: CM110671

Operating voltage	AC 230 V
Frequency	50/60 Hz
Power consumption	Max. 12 VA
Control algorithm	PI
Digital inputs, number	2
Triac outputs	PWM 3-position
Triac output, switching voltage	AC 24 V
Triac output, switching current	0.5 A
Relay output, switching voltage	AC 250 V
Relay output, switching current	5 (4) A
Communication	Bus: KNX (S-mode and LTE mode) Room unit: PPS2
Service plug	RXT20.1
Mounting location	Ceiling voids with cover Fan coil Panel
Mounting	On DIN rail With screws
Dimensions (W x H x D)	113 x 167 x 62 mm

Range overview RXB2..

Product Title	Triac outputs, number	Relay outputs, number	Data sheet	Stock No.	Product No.
Room controller for 3-speed fan	4	3	N3873	BPZ:RXB21.1/FC-10	RXB21.1/FC-10
Room controller for 3-speed fan	4	3	N3873	BPZ:RXB21.1/FC-11	RXB21.1/FC-11
Room controller with 3-speed fan and electric heating coil	2	4	N3873	BPZ:RXB22.1/FC-12	RXB22.1/FC-12
Room controller for chilled ceilings and radiators	4	0	N3874	BPZ:RXB24.1/CC-02	RXB24.1/CC-02

The application determines the usable actuator (PWM /3-position) with the triac output

RXB39.1/FC-13



Room controller for fan-coil applications with KNX communication

The RXB39.1 room controller is used for temperature control in individual rooms.

- For 2-pipe and 4-pipe fan coil systems with or without changeover
- PI control
- KNX bus communication
- Connection to Desigo building automation and control system via PX KNX
- DC 0...10 V control of valve and actuators, fan (ECM), and electric heater
- 2 Potential-free relay contacts to release fan and electric heating
- Commissioning with ETS Professional, "Handy Tool" QAX34.3 or Synco ACS
- Operating voltage AC 230 V
- Plug-in screw terminals

Data sheet	N3875
Operating voltage	AC 230 V
Frequency	50/60 Hz
Power consumption	12 VA
Control algorithm	PI
Digital inputs, number	4
Digital outputs, number	0
Analog inputs, number	2
Analog outputs, number	3
Relay output, switching voltage	AC 250 V
Relay output, switching current	5 (4) A
Degree of protection	IP20
Communication	Bus: KNX Room unit: PPS2
Service plug	ETS Professional, ACS, HandyTool
Mounting	On DIN rail
Dimensions (W x H x D)	152 x 120 x 62 mm

Stock No. Product No.

S55373-C121 **RXB39.1/FC-13**

Accessories for RXB..

Product Title	Data sheet	Stock No.	Product No.
Power amplifier for thermal actuators AC 24 V, PWM	N3591	BPZ:UA1T	UA1T
Terminal cover for RXB../RXL../RXC../RXM2..	N3834	BPZ:RXZ20.1	RXZ20.1
Terminal cover for RXB3../RXL3../RXC3../RXM3..	N3840	BPZ:RXZ30.1	RXZ30.1
Power supply unit DC 29 V, 160 mA with additional unchoked output, N 125/02	2.14.4.4	5WG1125-1AB02	N 125/02
Power supply unit DC 29 V, 320 mA with additional unchoked output, N 125/12	2.14.4.4	5WG1125-1AB12	N 125/12
Power supply unit DC 29 V, 640 mA with additional unchoked output, N 125/22	2.14.4.4	5WG1125-1AB22	N 125/22

Room units for RXB..

Product Title	Data sheet	Stock No.	Product No.
Room unit with sensor and PPS2 interface	N1741	BPZ:QAX30.1	QAX30.1
Room unit with sensor, setpoint adjuster and PPS2 interface	N1741	BPZ:QAX31.1	QAX31.1
Room unit with sensor, setpoint and operating mode selector and PPS2 interface	N1641	BPZ:QAX32.1	QAX32.1
Room unit with sensor, setpoint and operating mode selector, fan speed selection, and PPS2 interface	N1642	BPZ:QAX33.1	QAX33.1
Room unit with sensor, setpoint and operating mode selector, display and PPS2 interface	N1645	BPZ:QAX34.1	QAX34.1
Room unit with sensor, setpoint and operating mode selector, display and PPS2 interface	N1640	BPZ:QAX34.3	QAX34.3
Flush-mounted room unit complete with PPS2 interface and design frame	N1649	BPZ:QAX84.1/PPS2	QAX84.1/PPS2
Room unit with EnOcean interface	N1663	S55623-H104	QAX95.4
Room unit with EnOcean interface, setpoint adjuster	N1663	S55623-H105	QAX96.4
Room unit with EnOcean interface, setpoint adjuster, button and switch	N1663	S55623-H106	QAX97.4
Room unit with EnOcean interface, setpoint adjuster, button and switch for fan stages	N1663	S55623-H107	QAX98.4
Radio frequency receiver with Gateway EnOcean/KNX	N1662	S55842-Z101	RXZ97.1/KNX
Universal setpoint adjuster with PPS2 interface	N1646	BPZ:QAX39.1	QAX39.1

Temperature sensors for RXB..

Product Title	Data sheet	Stock No.	Product No.
Room temperature sensor LG-Ni1000	N1721	BPZ:QAA24	QAA24
Front module with passiv temperature measurement, LG-Ni1000	N1408	S55720-S133	AQR2531ANW
Room temperature sensor LG-Ni1000 for mounting on recessed conduit boxes	N1722	BPZ:QAA64	QAA64
Cable temperature sensor PVC 2 m, LG-Ni1000	N1831	BPZ:QAP22	QAP22
Duct temperature sensor 400 mm, LG-Ni1000	N1761	BPZ:QAM2120.040	QAM2120.040

For the complete flush mounting sensor offering including mounting plates and frames, see product catalog chapter 6

Dewpoint sensors for RXB..

Product Title	Data sheet	Stock No.	Product No.
Condensation monitor, AC/DC 24 V	N3302	S55770-T325	QXA2601
Condensation monitor, AC/DC 24 V, with remote sensor head (cable length 1.5 m)	N3302	S55770-T326	QXA2602
Condensation monitor, AC 230 V	N3302	S55770-T327	QXA2603
Condensation monitor, AC 230 V, with remote sensor head (cable length 1.5 m)	N3302	S55770-T328	QXA2604

Valve actuators for RXB..

Product Title	Data sheet	Stock No.	Product No.
Electrothermal actuator, AC/DC 24 V, NC, 2P, PDM, PR	N4884	S55174-A115	STA73PR/00
Electrothermal actuator, AC/DC 24 V, NO, 2P, PDM, PR	N4884	S55174-A116	STP73PR/00
Electromotoric actuator, 100 N, 2.5/5 mm, 1.5 m, AC 24 V, 3P	N4893	BPZ:SSA81	SSA81
Electromotoric actuator, 200 N, 5.5 mm, AC 24 V, 1.5 m, 3P	N4891	BPZ:SSB81	SSB81
Electromotoric actuator, 160 N, 2.5 mm, 1.5 m, AC 24 V, 3P	N4864	BPZ:SSP81	SSP81

For suitable combination of actuator STA.. and connection cable ASY.., see chapter introduction page 7-4 of the HVAC Catalog

Damper actuators for RXB..

Product Title	Data sheet	Stock No.	Product No.
Rotary air damper actuators 5 Nm, without spring return	N4634	BPZ:GDB..1E	GDB..1E
Linear air damper actuators 125 N, without spring return	N4664	BPZ:GDB..2E	GDB..2E
Rotary air damper actuators 10 Nm, without spring return	N4634	BPZ:GLB..1E	GLB..1E
Linear air damper actuators 250 N, without spring return	N4664	BPZ:GLB..2E	GLB..2E

Interfaces and tools RXB..

Product Title	Data sheet	Stock No.	Product No.
Service unit with LCD	N3851	BPZ:RXT20.1	RXT20.1
Room unit with sensor, setpoint and operating mode selector, display and PPS2 interface	N1640	BPZ:QAX34.3	QAX34.3

Connection to Desigo

Connection of RXB room controllers and thermostats with KNX communication.

Product Title	Data sheet	Stock No.	Product No.
System controller for the integration of KNX, M-Bus, Modbus or SCL over BACnet/LonTalk	N9223	S55372-C113	PXC001.D
System controller for the integration of KNX, M-Bus, Modbus or SCL over BACnet/IP	N9223	S55372-C114	PXC001-E.D

Connection to Synco 700

Connection of RXB room controllers and thermostats with KNX communication.

Product Title	Data sheet	Stock No.	Product No.
Central control unit RMB795B for room controllers and room thermostats	N3122	BPZ:RMB795B..	RMB795B..

Radiator, chilled ceilings and VAV room controllers with LonWorks communication

RXC10.5/..



The RXC10.5 controller is used for temperature control in individual rooms.

- For chilled ceilings and radiators
- VAV
- PID control
- Loadable application software
- LonMark-compatible bus communications
- Connection to Desigo building automation and control system
- Control of thermal valve actuators, AC 24 V, PDM*
- Operating voltage AC 24 V

* PDM = pulse duration modulation

Data sheet	N3830
Operating voltage	AC 24 V
Frequency	50/60 Hz
Power consumption	2 VA
Control algorithm	PI
Digital inputs, number	2
Position feedback	DC 0...10 V
Triac outputs, number	2
Triac outputs	ON/OFF
Triac output, switching voltage	AC 24 V
Triac output, switching current	0.5 A
Communication	Bus: LonWorks
Service plug	RXT10.., RXT20.1
Mounting location	In room
Dimensions (W x H x D)	92 x 126 x 40 mm

Range overview RXC10.5/..

Product Title	Stock No.	Product No.
Radiator, chilled ceilings and VAV room controller with LonWorks communication and basic application 00010	S55373-C110	RXC10.5/00010

The application determines the usable actuator (2-position /3-position) with the triac output

Accessories for RXC1..

Product Title	Data sheet	Stock No.	Product No.
Power amplifier for thermal actuators AC 24 V, PWM	N3591	BPZ:UA1T	UA1T

RXC20/21/22..

Room controller with LonWorks communication



- The RXC20.., RXC21.. and RXC22.. controllers are used for temperature control in individual rooms.
- For 2- or 4-pipe fan coil systems with or without changeover
 - For chilled ceilings and radiators
 - Control of thermic valve actuators AC 24 V, PDM, valve and damper actuators AC 24 V (3-position) or electric air heater units
 - Volt-free relay contacts for fan speed control
 - Connection to Desigo building automation and control system
 - LonMark-compatible bus communication
 - Plug-in screw terminal

Application description: CA110300

Data sheet	N3834
Operating voltage	AC 230 V
Frequency	50/60 Hz
Power consumption	12 VA
Control algorithm	PI
Digital inputs, number	2
Triac outputs	ON/OFF
Triac output, switching voltage	AC 24 V
Triac output, switching current	0.5 A
Relay output, switching voltage	AC 250 V
Relay output, switching current	5 (4) A
Communication	Bus: LonWorks Room unit: PPS2
Service plug	RXT10.., RXT20.1
Mounting location	Ceiling voids with cover Fan coil Panel
Mounting	On DIN rail With screws
Dimensions (W x H x D)	113 x 167 x 62 mm

Range overview RXC20/21/22..

Product Title	Triac outputs, number	Relay outputs, number	Electric reheater relay	Stock No.	Product No.
Room controller for fan coils with 1-speed fan or chilled ceiling/radiator with basic application OOO20	2	1	0	S55373-C111	RXC20.5/00020
Room controller for fan coils with 3-speed fan and/or outside air damper with basic application OOO21	4	3	0	S55373-C112	RXC21.5/00021
Room controller for fan coils with 3-speed fan and electric reheater with basic application OOO22	2	4	1	S55373-C113	RXC22.5/00022

The application determines the usable actuator (2-position/3-position) with the triac output

Accessories for RXC2..

Product Title	Data sheet	Stock No.	Product No.
Terminal cover for RXB../ RXL2../ RXC2../ RXM2..	N3834	BPZ:RXZ20.1	RXZ20.1
Power amplifier for thermal actuators AC 24 V, PWM	N3591	BPZ:UA1T	UA1T

Communicating room controller, with LonMark compatible bus communication

RXC39.5/00039

The RXC39.5 room controller is used for temperature control in individual rooms.

- For fan coil systems with continuous (ECM) fan
- Downloadable application software
- LonMark-compatible bus communication
- Connection to Desigo building automation and control system
- DC 0...10 V control of valve and damper actuators, fan, and electric heater
- Commissioning with RXT10 or standard LonWorks tool
- Operating voltage AC 24 V
- Plug-in screw terminals



Data sheet	N3856
Operating voltage	AC 24 V
Frequency	50/60 Hz
Power consumption	33 VA
Control algorithm	PI
Digital inputs, number	4
Digital outputs, number	0
Analog inputs, number	1
Analog outputs, number	4
Triac outputs	ON/OFF
Triac output, switching voltage	AC 24 V
Triac output, switching current	0.5 A
Relay output, switching voltage	AC 250 V
Relay output, switching current	2 (2) A
Communication	Bus: LonWorks Room unit: PPS2
Service plug	RXT10; Standard-LonWorks-Tool
Mounting location	Ceiling voids with cover Fan coil Panel
Mounting	On DIN rail
Dimensions (W x H x D)	152 x 120 x 62 mm

	Stock No.	Product No.
	S55373-C118	RXC39.5/00039

Accessories for RXC39..

Product Title	Data sheet	Stock No.	Product No.
Terminal cover for RXB3.. / RXL3.. / RXC3../ RXM3..	N3840	BPZ:RXZ30.1	RXZ30.1
Power amplifier for thermal actuators AC 24 V, PWM	N3591	BPZ:UA1T	UA1T

RXC30.5/..



Radiators, chilled ceilings, lighting, base module with LonWorks communication

The controllers are used for temperature and lighting control in individual rooms.

- PID control of chilled ceilings and radiators
- Extension modules for control of lighting and blinds
- Connection to Desigo building automation and control system
- LonMark-compatible bus communication
- Control of 2 thermic valve actuators AC 24 V (PDM) or 1 motorized valve actuator AC 24 V (3-position)
- Volt-free relay contacts for lighting control (16 A)
- Plug-in screw terminal

Data sheet	N3840
Operating voltage	AC 230 V
Frequency	50/60 Hz
Power consumption	12 VA
Control algorithm	PI
Digital input, application	HVAC Light
Triac outputs	HVAC: ON/OFF
Triac output, switching voltage	AC 24 V
Triac output, switching current	0.5 A
Relay output, switching voltage	AC 250 V
Relay output, switching current	16 (12) A
Communication	Bus: LonWorks Room unit: PPS2
Service plug	RXT10.., RXT20.1
Mounting location	Ceiling voids with cover Panel
Mounting	On DIN rail With screws
Dimensions (W x H x D)	152 x 120 x 62 mm

Range overview RXC30.5/..

Product Title	Stock No.	Product No.
Radiators, chilled ceilings, lighting, base module with LonWorks communication, basic application 00030	S55373-C114	RXC30.5/00030

The application determines the usable actuator (2-position /3-position) with the triac output

Extension modules and accessories for RXC30..

Product Title	Data sheet	Stock No.	Product No.
Extension module for lighting control	N3842	S55373-C119	RXC40.5
Extension module for blinds control	N3843	S55373-C120	RXC41.5
Terminal cover for RXB3.. / RXL3.. / RXC3../ RXM3..	N3840	BPZ:RXZ30.1	RXZ30.1
Power amplifier for thermal actuators AC 24 V, PWM	N3591	BPZ:UA1T	UA1T

VAV base module with LonWorks communication

RXC31.5/..



The RXC31.5 controller is used for VAV room temperature control in individual rooms.

- Control of supply and extract air, with volume control dampers or additional VAV compact controllers, with or without reheater
- Can be combined with extension modules for control of lighting and blinds
- Downloadable application software
- LonMark-compatible bus communication
- Connection to Desigo building automation and control system
- Control of damper actuators with AC 24 V, 3-position or DC 0...10 V positioning signal
- Control of VAV compact controllers (with differential pressure sensor, volumetric flow controller and actuator) with DC 0...10 V signal
- Control of electric or LPHW reheaters with AC 24 V or AC 24 V 3-position signals
- Operating voltage AC 24 V
- Plug-in screw terminal

Data sheet	N3844
Operating voltage	AC 24 V
Frequency	50/60 Hz
Power consumption	33 VA
Control algorithm	PI
Digital inputs, number	3
Analog inputs, number	3
Triac outputs	ON/OFF
Position feedback	DC 0...10 V
Mounting	On DIN rail With screws
Communication	Bus: LonWorks Room unit: PPS2
Service plug	RXT10.., RXT20.1
Mounting location	Ceiling voids with cover Panel VAV box
Dimensions (W x H x D)	152 x 120 x 62 mm

Range overview RXC31.5/..

Product Title	Stock No.	Product No.
VAV base module with LonWorks communication, basic application 00031	S55373-C115	RXC31.5/00031

The application determines the usable actuator (2-position /3-position) with the triac output

Accessories for RXC31..

Product Title	Data sheet	Stock No.	Product No.
Extension module for lighting control	N3842	S55373-C119	RXC40.5
Extension module for blinds control	N3843	S55373-C120	RXC41.5
Terminal cover for RXB3.. / RXL3.. / RXC3.. / RXM3..	N3840	BPZ:RXZ30.1	RXZ30.1
Power amplifier for thermal actuators AC 24 V, PWM	N3591	BPZ:UA1T	UA1T

RXC32.5/..



VAV room controller with LonWorks communication

- The RXC32.5 controller is used for VAV room temperature control in individual rooms.
- Control of the supply or extract air with volume control dampers, with or without reheater
 - Downloadable application software
 - LonMark-compatible bus communication
 - Connection to Desigo building automation and control system
 - Control of damper actuators with AC 24 V, 3-position positioning signal
 - Control of electric or LPHW reheaters with AC 24 V or AC 24 V 3-position signals
 - Built-in air flow sensor
 - Operating voltage AC 24 V
 - Plug-in screw terminal

Data sheet	N3845
Operating voltage	AC 24 V
Frequency	50/60 Hz
Power consumption	33 VA
Control algorithm	PI
Digital inputs, number	2
Triac outputs	ON/OFF
Triac output, switching voltage	AC 24 V
Triac output, switching current	0.5 A
Communication	Bus: LonWorks Room unit: PPS2
Service plug	RXT10.., RXT20.1
Mounting location	Ceiling voids with cover Panel VAV box
Mounting	On DIN rail With screws
Dimensions (W x H x D)	152 x 120 x 62 mm

Range overview RXC32.5/..

Product Title	Stock No.	Product No.
VAV room controller with LonWorks communication, basic application 00032	S55373-C116	RXC32.5/00032

The application determines the usable actuator (2-position /3-position) with the triac output

Accessories for RXC32..

Product Title	Data sheet	Stock No.	Product No.
Terminal cover for RXB3.. / RXL3.. / RXC3.. / RXM3..	N3840	BPZ:RXZ30.1	RXZ30.1
Power amplifier for thermal actuators AC 24 V, PWM	N3591	BPZ:UA1T	UA1T

Extension module for lighting control

RXC40.5

- Switching and dimming of 2 groups of lights



Data sheet	N3842
Voltage supply	From base module
Digital inputs, number	4
Relay output, switching voltage	AC 250 V
Relay output, switching current	12 (12) A
Analog outputs, number	2
Interface for base module	PE-bus for RXC3..
Mounting location	Ceiling voids with cover Panel
Mounting	On DIN rail
Dimensions (W x H x D)	80 x 120 x 62 mm

Stock No.	Product No.
S55373-C119	RXC40.5

Extension module for blinds control

RXC41.5

- Control of 2 electric motors for blinds



Data sheet	N3843
Voltage supply	From base module
Digital inputs, number	4
Relay output, switching voltage	AC 250 V
Relay output, switching current	3 (3) A
Interface for base module	PE-bus for RXC3..
Mounting location	Ceiling voids with cover Panel
Mounting	On DIN rail
Dimensions (W x H x D)	80 x 120 x 62 mm

Stock No.	Product No.
S55373-C120	RXC41.5

Accessories for RXC40.. and RXC41..

Product Title	Data sheet	Stock No.	Product No.
Terminal cover for RXC4.. and AQX2000	N3842	BPZ:RXZ40.1	RXZ40.1

Connection to Desigo

Product Title	Data sheet	Stock No.	Product No.
System controller BACnet/LonTalk	N9222	BPZ:PXC00.D	PXC00.D
System controller BACnet/IP	N9222	BPZ:PXC00-E.D	PXC00-E.D
Automation station BACnet/LonTalk, with up to 52 data points	N9222	S55372-C109	PXC50.D
Automation station BACnet/IP, with up to 52 data points	N9222	S55372-C110	PXC50-E.D
Automation station BACnet/LonTalk, with up to 200 data points	N9222	BPZ:PXC100.D	PXC100.D
Automation station BACnet/IP, with up to 200 data points	N9222	BPZ:PXC100-E.D	PXC100-E.D
Automation station BACnet/LonTalk, with more than 200 data points	N9222	BPZ:PXC200.D	PXC200.D
Automation station BACnet/IP, with more than 200 data points	N9222	BPZ:PXC200-E.D	PXC200-E.D
Extension module for up to 60 LonWorks devices / RXC room controllers	N9282	BPZ:PXX-L11	PXX-L11
Extension module for up to 120 LonWorks devices / RXC room controllers	N9282	BPZ:PXX-L12	PXX-L12

Room units for RXC..

Product Title	Data sheet	Stock No.	Product No.
Room unit with sensor and PPS2 interface	N1741	BPZ:QAX30.1	QAX30.1
Room unit with sensor, setpoint adjuster and PPS2 interface	N1741	BPZ:QAX31.1	QAX31.1
Room unit with sensor, setpoint and operating mode selector and PPS2 interface	N1641	BPZ:QAX32.1	QAX32.1
Room unit with sensor, setpoint and operating mode selector, fan speed selection, and PPS2 interface	N1642	BPZ:QAX33.1	QAX33.1
Room unit with sensor, setpoint and operating mode selector, display and PPS2 interface	N1645	BPZ:QAX34.1	QAX34.1
Room unit with sensor, setpoint and operating mode selector, display and PPS2 interface	N1640	BPZ:QAX34.3	QAX34.3
Flush-mounted room unit complete with PPS2 interface and design frame	N1649	BPZ:QAX84.1/PPS2	QAX84.1/PPS2
Versatile room unit with LonWorks interface, lighting systems (on / off)	N1648	S55623-H114	QAX50.5/C000
Versatile room unit with LonWorks interface, lighting systems (dimmed)	N1648	S55623-H115	QAX51.5/C000
Room unit with EnOcean interface	N1663	S55623-H104	QAX95.4
Room unit with EnOcean interface, setpoint adjuster	N1663	S55623-H105	QAX96.4
Room unit with EnOcean interface, setpoint adjuster, button and switch	N1663	S55623-H106	QAX97.4
Room unit with EnOcean interface, setpoint adjuster, button and switch for fan stages	N1663	S55623-H107	QAX98.4
Radio frequency receiver with Gateway EnOcean/LonWorks, AC / DC 24 V, external antenna	N1661	S55842-Z100	RXZ95.1/LON
Universal setpoint adjuster with PPS2 interface	N1646	BPZ:QAX39.1	QAX39.1

Temperature sensors for RXC..

Product Title	Data sheet	Stock No.	Product No.
Room temperature sensor LG-Ni1000	N1721	BPZ:QAA24	QAA24
Front module with passiv temperature measurement, LG-Ni1000	N1408	S55720-5133	AQR2531ANW
Room temperature sensor LG-Ni1000 for mounting on recessed conduit boxes	N1722	BPZ:QAA64	QAA64
Duct temperature sensor 400 mm, LG-Ni1000	N1761	BPZ:QAM2120.040	QAM2120.040
Cable temperature sensor PVC 2 m, LG-Ni1000	N1831	BPZ:QAP22	QAP22

For the complete flush mounting sensor offering including mounting plates and frames, see product catalog chapter 6

Indoor air quality sensors for RXC..

Product Title	Data sheet	Stock No.	Product No.
Room air quality sensor CO ₂ / temperature / rel. Humidity / VOC	N1961	BPZ:QPA20..	QPA..
Base modules with integrated CO ₂ and VOC measurement	N1410	BPZ:AQR2548..	AQR2548..
Duct air quality sensor CO ₂ / temperature / rel. Humidity / VOC	N1962	BPZ:QPM21..	QPM..

For the complete flush mounting sensor offering including mounting plates and frames, see product catalog chapter 6

Dewpoint sensors for RXC..

Product Title	Data sheet	Stock No.	Product No.
Condensation monitor, AC/DC 24 V	N3302	S55770-T325	QXA2601
Condensation monitor, AC/DC 24 V, with remote sensor head (cable length 1.5 m)	N3302	S55770-T326	QXA2602
Condensation monitor, AC 230 V	N3302	S55770-T327	QXA2603
Condensation monitor, AC 230 V, with remote sensor head (cable length 1.5 m)	N3302	S55770-T328	QXA2604

Differential pressure sensors for RXC..

Product Title	Data sheet	Stock No.	Product No.
Air duct differential pressure sensor, DC 0...10 V	N1916_01	BPZ:QBM3020..	QBM3020..
Differential pressure sensor, DC 0...10 V	N1910_01	BPZ:QBM2030..	QBM2030..
Air duct differential pressure sensor with calibration certificate	N1919_01	BPZ:QBM400..	QBM400..

Valve actuators for RXC..

Product Title	Data sheet	Stock No.	Product No.
Electrothermal actuator, AC/DC 24 V, NC, 2P, PDM, PR	N4884	S55174-A115	STA73PR/00
Electrothermal actuator, AC/DC 24 V, NO, 2P, PDM, PR	N4884	S55174-A116	STP73PR/00
Electromotoric actuator, 100 N, 2.5/5 mm, 1.5 m, AC 24 V, 3P	N4893	BPZ:SSA81	SSA81
Electromotoric actuator, 200 N, 5.5 mm, AC 24 V, 1.5 m, 3P	N4891	BPZ:SSB81	SSB81
Electromotoric actuator, 160 N, 2.5 mm, 1.5 m, AC 24 V, 3P	N4864	BPZ:SSP81	SSP81

For suitable combination of actuator STA.. and connection cable ASY.., see chapter introduction page 7-4 of the HVAC Catalog

Room automation

Desigo RX

Communicating controllers - RXC (LonWorks)

Damper actuators for RXC..

Product Title	Data sheet	Stock No.	Product No.
Rotary air damper actuators 5 Nm, without spring return	N4634	BPZ:GDB..1E	GDB..1E
Linear air damper actuators 125 N, without spring return	N4664	BPZ:GDB..2E	GDB..2E
Rotary air damper actuators 10 Nm, without spring return	N4634	BPZ:GLB..1E	GLB..1E
Linear air damper actuators 250 N, without spring return	N4664	BPZ:GLB..2E	GLB..2E

Service units

Product Title	Data sheet	Stock No.	Product No.
Service unit with LCD	N3851	BPZ:RXT20.1	RXT20.1

4

Room unit with PPS2 interface

QAX3..

Room units for acquiring the room temperature and operation of individual room control.

Power consumption	0.10 VA
Interface for controller	PPS2
Interface for service	PPS2 on RJ45
Sensing element, temperature	NTC
Measuring range, temperature	0...40 °C
Time constant	≤8 min
Measurement accuracy	±0.25 K at 25 °C ±0.5 K at 5...30 °C
Setpoint readjustment range	±12 K
Degree of protection	IP30
Mounting location	Indoors
Mounting	Directly on wall In recessed or top-mounted conduit box

Room unit with sensor and PPS2 interface

QAX30.1

- Acquisition of room temperature

Data sheet	N1741
Voltage supply	PPS2
Dimensions (W x H x D)	90 x 100 x 32 mm



Stock No.	Product No.
BPZ:QAX30.1	QAX30.1

Room unit with sensor, setpoint adjuster and PPS2 interface

QAX31.1

- Acquisition of room temperature
- Setpoint adjuster for room temperature

Data sheet	N1741
Dimensions (W x H x D)	90 x 100 x 36 mm



Stock No.	Product No.
BPZ:QAX31.1	QAX31.1

Room unit with sensor, setpoint and operating mode selector and PPS2 interface

QAX32.1

- Acquisition of room temperature
- Setpoint adjuster for room temperature
- Rocker switch for mode selection (Off / Auto)

Data sheet	N1641
Dimensions (W x H x D)	90 x 100 x 36 mm



Stock No.	Product No.
BPZ:QAX32.1	QAX32.1

Room automation

Room operator units

For controllers RX.. (PPS2): QAX3.. / QAX8..

QAX33.1



Room unit with sensor, setpoint and operating mode selector, fan speed selection, and PPS2 interface

- Acquisition of room temperature
- Setpoint adjuster for room temperature
- Rocker switch for mode selection (Off/Auto) and for manual fan control with fan coil systems (up to 3 speeds)

Data sheet N1642

Dimensions (W x H x D) 90 x 100 x 36 mm

Stock No.

Product No.

BPZ:QAX33.1

QAX33.1

QAX34.1



Room unit with sensor, setpoint and operating mode selector, display and PPS2 interface

- Acquisition of room temperature
- Rocker switch for adjustment of room temperature setpoint
- Rocker switch for mode selection (Off/Auto) and for manual fan control with fan coil systems (up to 3 speeds)
- LCD with display of room temperature and control mode

Data sheet N1645

Dimensions (W x H x D) 90 x 100 x 36 mm

Stock No.

Product No.

BPZ:QAX34.1

QAX34.1

QAX34.3



Room unit with sensor, setpoint and operating mode selector, display and PPS2 interface

- Acquisition of room temperature
- Rocker switch for adjustment of room temperature setpoint
- Rocker switch for mode selection (Off/Auto) and for manual fan control with fan coil systems (up to 3 speeds)
- LCD with display of room temperature and control mode
- Together with the new RXB and RXL controllers for parameter setting

Data sheet N1640

Dimensions (W x H x D) 96 x 119 x 24 mm

Stock No.

Product No.

BPZ:QAX34.3

QAX34.3

QAX39.1



Universal setpoint adjuster with PPS2 interface

- Setpoint adjuster for room temperature

Data sheet N1646

Dimensions (W x H x D) 48 x 48 x 15 mm

Stock No.

Product No.

BPZ:QAX39.1

QAX39.1

Room automation
Room operator units
For controllers RX.. (PPS2): QAX3.. / QAX8..

Flush-mounted room unit complete with PPS2 interface and design frame

QAX84.1/PPS2

The set consists of:

- Operator unit,
- PPS2 bus coupling unit and
- Design frame DELTA line in titanium white.

Functionality:

- Acquisition of room temperature
- Switch for adjustment of room temperature setpoint
- Switch for mode selection (Off/Auto) and for manual fan control with fan coil systems (up to 3 speeds)
- LCD with display of room temperature and control mode



Data sheet	N1649
Voltage supply	PPS2
Measuring range, temperature	0...40 °C
Sensing element, temperature	NTC
Mounting	Flush or wall-mounted conduit box
Degree of protection	IP30
Dimensions (W x H x D)	80 x 80 x 30.5 mm

Stock No.

Product No.

BPZ:QAX84.1/PPS2

QAX84.1/PPS2



QAX95.4



Room unit with EnOcean interface

- Acquisition of the room temperature
- Powered by solar cell
- A gateway is mandatory (EnOcean / KNX)
- Optional use of battery if light conditions are insufficient
- Including design frame DELTA line, titan white

For use with units from the following product ranges:

- RXB (together with gateway EnOcean/KNX, RXZ97.1/KNX)
- Devices with KNX Communication

Data sheet	N1663
Voltage supply	Solar cell
Measuring range, temperature	0...50 °C
Measurement accuracy	±0.4 K
Time constant	≤16 min
Degree of protection	IP30
Dimensions (W x H x D)	55 x 55 x 19 mm
Weight	0.05 kg

Stock No. Product No.

S55623-H104 **QAX95.4**

QAX96.4



Room unit with EnOcean interface, setpoint adjuster

- Acquisition of the room temperature
- Room temperature setpoint adjustment
- Powered by solar cell
- A gateway is mandatory (EnOcean / KNX)
- Optional use of battery if light conditions are insufficient
- Including design frame DELTA line, titan white

For use with units from the following product ranges:

- RXB (together with gateway EnOcean/KNX, RXZ97.1/KNX)
- Devices with KNX Communication

Data sheet	N1663
Voltage supply	Solar cell
Measuring range, temperature	0...50 °C
Measurement accuracy	±0.4 K
Time constant	≤16 min
Setpoint readjustment range	±10 K
Degree of protection	IP30
Dimensions (W x H x D)	55 x 55 x 28 mm
Weight	0.05 kg

Stock No. Product No.

S55623-H105 **QAX96.4**

For controllers RX.. and room automation (BACnet) (EnOcean and wireless)

Room unit with EnOcean interface, setpoint adjuster, button and switch

QAX97.4

- Acquisition of the room temperature
- Room temperature setpoint adjustment
- Freely-programmable button
- Step switch (2 stages)
- Powered by solar cell
- A gateway is mandatory (EnOcean / KNX)
- Optional use of battery if light conditions are insufficient
- Including design frame DELTA line, titan white



For use with units from the following product ranges:

- RXB (together with gateway EnOcean/KNX, RXZ97.1/KNX)
- Devices with KNX Communication

Data sheet	N1663
Voltage supply	Solar cell
Measuring range, temperature	0...50 °C
Measurement accuracy	±0.4 K
Time constant	≤16 min
Setpoint readjustment range	±10 K
Degree of protection	IP30
Dimensions (W x H x D)	55 x 55 x 28 mm
Weight	0.05 kg

Stock No.	Product No.
S55623-H106	QAX97.4

Room unit with EnOcean interface, setpoint adjuster, button and switch for fan stages

QAX98.4

- Acquisition of the room temperature
- Room temperature setpoint adjustment
- Freely-programmable button
- Step switch (5 stages)
- Powered by solar cell
- A gateway is mandatory (EnOcean / KNX)
- Optional use of battery if light conditions are insufficient
- Including design frame DELTA line, titan white



For use with units from the following product ranges:

- RXB (together with gateway EnOcean/KNX, RXZ97.1/KNX)
- Devices with KNX Communication

Data sheet	N1663
Voltage supply	Solar cell
Measuring range, temperature	0...50 °C
Measurement accuracy	±0.4 K
Time constant	≤16 min
Setpoint readjustment range	±10 K
Degree of protection	IP30
Dimensions (W x H x D)	55 x 55 x 28 mm
Weight	0.05 kg

Stock No.	Product No.
S55623-H107	QAX98.4

AP 221

Wall transmitter, EnOcean, single, DELTA i-system

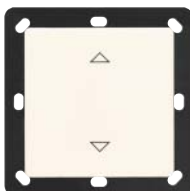

- One centered rockers
- Vertical operation
- Energy generation at the button press by means of induction, without batteries, maintenance-free
- Up to 2 pushbutton functions per rocker
- Selectable function per pushbutton: Switching Over, Switching On, Switching Off, 8-bit value, 1 pushbutton dimming, 1 pushbutton sun protection control
- For the pushbutton pair selectable function Switching ON/OFF, 2-button dimming with stop telegram, 2-button sun protection control
- Radio telegram according to EnOcean standard at 868.3 MHz
- Transmitting power of max. 10 mW
- As surface-mounting unit for screwing or sticking

Dimensions (W x H x D) 55 x 55 x 7.3 mm

4

Product Title	Stock No.	Product No.
Wall transmitter, EnOcean, titanium white	5WG4221-3AB10	AP 221/10
Wall transmitter EnOcean, aluminum metallic	5WG4221-3AB30	AP 221/30
Wall transmitter EnOcean, with I/O-symbols, titanium white	5WG4221-3AB11	AP 221/11
Wall transmitter EnOcean, with I/O-symbols, aluminum metallic	5WG4221-3AB31	AP 221/31
Wall transmitter EnOcean, with up/down-symbols, titanium white	5WG4221-3AB12	AP 221/12
Wall transmitter EnOcean, with up/down-symbols, aluminum metallic	5WG4221-3AB32	AP 221/32

The matching design frame must be ordered separately. See chapter Display and Operation Units - Pushbuttons.

For controllers RX.. and room automation (BACnet) (EnOcean and wireless)

AP222 Wall transmitter, EnOcean, double, DELTA i-system

AP 222

- Two centered rockers
- Vertical operation
- Energy generation at the button press by means of induction, without batteries, maintenance-free
- Up to 2 pushbutton functions per rocker
- Selectable function per pushbutton: Switching Over, Switching On, Switching Off, 8-bit value, 1 pushbutton dimming, 1 pushbutton sun protection control
- For the pushbutton pair selectable function Switching ON/OFF, 2-button dimming with stop telegram, 2-button sun protection control
- Radio telegram according to EnOcean standard at 868.3 MHz
- Transmitting power of max. 10 mW
- As surface-mounting unit for screwing or sticking

Dimensions (W x H x D) 55 x 55 x 7.3 mm

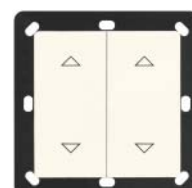
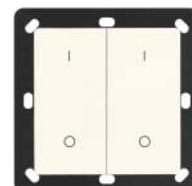
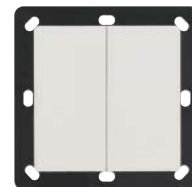

4

Product Title	Stock No.	Product No.
Wall transmitter EnOcean, titanium white	5WG4222-3AB10	AP 222/10
Wall transmitter EnOcean, aluminum metallic	5WG4222-3AB30	AP 222/30
Wall transmitter EnOcean, with I/O-symbols, titanium white	5WG4222-3AB11	AP 222/11
Wall transmitter EnOcean, with I/O-symbols, aluminum metallic	5WG4222-3AB31	AP 222/31
Wall transmitter EnOcean, with up/down symbols, titanium white	5WG4222-3AB12	AP 222/12
Wall transmitter EnOcean, with up/down symbols, aluminum metallic	5WG4222-3AB32	AP 222/32

The matching design frame must be ordered separately. See chapter Display and Operation Units - Pushbuttons.

RXZ95.1/LON



Radio frequency receiver with Gateway EnOcean/LonWorks, AC / DC 24 V, external antenna

- Wireless receiver with LonWorks® interface FTT10A
- Evaluation of up to 9 EnOcean room units (room temperature and setpoint adjustment)

For use with:

- Desigo RXC
- Devices / systems with LonWorks® communication

An external antenna is included in the delivery.

Data sheet	N1661
Operating voltage	DC 24 V AC 24 V
Voltage supply	LonWorks bus (LPT10)
Power consumption	0.82 VA
Ambient temperature, operation	-20...60 °C
Ambient humidity, operation	<70 % r.H.
Degree of protection	IP42
Dimensions (W x H x D)	58 x 78 x 46 mm
Weight	0.173 kg

Stock No.

Product No.

S55842-Z100

RXZ95.1/LON

RXZ97.1/KNX



Radio frequency receiver with Gateway EnOcean/KNX

- Evaluation of up to 32 EnOcean channels
- With RXB, other EnOcean functions may also be integrated: switches, window contacts, motion detectors
- Other EnOcean functions (dimming, blinds, light sensors) can be realized in KNX systems
- Powered via KNX bus
- With internal antenna



Data sheet	N1662
Operating voltage	DC 24 V
Voltage supply	KNX bus
Power consumption	0.6 VA
Ambient temperature, operation	-5...45 °C
Ambient humidity, operation	5...93 % r.H.
Degree of protection	IP20
Dimensions (W x H x D)	71 x 71 x 27 mm
Weight	0.07 kg

Stock No.

Product No.

S55842-Z101

RXZ97.1/KNX

For communicating controller - RXC (LonWorks) QAX5..

QAX5..



Versatile room units with LonWorks interface

Versatile room units with LonWorks bus communication.

- Acquisition of room temperature
- Buttons for adjustment of room temperature setpoint
- Rocker switch for selecting the HVAC operating state (Off / Auto) and for manual fan speed control with fan coil systems (up to 3 speeds)
- LCD with display of room temperature and operating state
- Configurable keypad for operation of lighting and blinds
- LonMark-compatible bus communication

Data sheet	N1648
Voltage supply	LonWorks bus (LPT10)
Communication	Bus: LonWorks
Mounting location	Indoors
Mounting	Directly on wall In recessed or top-mounted conduit box
Dimensions (W x H x D)	80 x 187 x 20 mm

Versatile room unit with LonWorks interface, lighting systems (on / off)

QAX50.5/C000

For operating HVAC systems and controlling lighting systems (on / off) and blinds.

Data sheet	N1648
------------	-------

	Stock No.	Product No.
	S55623-H114	QAX50.5/C000

Versatile room unit with LonWorks interface, lighting systems (dimmed)

QAX51.5/C000

For operating HVAC systems and controlling lighting systems (dimmed) and blinds.

Data sheet	N1648
------------	-------

	Stock No.	Product No.
	S55623-H115	QAX51.5/C000

Room automation
Service unit
For controller RXC..

RXT20.1

Service unit with LCD



Data sheet	N3851
Voltage supply	PPS2
Power consumption	0.1 VA
Ambient temperature, operation	0...50 °C
Weight	0.13 kg

Stock No.

Product No.

BPZ:RXT20.1

RXT20.1

4

Standard Controllers



Overview and selection tool	Product range overview	5-2	
Communicating HVAC controllers - Synco™ 700	Heating controllers RMH..	5-9	
	Extension modules for RMH..	5-11	
	Boiler sequence controllers RMK..	5-12	
	Extension modules and operator units for RMH.. and RMK..	5-14	
	Application examples RMH.. / RMK..	5-16	
	Field devices for RMH.. and RMK..	5-21	
	Universal controllers RMU..	5-22	
	Application examples RMU..	5-24	
	Switching and monitoring device RMS..	5-33	
	Extension modules and operator units for RMU.. and RMS..	5-35	
	Field devices for RMU.. and RMS..	5-37	
	Software and central communication units	For web and remote operation via KNX: OZW77..	5-41
		Operating, service and alarm software for HVAC plants: ACS790	5-45
Interface for HVAC plants: OCI70..		5-46	

One system for all types of applications

Synco operating – efficient operation of plant with straightforward remote control

Thanks to Synco's Web server, plant operation and monitoring can be effected from a PC or smartphone at any time and from any location. An alarm system delivers fault status or maintenance messages in due time, also via SMS or e-mail, if required. The app allows your customers operation from underway or from the sofa.

Synco tool – support functions for quick commissioning

To facilitate commissioning, the Synco tool offers you a host of help functions and choices: Diagnostics including trending, for example, straightforward fault tracing thanks to access to all data points of all controllers, saving all settings on the PC, or printing commissioning reports.

Simple concept for opening communication

With Synco, opening and starting communication is child's play: Simply interconnect the units, activate the bus power supply on the controller and set the device address. All relevant settings can be made directly via local operation.

Open data exchange via KNX standard bus, irrespective of supplier

The KNX standard bus facilitates interconnections of HVAC, lighting and blind control, for instance, regardless of the supplier – for simultaneous control of the ventilation system and of lighting via presence detectors, for example.

Synco tool

For commissioning and diagnostics

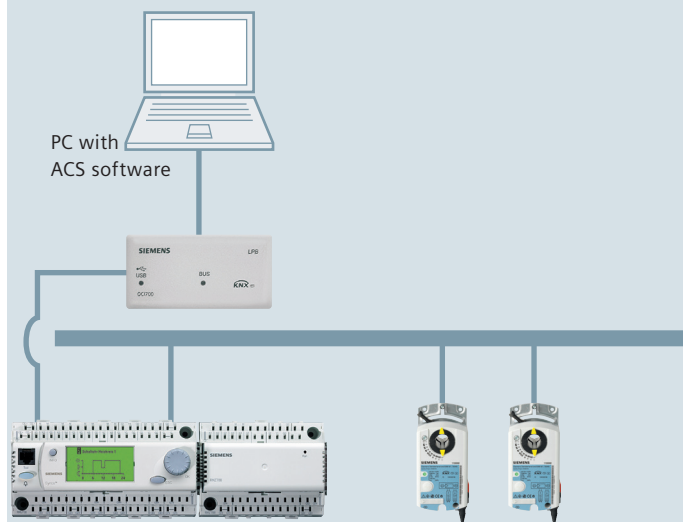

Control and switching unit for heating, ventilation and air conditioning plants

Synco 700

Universal controllers

- RMU710** modular universal controller, 1 control loop
- RMU720** modular universal controller, 2 control loops
- RMU730** modular universal controller, 3 control loops
- RMS705** switching and monitoring device

Universal extension modules (for all types of controllers)

- RMZ785** universal module
- RMZ787** universal module
- RMZ788** universal module

Operator units (for all types of controllers)

- RMZ790** plug-in type operator unit
- RMZ791** detached operator unit (3 m)
- RMZ792** bus operator unit

Field devices

- GDB181.1E/KN** VAV compact controller (5 Nm)
- GLB181.1E/KN** VAV compact controller (10 Nm)

Synco operating

Efficient operation of plant including alarm reporting

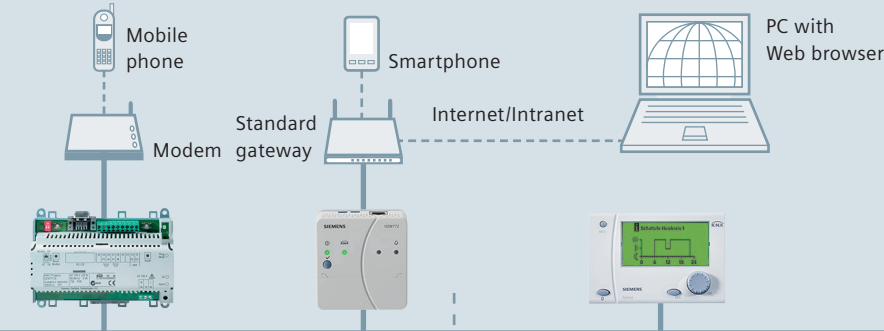

The world's only open standard for home and building control – ISO/IEC 14543-3



Control and switching unit for heating, ventilation and air conditioning plants



Central control unit and room controller for individual room climate



Synco RXB/RXL room controllers, Synco RDG/RDF/RDU room thermostats

Heating controllers

- RMH760** modular heating controller
- RMK770** boiler sequence controller

Extension modules for heating controllers

- RMZ782** heating circuit module
- RMZ783** DHW module
- RMZ787** universal module
- RMZ789** universal module

Room unit

- QAW740** room unit

Synco operating

- OZW771** central communication unit
- OZW772** Web server (Ethernet)

Synco tool

- OCI700.1** service tool
- ACS790** commissioning software

Central control unit

- RMB795**
– Central control unit for room controllers

Room controllers

- RXB21.1, RXL21.1, RXB22.1, RXL22.1, RXB39.1, RXL39.1**

- Fan coil units

- RXB24.1, RXL24.1**

- Chilled ceiling or radiator

Room thermostats

- RDG100KN, RDG160KN**

- Fan coil units
- Universal system, chilled/heated ceiling and radiator
- Heat pump systems

- RDG400KN**

- Variable air volume system

- RDF301, RDF301.50, RDF600KN**

- Fan coil units
- Heat pump systems
- Semi-flush mount

- RDU341**

- Variable air volume system
- Semi-flush mount

- RDF800KN**

- Fan coil units
- Touch room thermostat
- Semi-flush mount

Standard Controllers

Overview and selection tools

Product range overview

Synco IC

Easy and secure remote access and plant overview

Synco IC is a web-based Remote Access System. Setting-up Internet access to your plant is easy: just connect your web server OZW with the Internet, create your user account on the web page and enter the key for your web server OZW.

www.siemens-syncoic.com

5

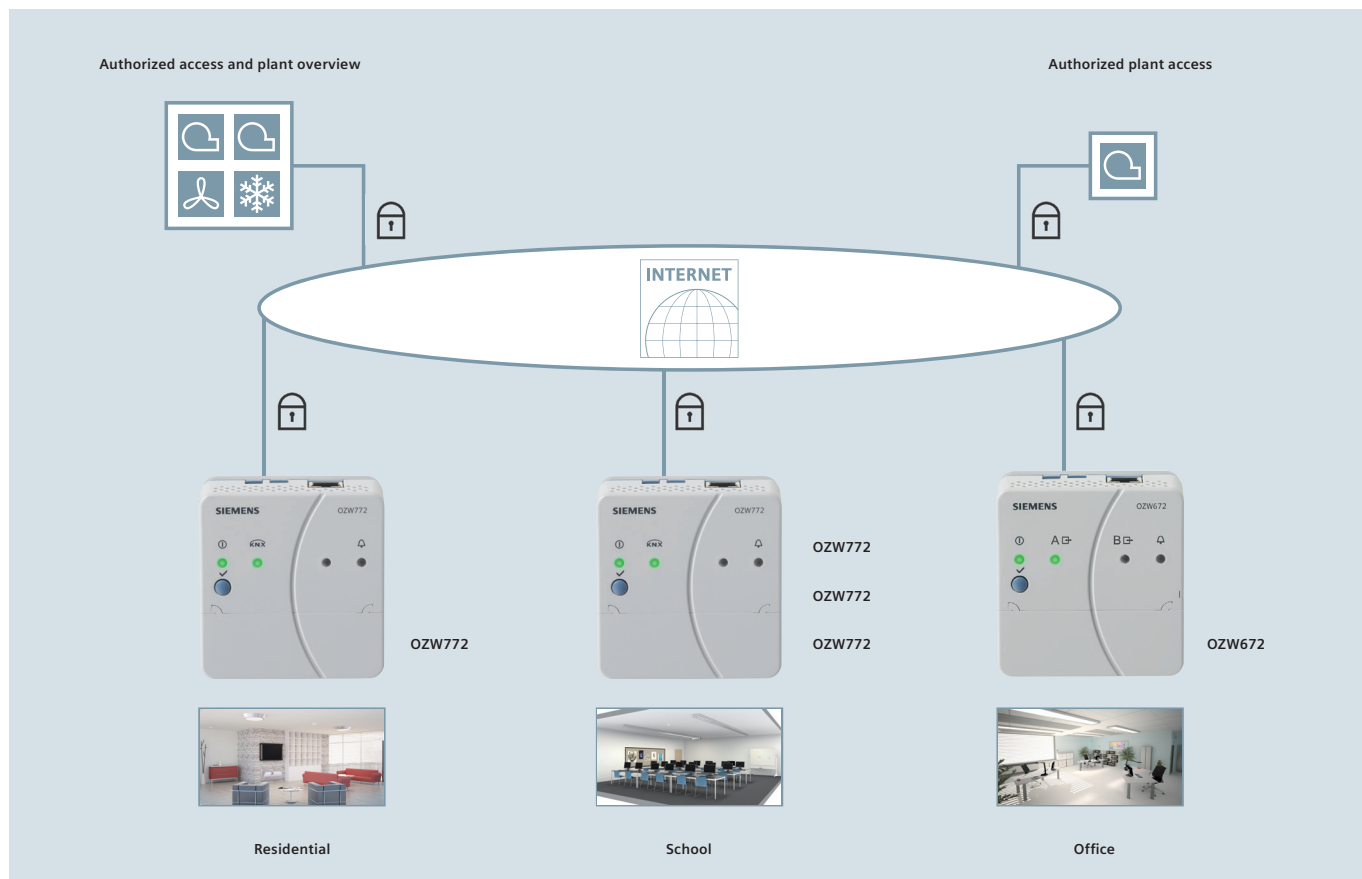

Overview HVAC controller



	RMH.. 760	RMK.. 770	710	RMU.. 720	730	RMS.. 705	785	787	RMZ..			
	788	782	783	789								
	Modular heating controller max. 3 heating circuit	Boiler sequence controller	Modular universal controller, 1 control loop	Modular universal controller, 2 control loops	Modular universal controller, 3 control loops	Switching and Monitoring Device	Universal module, 8UI	Universal module, 4UI, 4DO	Universal module, 4UI, 2DO, 2AO	Heating circuit module 3UI, 3DO, 1AO	DHW module 4UI, 5DO, 1AO	Universal module, 6UI, 2AO, 4DO
Operation	■ ¹⁾		■ ¹⁾	■ ¹⁾	■ ¹⁾	■ ¹⁾						
KNX communication	■		■	■	■	■						
7-day time switch and holiday/ special day program	■		■	■	■	■						
Supervision	■		■	■	■	■						
Logic functions	■		■	■	■	■						
Outputs												
Step switch	■	■	■	■	■	■						
Relay	5	7	2	4	6	6		4	2	3	5	4
3-position												
DC 0...10 V	2	2	2	3	4	4			2	1	1	2
Universal inputs												
T1	■	■	■	■	■	■	■	■	■	■	■	■
Pt1000	■	■	■	■	■	■	■	■	■	■	■	■
DC 0...10 V	■	■	■	■	■	■	■	■	■	■	■	■
Digital	■	■	■	■	■	■	■	■	■	■	■	■
LG-Ni 1000	■	■	■	■	■	■	■	■	■	■	■	■
Number of universal inputs	■	■	6	8	8	8	8	4	4	3	4	6
Controlled variable												
Universal	■	■	■	■	■	■						
Temperature °C	■	■	■	■	■	■						
Control mode												
PID	■		■	■	■	■						
P/PI	■		■	■	■	■						
Control loops												
Cascade	■		■	■	■	■						
Number	3		1	2	3	3						

■ ¹⁾ Optional operation:
RMZ790: Plug-in operator unit
RMZ791: Detached operator unit
RMZ792: Bus operator unit

AO Analog output
DO Digital output
UI Universal inputs

Standard Controllers

Overview and selection tools

Product range overview

Overview standard systems

Communication	KNX (Konnex)
Standard systems for:	Heating, ventilation or air conditioning
Communication central unit	OZW771.. OZW772..
Software	ACS790
Service Tool	OCI700.1
USB-KNX Interface with Bus Power supply	OCI702
Heating controllers	Synco™ ■ RMH760 Heating controllers ■ RMK770 Boiler sequence controllers
Ventilation and air conditioning controllers	Synco™ series ■ RMU700 Universal controllers
Switching and Monitoring Device	Synco™ ■ RMS705
Room controllers	Synco™ ■ RMB795 Control center ■ RXB / RXL Room controllers
Home Automation System	Synco™ living ■ QAX903, QAX913
Thermostats	Synco™ ■ RDF301, RDF301.50, RDF600KN ■ RDG100KN, RDG160KN, RDG400KN, RDG800KN ■ RDU341
Flush-mount room sensor	■ AQR253.. ■ AQR257..
Wall-mount room sensor	■ QMX3.P30 ■ QMX3.P70

5

Synco Webservice

Standard systems for heating, ventilation or air conditioning Synco™ (KNX)

Low engineering system to easily build complex applications with flexible and modular combinations of standard controllers Synco™ 700. Standard Systems for HVAC plants are capable to be remote operated and can generate alarms to service centers. Full control without extensive engineering.

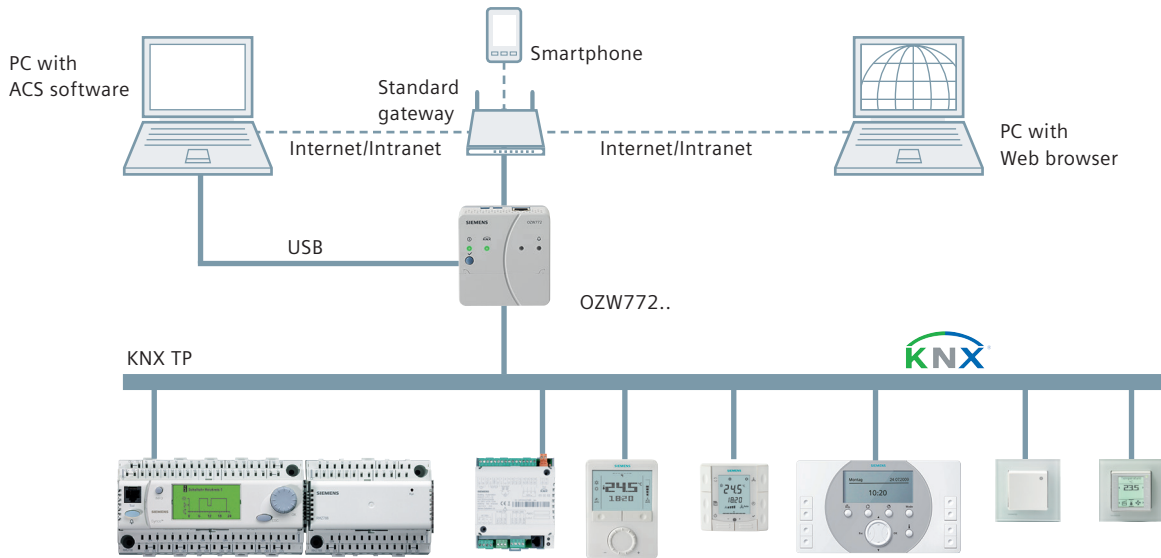

5

Webservice	OZW772			
	OZW772.01	OZW772.04	OZW772.16	OZW772.250
Device versions	OZW772.01	OZW772.04	OZW772.16	OZW772.250
No. of Synco devices ¹⁾	1	4	16	250
KNX S-Mode Datenpunkte	7	237	237	237
Plant operation				
ACS software	Yes			
Web Browser	Yes			
Interface	Ethernet, USB			
Alarming				
Max. message receivers	4			
ACS alarm via PC	No			
Fax	No			
Pager	No			
SMS	No			
e-Mail	Yes (Ethernet)			
Offline trend function	Yes			
Digital alarm inputs (potential free)	None			
Local device operation	Button / Switch			
Bus power supply	No			
General device data				
Operating voltage	AC 230 V ±10 %			
Frequency	50/60 Hz			
Power consumption	3 VA			
Degree of protection	IP30			

¹⁾ Synco™ controller series 700, QAW740, RXB.. / RXL.., RDG.., RDF.., RDU.., Synco™ living QAX9..

Standard Controllers

Overview and selection tools

Product range overview

Synco Communication central unit with RS-232 Modem connection

Standard systems for heating, ventilation or air conditioning Synco™ (KNX)

Low engineering system to easily build complex applications with flexible and modular combinations of standard controllers Synco™ 700. Standard Systems for HVAC plants are capable to be remote operated and can generate alarms to service centers. Full control without extensive engineering.

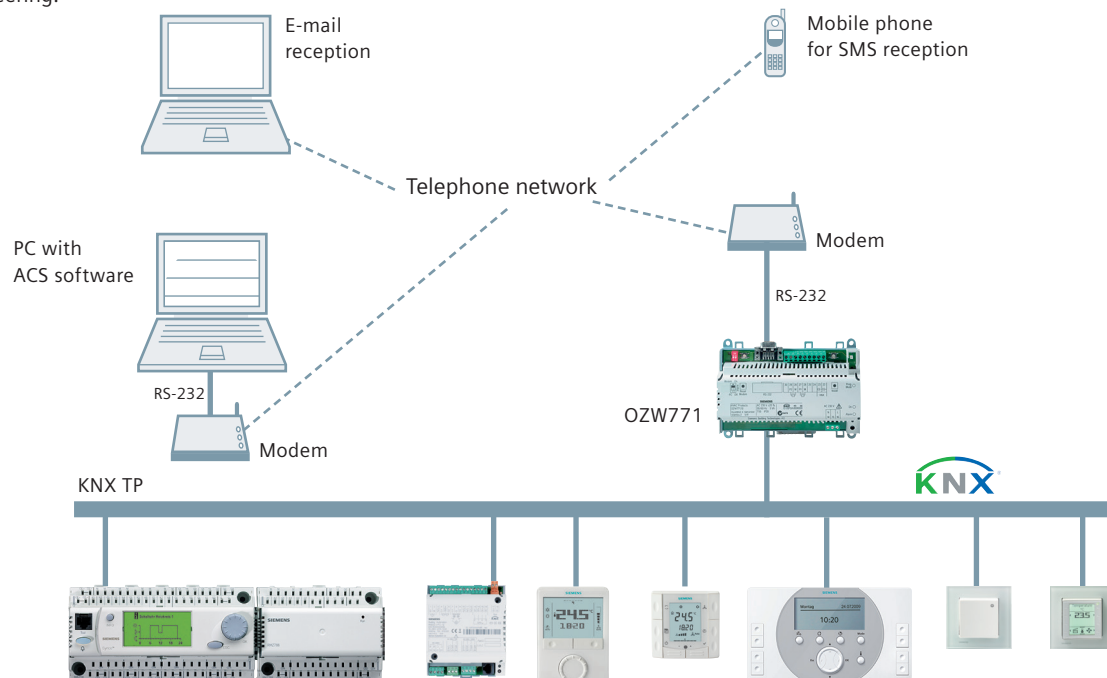

Communication central units	OZW771		
	OZW771.04	OZW771.10	OZW771.64
Device versions	OZW771.04	OZW771.10	OZW771.64
No. of Synco devices ¹⁾	4	10	64
Plant operation			
ACS software	Yes		
Web Browser	No		
Interface	RS232		
Alarming			
Max. message receivers	2		
ACS alarm via PC	Yes		
Fax	with SMS via GSM		
Pager	Yes		
SMS	Yes		
e-Mail	with SMS via GSM		
Offline trend function	No		
Digital alarm inputs (potential free)	2		
Local device operation	Button / Switch		
Bus power supply	No		
General device data			
Operating voltage	AC 230 V ±10 %		
Frequency	50/60 Hz		
Power consumption	5 VA		
Degree of protection	IP20 ²⁾		

¹⁾ Synco™ controller series 700, QAW740, RXB.. / RXL., RDG., RDF., RDU., Synco™ living QAX9..

²⁾ IP30 with terminal covers

RMH760B..



Heating controller

- Heating controller as primary controller or main controller (district heat) or heating circuit controller
- Boiler temperature control
- Control of max. 3 heating circuits and DHW heating (7 variants available) with optional extension modules
- Tested, predefined applications (refer to Application Catalog)
- Flexible configuration
- Clear-text operation with separate operator unit (plug-in type or detached)
- Integrated KNX bus communication
- No commissioning tool required

Extension modules complement the Synco 700 heating controller and offer extra functions. Controller and extension modules are interconnected via plug-in connectors. The extension modules are attached to the controller and do not operate autonomously. Full operation from commissioning to enduser operation via the operator unit.

Available extension modules:

2 heating circuit modules RMZ782B

1 DHW module RMZ783B

1 universal module RMZ787

2 universal modules RMZ789

A total of 4 extension modules can simultaneously be used with the Synco 700 heating controller.

Available operator units:

- Plug-in type operator unit RMZ790
- Detached operator unit RMZ791
- Bus operator unit RMZ792

Data sheet	N3133
Operating voltage	AC 24 V
Frequency	50/60 Hz
Power consumption	12 VA
Universal inputs, number	6
Universal input, signal	LG-Ni1000 2 x LG-Ni1000 T1 (PTC) Pt1000 NTC 575 0...1000 Ohm 1000...1175 Ohm DC 0...10 V Digital pulse contact Potential-free digital status contact
Analog outputs, number	2
Analog output, signal	DC 0...10 V
Analog output, current	Max. 1 mA
Relay outputs, number	5
Relay outputs	Potential-free switching contact
Relay output, switching voltage	AC 19...250 V
Relay output, switching current	4 (3) A
Communication	KNX (KNX TP1)

Standard controllers
Communicating HVAC controllers
Heating controllers RMH..

Range overview RMH760B..

Product Title	Data sheet	Stock No.	Product No.
Heating controller with languages de, fr, it, es	N3133	BPZ:RMH760B-1	RMH760B-1
Heating controller with languages de, en, fr, nl	N3133	BPZ:RMH760B-2	RMH760B-2
Heating controller with languages da, fi, sv, no	N3133	BPZ:RMH760B-3	RMH760B-3
Heating controller with languages pl, cs, sk, hu, ru, bg	N3133	BPZ:RMH760B-4	RMH760B-4
Heating controller with languages sr, hr, sl, ro, el, tr	N3133	BPZ:RMH760B-5	RMH760B-5

Heating circuit module

RMZ782B

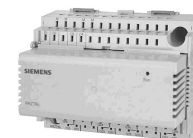

- Weather-compensated flow temperature control via heating circuit's mixing valve
- Control of heating circuit pump

The available heating circuit control and supervisory functions are the same as those of the RMH760B

Data sheet	N3136
Voltage supply	Supply from controller module
Power consumption	2 VA
Universal inputs, number	3
Universal input, signal	LG-Ni1000 0...1000 Ohm 1000...1175 Ohm DC 0...10 V Pt1000 NTC 575 T1 (PTC)
Analog outputs, number	1
Analog output, signal	DC 0...10 V
Analog output, current	Max. 1 mA
Relay outputs, number	3
Relay outputs	Switching contact, potential-free
Relay output, switching voltage	AC 19...250 V
Relay output, switching current	4 (3) A

Stock No.	Product No.
BPZ:RMZ782B	RMZ782B

DHW module

RMZ783B

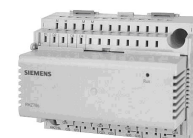

- Control of the storage tank temperature
- Storage tank charging with integrated coil, with pump or mixing valve
- Storage tank charging with detached heat exchanger, with pump and mixing valve
- Storage tank charging according to a time program
- Control of the circulating pump according to a time program

The technical data correspond to the heating circuit module RMZ782B, except:

Data sheet	N3136
Universal inputs, number	4
Analog outputs, number	1
Relay outputs, number	5

Stock No.	Product No.
BPZ:RMZ783B	RMZ783B

5

RMK770..



Boiler sequence controller

Modular heating controller with integrated control and supervisory functions for:

- Up to 6 boilers
- Multistage or modulating burners
- Precontrol
- Heating circuit
- Tested, predefined applications (refer to Application Catalog)
- Flexible configuration
- Clear-text operation with separate operator unit (plug-in type or detached)
- Integrated KNX bus communication
- No commissioning tool required

Extension modules complement the Synco 700 boiler sequence controller and offer extra functions. The extension modules are attached to the controller. They do not operate autonomously. Full operation from commissioning to enduser operation via the operator unit.

Available extension modules:

- 3 universal modules RMZ785
- 3 universal modules RMZ787
- 3 universal modules RMZ788
- 3 universal modules RMZ789

A total of 3 extension modules can simultaneously be used with the Synco 700 boiler sequence controller.

Available operator units:

- Plug-in type operator unit RMZ790
- Detached operator unit RMZ791
- Bus operator unit RMZ792

Data sheet	N3132
Operating voltage	AC 24 V
Frequency	50/60 Hz
Power consumption	12 VA
Universal inputs, number	8
Universal input, signal	0...1000 Ohm 1000...1175 Ohm 2 x LG-Ni1000 DC 0...10 V Potential-free digital status contact LG-Ni1000 Pt1000 T1 (PTC)
Digital inputs, number	2
Digital inputs	Potential-free input signal
Digital input, contact query	5 mA DC 15 V
Analog outputs, number	2
Analog output, signal	DC 0...10 V
Analog output, current	Max. 1 mA
Relay outputs, number	7
Relay outputs	AC 19...265 V, max. 4(3) A Potential-free switching contact
Communication	KNX (KNX TP1)

Range overview RMK770..

Product Title	Data sheet	Stock No.	Product No.
Boiler sequence controller with languages de, fr, it, es	N3132	BPZ:RMK770-1	RMK770-1
Boiler sequence controller with languages de, fr, en, nl	N3132	BPZ:RMK770-2	RMK770-2
Boiler sequence controller with languages da, fi, sv, no	N3132	BPZ:RMK770-3	RMK770-3
Boiler sequence controller with languages pl, cs, sk, hu, ru, bg	N3132	BPZ:RMK770-4	RMK770-4
Boiler sequence controller with languages sr, hr, sl, ro, el, tr	N3132	BPZ:RMK770-5	RMK770-5

Standard controllers

Communicating HVAC controllers

Extension modules and operator units for RMH.. and RMK..

RMZ790



Plug-in type operator unit

- Operator unit plugs into the Synco™ 700 controllers
- For displaying and changing plant data for service staff and enduser
- Clear-text operation
- Can be plugged in and removed during operation
- Power supply via the controller

Data sheet N3111

Stock No. Product No.

BPZ:RMZ790 RMZ790

RMZ791



Detached operator unit with 3 m cable

Like plug-in type operator unit, but:

- Other mounting choices (typically for control panel door or wall mounting)
- Larger display
- Connection via a prefabricated 3 m cable, supplied as standard

Data sheet N3112

Stock No. Product No.

BPZ:RMZ791 RMZ791

RMZ792



Bus operator unit

Communicating operator unit for operating up to 150 controllers, room units and central units from the Synco™ 700 range via KNX bus.

Favorite pages can be freely defined. Designed for fixed installation or mobile use.

Data sheet N3113



Stock No. Product No.

BPZ:RMZ792 RMZ792

RMZ78..

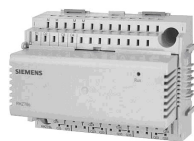

Universal modules

Additional inputs and outputs required by the Synco™ 700 controllers can be provided by these modules. A description of the functions is given with the relevant controller module.

Data sheet N3146

Power consumption	2 VA
Universal input, signal	0...1000 Ohm 1000...1175 Ohm 2 x LG-Ni1000 DC 0...10 V Potential-free digital status contact LG-Ni1000 Pt1000 T1 (PTC)
Analog output, signal	DC 0...10 V
Analog output, current	Max. 1 mA
Relay outputs	switching contact, potential-free
Relay output, switching voltage	AC 19...265 V
Relay output, switching current	4 (3) A

Standard controllers
Communicating HVAC controllers
Extension modules and operator units for RMH.. and RMK..

Range overview RMZ78..

Universal inputs, number	Analog outputs, number	Relay outputs, number	Stock No.	Product No.
8	0	0	BPZ:RMZ785	RMZ785
4	0	4	BPZ:RMZ787	RMZ787
4	2	2	BPZ:RMZ788	RMZ788
6	2	4	BPZ:RMZ789	RMZ789

Module connector

Module connector for detached mounting of extension modules within the control panel.
 Distance for detached mounting: Maximum 10 m.

Data sheet N3138

RMZ780



Stock No.	Product No.
BPZ:RMZ780	RMZ780



Standard controllers

Communicating HVAC controllers

Application examples RMH../RMK..

Application examples RMH760B.. and RMK770..

BACS Energy Performance Classes – EN 15232

High energy performance
BACS and TBM

Advanced
BACS and TBM

Standard
BACS

Non-energy-efficient
BACS

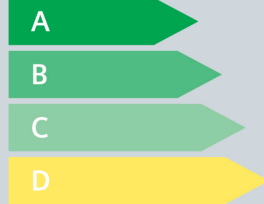

BACS Building Automation and Control System
TBM Technical Building Management System

These are only a few examples of many applications that can be done with the with Synco™700 controllers: RMH760B.. / RMK770..

More Synco™700 applications are described in "HIT" (the HVAC project engineering tool with a library of over 300 pre-configured HVAC-applications) and in the RMH760B.. / RMK770.. data sheet.

The evaluation of the energy efficiency classification is based on EN15232:2012. For a determination of the energy efficiency classification of the application, please use the "HIT Tool".

Further details are available in the manual "Building automation - impact on energy efficiency" in our HIT Online.

www.siemens.com/hit

5 RMH760B..

H0CB02 H6B HQ

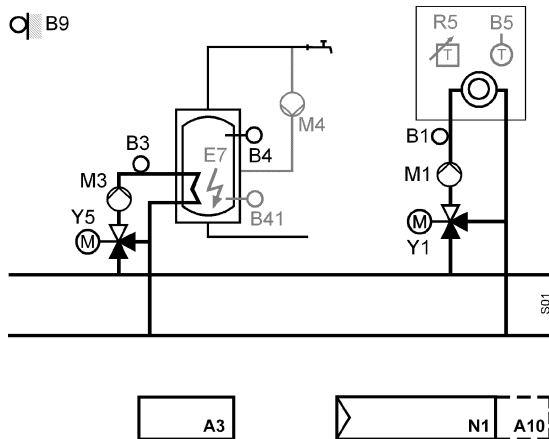

High energy performance
BACS and TBM



To fulfill the classification, the plant must be equipped with all indicated functions.

Weather-compensated heating control, one heating circuit, d.h.w

- Weather-compensated flow temperature control with adjustable setpoints for Comfort, Precomfort, Economy and Protective Mode
- Frost protection for the building and the plant
- Changeover between 3 room temperature setpoints according to the time switch program
- Yearly clock
- Holiday and special day program with up to 16 periods
- 7-day program (maximum six switching points per day)
- Time switch program for the heating circuit
- Limitation of the flow temperature
- Automatic heating limit with adjustable limits
- Optimum start control
- Quick setback
- Control of the storage tank charging temperature with adjustable setpoints for Normal, Reduced, Legionella and Protective mode
- Time switch program for DHW heating

The indicated energy efficiency classification can be attained only if the following functions are implemented:

- Integrated individual room control including demand control "by occupancy, air quality, etc." (Heating circuits for precontrol in individual room control)
- Indoor temperature control (Room temperature in individual room control via KNX requires extra configuration)
- Variable speed pump control with constant Δp (The pump must have integrated output control)
- Variable temperature depending on the load (Heat demand signal required)

Weather-compensated heating control, heat generation, 2 heating circuits, d.h.w.

RMH760B..

HCDA01 H6B HQ

- Weather-compensated flow temperature control with adjustable setpoints for Comfort, Precomfort, Economy and Protective Mode
- Frost protection for the building and the plant
- Changeover between 3 room temperature setpoints according to the time switch program
- Yearly clock
- Holiday and special day program with up to 16 periods
- 7-day program (maximum six switching points per day)
- Time switch programs for heating circuits 1 and 2
- Limitation of the flow temperature
- Automatic heating limit with adjustable limits
- Optimum start control
- Quick setback
- Control of the storage tank temperature with adjustable setpoints for Normal, Reduced, Legionella and Protective mode
- Time switch program for DHW heating
- Demand-compensated boiler temperature control
- Protective boiler startup by reducing the consumer setpoints
- Control of a single-stage or 2-stage burner
- Control of the boiler temperature via modulating burner with DC 0...10 V control
- Burner fault contact

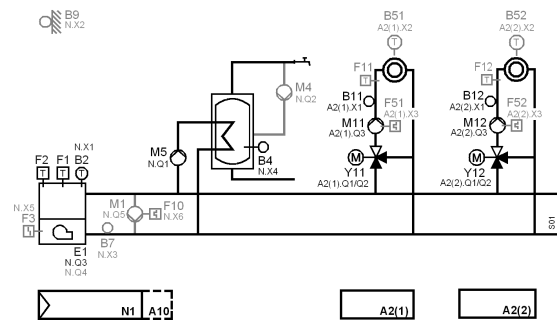

High energy performance
 BACS and TBM

A

To fulfill the classification, the plant must be equipped with all indicated functions.

The indicated energy efficiency classification can be attained only if the following functions are implemented:

- Integrated individual room control including demand control "by occupancy, air quality, etc." (Heating circuits for precontrol in individual room control)
- Indoor temperature control (Room temperature in individual room control via KNX requires extra configuration)
- Variable speed pump control with constant Δp (The pump must have integrated output control)
- enerator; Variable temperature depending on the load

Boiler cascade, 2 boilers with 2-stage burners

RMK770..

K2.2

- Control of the boiler temperature via 2-stage burner
- Control of the shutoff valves
- Common flow and return temperature control
- Control of the main pump

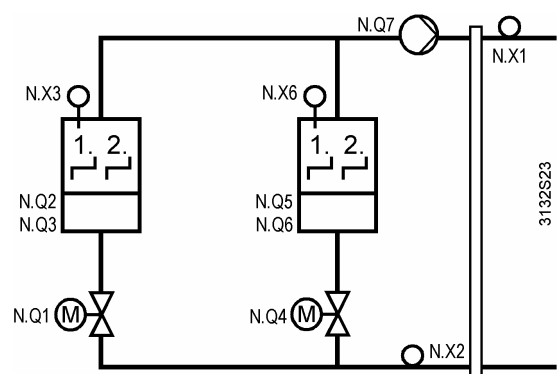

Standard controllers
Communicating HVAC controllers
 Application examples RMH.. / RMK..

RMK770..

K6.2

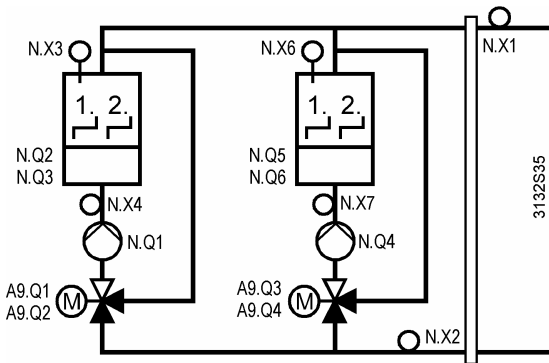

Boiler cascade, 2 boilers with 2-stage burners

- Control of the boiler temperature via 2-stage burner
- Controlled boiler return temperature with 3-port valve and 3-position or DC 0...10 V actuator
- Control of the boiler pumps
- Common flow and return temperature control
- Extension module RMZ789 needed

RMK770..

HFF003 MK7 HQ

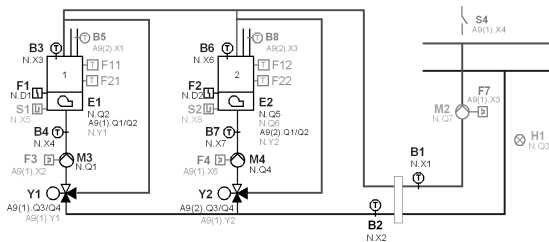

Dual-boiler plant, boiler pumps, boiler return with 3-port valve

- Control of the boiler sequence
- Automatic changeover of lead boiler depending on the number of boiler operating hours
- Control of the boiler pumps
- Control of the boiler temperature via modulating burner with 3-position or DC 0...10 V control
- Burner fault contact
- Limitation of the burner's minimum on time
- Controlled maintained boiler return temperature with 3-port valve and 3-position or DC 0...10 V actuator
- Protective boiler startup
- Maximum and minimum limitation of the boiler temperature
- Selection of boiler operating mode
- Flue gas measuring mode, boiler testing mode
- Burner hours run and burner startup counter
- Minimum and maximum limitation of the flow temperature
- Automatic changeover to summer operation
- (heating OFF)
- Pump overrun, pump kick
- Valve overrun, valve kick
- Acquisition and evaluation of heat requisition signals via Konnex bus

N1
A10
A9(1)
A9(2)

B

To fulfill the classification, the plant must be equipped with all indicated functions.

The indicated energy efficiency classification can be attained only if the following functions are implemented:

In connection with an application that fulfils the energy efficiency class B, necessary for:

- Emission control
- Control of distribution network hot water temperature (supply or return)
- Control of distribution pumps
- Intermittent control of emission and/or distribution

Weather-compensated heating system, district heating connection, 2 heating circuits, d.h.w

RMH760B..

DADC04 H6B HQ

- Weather-compensated flow temperature control with adjustable setpoints for Comfort, Precomfort, Economy and Protective mode
- Frost protection for the building and the plant
- Changeover between 3 room temperature setpoints according to the time switch program
- Yearly clock
- Holiday and special day program with up to [SoftReturn]16 periods
- 7-day program (maximum six switching points [SoftReturn]per day)
- Time switch programs for the heating circuits
- Control of the storage tank charging temperature with adjustable setpoints for Normal, Reduced, Legionella and Protective mode
- Time switch program for DHW heating
- Limitation of the flow temperature
- Automatic heating limit with adjustable limits
- Optimum start control
- Quick setback
- Demand-compensated primary control

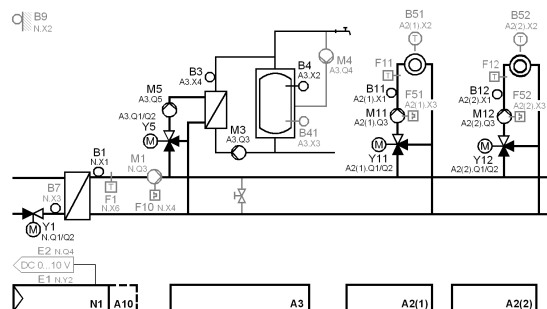

High energy performance
 BACS and TBM

To fulfill the classification, the plant must be equipped with all indicated functions.

The indicated energy efficiency classification can be attained only if the following functions are implemented:

- Integrated individual room control including demand control "by occupancy, air quality, etc." (Heating circuits for precontrol in individual room control)
- Indoor temperature control (Room temperature in individual room control via KNX requires extra configuration)
- Variable speed pump control with constant Δp (The pump must have integrated output control)
- Intermittent control of emission and/or distribution, automatic control with optimum start/stop
- Generator; Variable temperature depending on the load

5

Standard controllers

Communicating HVAC controllers

Application examples RMH.. / RMK..

RMH760B..

DADC04 H6B HQ

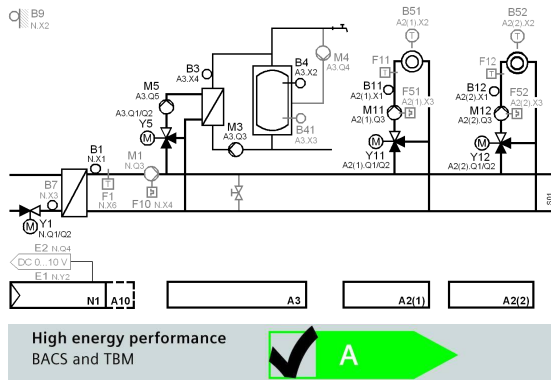

To fulfill the classification, the plant must be equipped with all indicated functions.

Weather-compensated heating system, district heating connection, 2 heating circuits, d.h.w

- Weather-compensated flow temperature control with adjustable setpoints for Comfort, Precomfort, Economy and Protective mode
- Frost protection for the building and the plant
- Changeover between 3 room temperature setpoints according to the time switch program
- Yearly clock
- Holiday and special day program with up to [SoftReturn]16 periods
- 7-day program (maximum six switching points [SoftReturn]per day)
- Time switch programs for the heating circuits
- Control of the storage tank charging temperature with adjustable setpoints for Normal, Reduced, Legionella and Protective mode
- Time switch program for DHW heating
- Limitation of the flow temperature
- Automatic heating limit with adjustable limits
- Optimum start control
- Quick setback
- Demand-compensated primary control

The indicated energy efficiency classification can be attained only if the following functions are implemented:

- Integrated individual room control including demand control "by occupancy, air quality, etc." (Heating circuits for precontrol in individual room control)
- Indoor temperature control (Room temperature in individual room control via KNX requires extra configuration)
- Variable speed pump control with constant Δp (The pump must have integrated output control)
- Intermittent control of emission and/or distribution, automatic control with optimum start/stop
- Generator; Variable temperature depending on the load

Sensors, setpoint adjusters

Product Title	Data sheet	Stock No.	Product No.
Outside sensor LG-Ni1000	N1811	BPZ:QAC22	QAC22
Outside sensor NTC 575 Ohm	N1811	BPZ:QAC32	QAC32
Strap-on temperature sensor LG-Ni1000	N1801	BPZ:QAD22	QAD22
Strap-on temperature sensor with cable LG-Ni1000	N1802	BPZ:QAD26.220	QAD26.220
Immersion temperature sensor 100 mm LG-Ni1000, with protection pocket	N1781	BPZ:QAE2120.010	QAE2120.010
Cable temperature sensor PVC 2 m, LG-Ni1000	N1831	BPZ:QAP22	QAP22
Solar sensor	N1943	BPZ:QLS60	QLS60
Setpoint adjuster, passive, scale 0...50 °C (exchangeable)	N1991	BPZ:BSG21.1	BSG21.1
Flue gas temperature sensor Pt1000	N1846	BPZ:FGT-PT1000	FGT-PT1000

Monitors

Product Title	Data sheet	Stock No.	Product No.
Flow switch for use in hydraulic systems, PN10, DN32...200	N1592	BPZ:QVE1900	QVE1900
Thermal reset limit thermostat	N1202	BPZ:RAK-TW.1..H	RAK-TW.1..H
Temperature limiter	N1206	BPZ:RAK-TB.1..M	RAK-TB.1..M
Safety limit thermostat	N1204	BPZ:RAK-ST..M	RAK-ST..M

Room units

Product Title	Data sheet	Stock No.	Product No.
Room temperature sensor LG-Ni1000	N1721	BPZ:QAA24	QAA24
Room unit with room temperature sensor and setpoint readjuster -3...3 K	N1721	BPZ:QAA27	QAA27
Room temperature sensor LG-Ni1000 for mounting on recessed conduit boxes	N1722	BPZ:QAA64	QAA64
Room unit with KNX bus	N1633	BPZ:QAW740	QAW740

Transformers

Product Title	Data sheet	Stock No.	Product No.
Transformers	N5536	BPZ:SEM62..	SEM62..

Service Interface

Product Title	Data sheet	Stock No.	Product No.
Service tool for KNX / LPB	N5655	BPZ:OCI700.1	OCI700.1
Service interface for USB / KNX	A6V10438951	S55800-Y101	OCI702

NEW PRODUCT

Standard controllers

Communicating HVAC controllers

Universal controllers RMU..

RMU..



Universal controller

- Universal controllers with integrated control and supervisory functions
- Tested, predefined applications (refer to Application Catalog)
- Flexible configuration
- Suited for the controlled variables temperature, relative / absolute humidity, pressure / differential, air flow rate, indoor air quality, etc.
- Autonomous sequence controllers with P, PI or PID mode
- Functions can be extended (extension modules)
- Clear-text operation with separate operator unit (plug-in type or detached)
- Integrated KNX bus communication
- No commissioning tool required

Extension modules complement the Synco 700 universal controllers and offer extra functions. The extension modules are attached to the controller. Full operation from commissioning to enduser operation via the operator unit.

Available extension modules:

- 1 universal module RMZ785
- 2 universal modules RMZ787
- 2 universal modules RMZ788

Total maximal 4 extension modules per RMU7..B can be connected.

Available operator units:

- Plug-in type operator unit RMZ790
- Detached operator unit RMZ791
- Bus operating unit RMZ792

Data sheet	N3150
Operating voltage	AC 24 V
Frequency	50/60 Hz
Power consumption	12 VA
Universal input, signal	LG-Ni1000 2 x LG-Ni1000 T1 (PTC) Pt1000 0...1000 Ohm 1000...1175 Ohm DC 0...10 V Digital pulse contact Potential-free digital status contact
Analog output, signal	DC 0...10 V
Analog output, current	Max. 1 mA
Relay outputs	Potential-free switching contact
Relay output, switching voltage	AC 19...250 V
Relay output, switching current	4 (3) A
Communication	KNX (KNX TP1)
Dimensions (W x H x D)	173 x 90 x 80 mm

Range overview RMU..

Universal inputs, number	Analog outputs, number	Relay outputs, number	Control loops, number	Loaded languages	Stock No.	Product No.
6	2	2	1	de, fr, it, es	BPZ:RMU710B-1	RMU710B-1
6	2	2	1	de, en, fr, nl	BPZ:RMU710B-2	RMU710B-2
6	2	2	1	da, fi, sv, no	BPZ:RMU710B-3	RMU710B-3
6	2	2	1	cs, hu, pl, sk, ru, bg	BPZ:RMU710B-4	RMU710B-4
6	2	2	1	sr, hr, sl, ro, el, tr	BPZ:RMU710B-5	RMU710B-5
6	2	2	1	zh	S55370-C159	RMU710B-6
8	3	4	2	de, fr, it, es	BPZ:RMU720B-1	RMU720B-1
8	3	4	2	de, en, fr, nl	BPZ:RMU720B-2	RMU720B-2
8	3	4	2	da, fi, sv, no	BPZ:RMU720B-3	RMU720B-3
8	3	4	2	cs, hu, pl, sk, ru, bg	BPZ:RMU720B-4	RMU720B-4
8	3	4	2	sr, hr, sl, ro, el, tr	BPZ:RMU720B-5	RMU720B-5
8	3	4	2	zh	S55370-C160	RMU720B-6
8	4	6	3	de, fr, it, es	BPZ:RMU730B-1	RMU730B-1
8	4	6	3	de, en, fr, nl	BPZ:RMU730B-2	RMU730B-2
8	4	6	3	da, fi, sv, no	BPZ:RMU730B-3	RMU730B-3
8	4	6	3	cs, hu, pl, sk, ru, bg	BPZ:RMU730B-4	RMU730B-4
8	4	6	3	sr, hr, sl, ro, el, tr	BPZ:RMU730B-5	RMU730B-5
8	4	6	3	zh	S55370-C161	RMU730B-6



Standard controllers

Communicating HVAC controllers

Application examples RMU..

BACS Energy Performance Classes – EN 15232

High energy performance BACS and TBM	A
Advanced BACS and TBM	B
Standard BACS	C
Non-energy-efficient BACS	D

BACS Building Automation and Control System
TBM Technical Building Management System

Application examples RMU710B..

These are only a few examples of many applications that can be done with the with Synco™700 controllers: RMU710B..

More Synco™700 applications are described in "HIT" (the HVAC project engineering tool with a library of over 300 pre-configured HVAC-applications) and in the RMU710B.. data sheet.

The evaluation of the energy efficiency classification is based on EN15232:2012. For a determination of the energy efficiency classification of the application, please use the "HIT Tool".

Further details are available in the manual "Building automation - impact on energy efficiency" in our HIT Online.

www.siemens.com/hit

RMU710B..

ADA001 U1B HQ

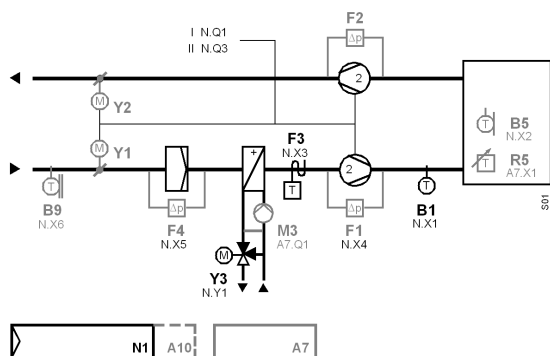

Room-supply air temperature cascade control

- 7-day time switch with holiday / special day program
- Control of a 2-speed fan
- Control of the supply air temperature via the heating coil valve
- Frost protection with frost protection monitor
- Supervision of the supply and extract air fans with differential pressure sensors
- Supervision of the supply air filter with a differential pressure sensor

RMU710B..

ADB001 U1B HQ

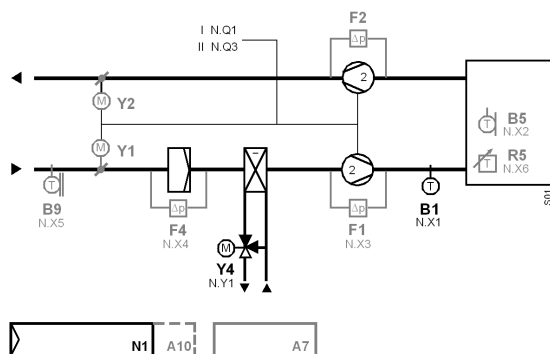

Room-supply air temperature cascade control

- 7-day time switch with holiday / special day program
- Control of a 2-speed fan
- Control of the supply air temperature via the cooling coil valve
- Supervision of the supply and extract air fans with differential pressure sensors
- Supervision of the supply air filter with a differential pressure sensor

The indicated energy efficiency classification can be attained only if the following functions are implemented:

- Air flow control at the room level on demand (Air quality sensor must be integrated as an additional feature)
- Air flow control at the air handler level (Automatic fan step switching corresponds to Efficiency Class B / Step 2 must be switched based on air quality)
- Free mechanical cooling (Outside air temperature and room temperature sensor required)
- Supply temperature control, variable set point with load dependant compensation
- Humidity control (Not applicable, as no humidity control)

Advanced
BACS and TBM

B

To fulfill the classification, the plant must be equipped with all indicated functions.

Room-supply air temperature cascade control

RMU710B..

ADC001 U1B HQ

- 7-day time switch with holiday / special day program
- Control of a 2-speed fan
- Control of the supply air temperature via the heating coil valve and the cooling coil valve in sequence
- Frost protection with frost protection monitor
- Supervision of the supply and extract air fans with differential pressure sensors
- Supervision of the supply air filter with a differential pressure sensor

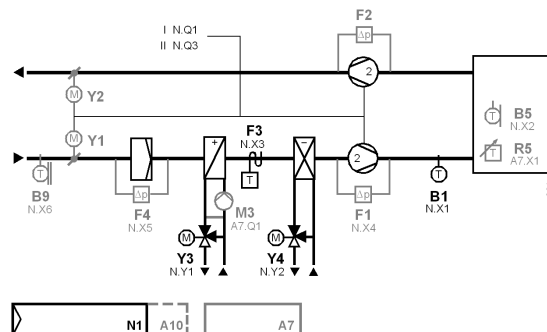

Room-supply air temperature cascade control

RMU710B..

AEA001 U1B DE

- 7-day time switch with holiday / special day program
- Control of a variable-speed fan
- Control of the supply air temperature via the mixed air dampers and the heating coil valve in sequence
- Frost protection with frost protection monitor
- Supervision of the supply and extract air fans with differential pressure sensors
- Supervision of the supply air filter with a differential pressure sensor

The indicated energy efficiency classification can be attained only if the following functions are implemented:

- Air flow control at the room level, demand control
- Air flow control at the air handler level, automatic flow or pressure control with or without pressure reset
- With heat exchanger overheating control
- Free mechanical cooling (Not applicable due to lack of cooling sequence)
- Humidity control (Not applicable, as no humidity control)
- Home automation / building automation and control system and technical home/building management required satisfying Efficiency Class A

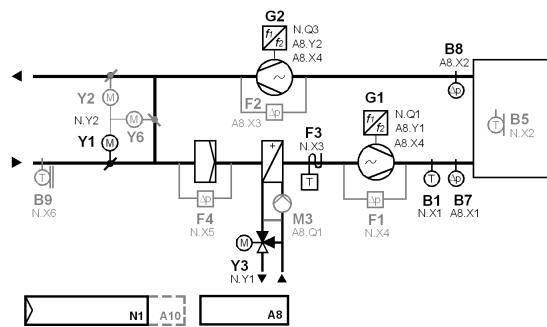

High energy performance
 BACS and TBM

To fulfill the classification, the plant must be equipped with all indicated functions.



Standard controllers
Communicating HVAC controllers
Application examples RMU..

RMU710B..

ADAE01 U1B HQ

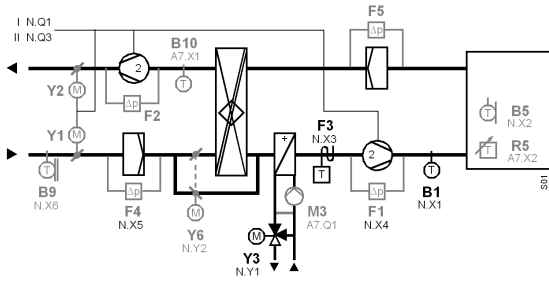

N1 A10 A7

Advanced
 BACS and TBM

B

To fulfill the classification, the plant must be equipped with all indicated functions.

Room-supply air temperature cascade control

- 7-day time switch with holiday / special day program
- Control of a 2-speed fan
- Control of the supply air temperature via the heat recovery system and the heating coil valve in sequence
- Frost protection with frost protection monitor
- Supervision of the supply and extract air fans with differential pressure sensors
- Supervision of the supply and extract air filters with differential pressure sensors

The indicated energy efficiency classification can be attained only if the following functions are implemented:

- Air flow control at the room level, demand control (Air quality sensor must be integrated as an additional feature)
- Air flow control at the air handler level, automatic flow or pressure control with or without pressure reset (Automatic fan step switching corresponds to Efficiency Class B / Step 2 must be switched based on air quality)
- Heat exchanger defrost control (Exhaust air temperature sensor required)
- Heat exchanger overheating control
- Supply Temperature control (Variable set point with load dependant compensation)

Application examples RMU720B..

These are only a few examples of many applications that can be done with the Synco™700 controllers: RMU720B.. More Synco™700 applications are described in "HIT" (the HVAC project engineering tool with a library of over 300 pre-configured HVAC-applications) and in the RMU720B.. data sheet.

The evaluation of the energy efficiency classification is based on EN15232:2012. For a determination of the energy efficiency classification of the application, please use the "HIT Tool". Further details are available in the manual "Building automation - impact on energy efficiency" in our HIT Online.

www.siemens.com/hit

BACS Energy Performance Classes – EN 15232

High energy performance BACS and TBM	A
Advanced BACS and TBM	B
Standard BACS	C
Non-energy-efficient BACS	D

BACS Building Automation and Control System
 TBM Technical Building Management System

5

Room-supply air temperature cascade control

RMU720B..

AEC001 U2B DE

- 7-day time switch with holiday / special day program
- Control of a variable-speed fan
- Control of the supply air temperature via the mixed air dampers, the heating coil valve and cooling coil valve in sequence
- Frost protection with frost protection monitor
- Supervision of the supply and extract air fans with differential pressure sensors
- Supervision of the supply air filter with a differential pressure sensor
- Home automation / building automation and control system and technical home/building management required satisfying Efficiency Class A

The indicated energy efficiency classification can be attained only if the following functions are implemented:

- Air flow control at the room level, demand control
- Air flow control at the air handler level, automatic flow or pressure control with or without pressure reset
- With heat exchanger overheating control
- Free mechanical cooling (Outside air temperature and room temperature sensor required)
- Supply temperature control, variable set point with load dependant compensation

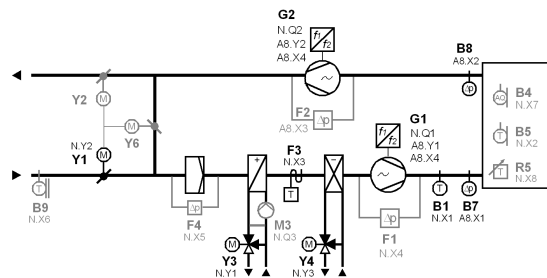

N1 A10 A8

High energy performance
 BACS and TBM

A

To fulfill the classification, the plant must be equipped with all indicated functions.



Room-supply air temperature cascade control

RMU720B..

ADCE01 U2B HQ

- 7-day time switch with holiday / special day program
- Control of a 2-speed fan
- Control of the supply air temperature via the heating coil valve and the cooling coil valve in sequence
- Frost protection with the frost protection monitor
- Supervision of the supply and extract air fans with differential pressure sensors
- Supervision of the supply and extract air filter with a differential pressure sensor

The indicated energy efficiency classification can be attained only if the following functions are implemented:

- Air flow control at the room level, demand control (Air quality sensor must be integrated as an additional feature)
- Air flow control at the air handler level, automatic flow or pressure control with or without pressure reset (Automatic fan step switching corresponds to Efficiency Class B / Step 2 must be switched based on air quality)
- Heat exchanger defrost control (Exhaust air temperature sensor required)
- With heat exchanger overheating control
- Free mechanical cooling (Outside air temperature and room temperature sensor required)
- Supply Temperature control, variable set point with load dependant compensation

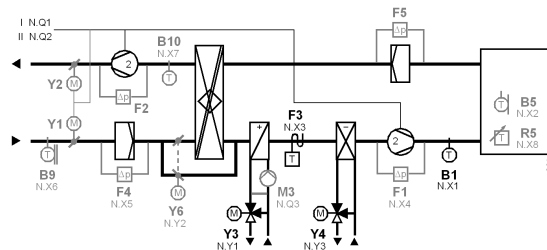

N1 A10 A7

Advanced
 BACS and TBM

B

To fulfill the classification, the plant must be equipped with all indicated functions.

Standard controllers

Communicating HVAC controllers

Application examples RMU..

RMU720B..

ADFB01 U2B HQ

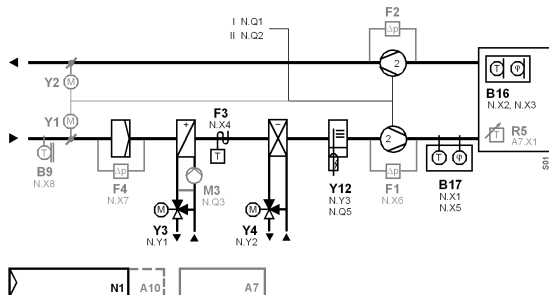

Room-supply air temperature cascade and humidity control

- 7-day time switch with holiday / special day program
- Control of a 2-speed fan
- Control of the supply air temperature via the heating coil valve and cooling coil valve in sequence
- Control of room humidity via the air humidifier (on command and modulating positioning signal)
- Frost protection with frost protection monitor
- Supervision of the supply and extract air fans with differential pressure sensors
- Supervision of the supply air filter with differential pressure sensors
- Limitation of supply air humidity

RMU720B..

AEDB01 U2B HQ

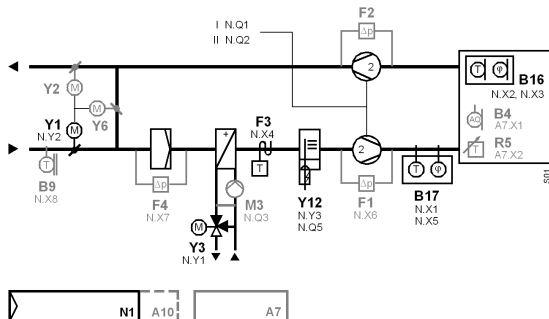

Room-supply air temperature cascade and humidity control

- 7-day time switch with holiday / special day program
- Control of a 2-speed fan
- Control of the supply air temperature via the mixed air dampers and the heating coil valve in sequence
- Control of room humidity via the air humidifier (on command and modulating positioning signal)
- Frost protection with frost protection monitor
- Supervision of the supply and extract air fans with differential pressure sensors
- Supervision of the supply air filter with a differential pressure sensor
- Limitation of supply air humidity

The indicated energy efficiency classification can be attained only if the following functions are implemented:

- Air flow control at the room level, demand control (Air quality sensor required)
- Air flow control at the air handler level, automatic flow or pressure control with or without pressure reset (Automatic fan step switching corresponds to Efficiency Class B / Step 2 must be switched based on air quality)
- With heat exchanger overheating control
- Supply Temperature control, variable set point with load dependant compensation
- Room or exhaust air humidity control

5

Advanced BACS and TBM 

To fulfill the classification, the plant must be equipped with all indicated functions.

Room-supply air temperature cascade and humidity control

RMU720B..

ADDP01 U2B HQ

- 7-day time switch with holiday / special day program
- Control of a 2-speed fan
- Control of the supply air temperature via the heat recovery system and the heating coil valve in sequence
- Control of room humidity via the air humidifier (on command and modulating positioning signal)
- Frost protection with frost protection monitor
- Supervision of the supply and extract air fans with differential pressure sensors
- Supervision of the supply and extract air filters with differential pressure sensors
- Limitation of supply air humidity

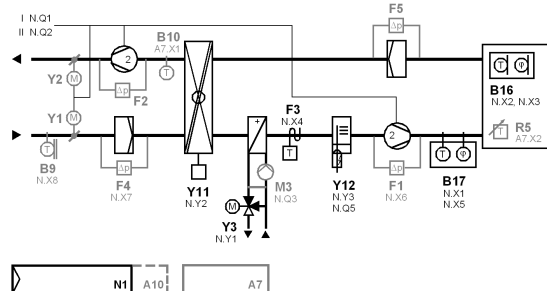

Advanced BACS and TBM 

The indicated energy efficiency classification can be attained only if the following functions are implemented:

- Air flow control at the room level, demand control (Air quality sensor must be integrated as an additional feature)
- Air flow control at the air handler level, automatic flow or pressure control with or without pressure reset (Automatic fan step switching corresponds to Efficiency Class B / Step 2 must be switched based on air quality)
- Heat exchanger defrost control (Exhaust air temperature sensor required)
- With heat exchanger overheating control
- Supply Temperature control, variable set point with load dependant compensation
- Room or exhaust air humidity control



To fulfill the classification, the plant must be equipped with all indicated functions.

Application examples RMU730B..

These are only a few examples of many applications that can be done with the with Synco™700 controllers: RMU730B..
 More Synco™700 applications are described in "HIT" (the HVAC project engineering tool with a library of over 300 pre-configured HVAC-applications) and in the RMU730B.. data sheet.

The evaluation of the energy efficiency classification is based on EN15232:2012. For a determination of the energy efficiency classification of the application, please use the "HIT Tool".
 Further details are available in the manual "Building automation - impact on energy efficiency" in our HIT Online.
www.siemens.com/hit

BACS Energy Performance Classes – EN 15232

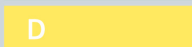
High energy performance BACS and TBM	
Advanced BACS and TBM	
Standard BACS	
Non-energy-efficient BACS	

BACS Building Automation and Control System
 TBM Technical Building Management System

Standard controllers

Communicating HVAC controllers

Application examples RMU..

RMU730B..

AEFB01 U3B HQ

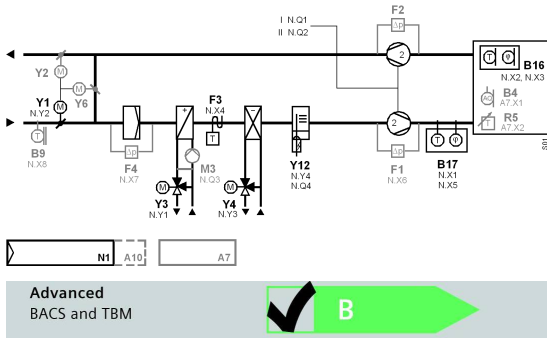

To fulfill the classification, the plant must be equipped with all indicated functions.

Room-supply air temperature cascade and humidity control

- 7-day time switch with holiday / special day program
- Control of a 2-speed fan
- Control of the supply air temperature via the mixed air dampers, the heating coil valve and cooling coil valve in sequence
- Control of room humidity via the air humidifier (on command and modulating positioning signal)
- Frost protection with frost protection monitor
- Supervision of the supply and extract air fans with differential pressure sensors
- Supervision of the supply air filter with a differential pressure sensor
- Limitation of supply air humidity

The indicated energy efficiency classification can be attained only if the following functions are implemented:

- Air flow control at the room level, demand control (Air quality sensor required)
- Air flow control at the air handler level, automatic flow or pressure control with or without pressure reset (Automatic fan step switching corresponds to Efficiency Class B / Step 2 must be switched based on air quality)
- With heat exchanger overheating control
- Free mechanical cooling (Outside air temperature and room temperature sensor required)
- Supply Temperature control, variable set point with load dependant compensation
- Room or exhaust air humidity control

RMU730B..

ADFP01 U3B HQ

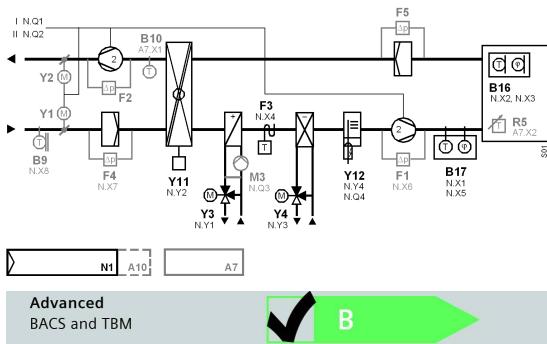

To fulfill the classification, the plant must be equipped with all indicated functions.

Room-supply air temperature cascade and humidity control

- 7-day time switch with holiday / special day program
- Control of a 2-speed fan
- Control of the supply air temperature via the heat recovery system, the heating coil valve and cooling coil valve in sequence
- Control of room humidity via the air humidifier (on command and modulating positioning signal)
- Frost protection with frost protection monitor
- Supervision of the supply and extract air fans with differential pressure sensors
- Supervision of the supply and extract air filters with differential pressure sensors
- Limitation of the supply air humidity

The indicated energy efficiency classification can be attained only if the following functions are implemented:

- Air flow control at the room level, demand control (Air quality sensor must be integrated as an additional feature)
- Air flow control at the air handler level, automatic flow or pressure control with or without pressure reset (Automatic fan step switching corresponds to Efficiency Class B / Step 2 must be switched based on air quality)
- Heat exchanger defrost control (Exhaust air temperature sensor required)
- With heat exchanger overheating control
- Free mechanical cooling (Outside air temperature and room temperature sensor required)
- Supply Temperature control, variable set point with load dependant compensation
- Room or exhaust air humidity control

Room-supply air temperature cascade and humidity control

RMU730B..

ADZA01 U3B HQ

- 7-day time switch with holiday / special day program
- Control of a 2-speed fan
- Room (extract air)-supply air temperature cascade control with minimum and maximum limitation of the supply air temperature
- Control of the supply air temperature via the reheater valve and the cooling coil valve in sequence
- Control of the dewpoint temperature via the preheater valve and the cooling coil valve in sequence
- Control of room humidification via the air humidifier (on command)
- Control of room dehumidification by changing the outputs of dewpoint temperature control
- Frost protection with frost protection monitor
- Supervision of the supply and extract air fans with differential pressure sensors
- Supervision of the supply air filter with a differential pressure sensor
- Limitation of supply air humidity by shutting down the preheater and by switching off the air humidifier in sequence

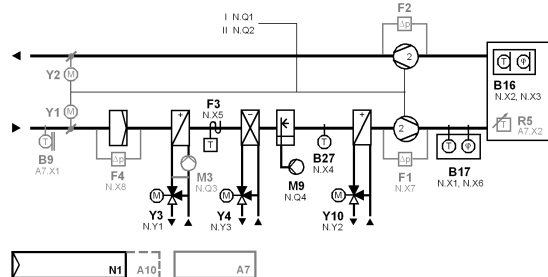

Room-supply air temperature cascade and humidity control

RMU730B..

AEZH01 U3B DE

- 7-day time switch with holiday / special day program
- Control of variable speed fan
- Room (extract air)-supply air temperature cascade control with minimum and maximum limitation of the supply air temperature
- Control of the supply air temperature via the mixed air dampers, the reheater valve and cooling coil valve in sequence
- Control of the dewpoint temperature via the mixed air dampers, the preheater valve and cooling coil valve in sequence
- Control of room humidification via the air humidifier (on command)
- Control of room dehumidification by changing the outputs of dewpoint temperature control
- Frost protection with frost protection monitor
- Supervision of the supply and extract air fans with differential pressure sensors
- Supervision of the supply air filter with a differential pressure sensor
- Limitation of supply air humidity

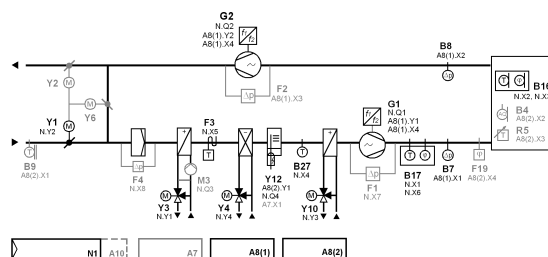

High energy performance
 BACS and TBM

To fulfill the classification, the plant must be equipped with all indicated functions.

The indicated energy efficiency classification can be attained only if the following functions are implemented:

- Air flow control at the room level, demand control
- Air flow control at the air handler level, automatic flow or pressure control with or without pressure reset
- With heat exchanger overheating control
- Free mechanical cooling
- Supply Temperature control, variable set point with load dependant compensation
- Room or exhaust air humidity control
- Home automation / building automation and control system and technical home/building management required satisfying Efficiency Class A



Standard controllers

Communicating HVAC controllers

Application examples RMU..

RMU730B..

AEZH02 U3B HQ

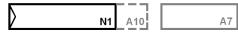
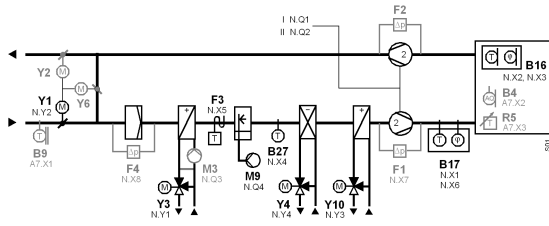

Advanced
BACS and TBM



To fulfill the classification, the plant must be equipped with all indicated functions.

Room-supply air temperature cascade and humidity control

- 7-day time switch with holiday / special day program
- Control of a 2-speed fan
- Room (extract air)-supply air temperature cascade control with minimum and maximum limitation of the supply air temperature
- Control of the supply air temperature via the mixed air dampers, the reheater valve and the cooling coil valve in sequence
- Control of the dewpoint temperature via the mixed air dampers and the pre-heater valve in sequence
- Control of room humidification via the air humidifier (on command) and the cooling coil valve in sequence
- Frost protection with frost protection monitor
- Supervision of the supply and extract air fans with differential pressure sensors
- Supervision of the supply air filter with a differential pressure sensor
- Limitation of supply air humidity by switching off the air humidifier in sequence

The indicated energy efficiency classification can be attained only if the following functions are implemented:

- Air flow control at the room level, demand control (Air quality sensor required)
- Air flow control at the air handler level, automatic flow or pressure control with or without pressure reset (Automatic fan step switching corresponds to Efficiency Class B / Step 2 must be switched based on air quality)
- With heat exchanger overheating control
- Free mechanical cooling (Outside air temperature and room temperature sensor required)
- Supply Temperature control, variable set point with load dependant compensation
- With supply air humidity control

RMS705B..



Switching and monitoring device

In connection with the function blocks, the RMS705B complements the range of Synco700 products as a freely configurable unit for

- control and supervisory functions in heating, ventilation and refrigeration plant
- non-standard applications

and, for this reason, offers no predefined standard applications.

The RMS705B is especially suited for the following functions:

- Connection of additional universal alarm inputs
- Adding free inputs for display and supervision
- Event logging (e.g. legionella function)
- Additional time programs (ON / OFF) for basic functions
- Maximum and minimum selection
- Calculation of average
- Calculation of enthalpy, enthalpy differential, absolute humidity, dewpoint and wet bulb temperature
- Logic function blocks for switching on / off depending on different conditions
- Lead / lag control of pumps, fans, motors, chillers, etc., with automatic changeover
- Step switch with linear, binary or flexible functionality
- Autonomous sequence controllers with P, PI or PID mode

Available extension modules:

- 1 universal module RMZ785
- 2 universal modules RMZ787
- 2 universal modules RMZ788

Total maximal 4 extension modules per RMS705B can be connected.

Suitable types of operator units:

- Plug-in operator unit type RMZ790
- Detached operator unit type RMZ791
- Bus operating unit type RMZ792

Data sheet	N3124
Operating voltage	AC 24 V
Frequency	50/60 Hz
Power consumption	12 VA
Universal inputs, number	8
Universal input, signal	LG-Ni1000 2 x LG-Ni1000 T1 (PTC) Pt1000 0...1000 Ohm DC 0...10 V Digital pulse contact Potential-free digital status contact
Analog outputs, number	4
Analog output, signal	DC 0...10 V
Analog output, current	Max. 1 mA
Relay outputs, number	6
Relay outputs	Potential-free switching contact
Relay output, switching voltage	AC 19...250 V
Relay output, switching current	4 (3) A
Communication	KNX (KNX TP1)
Degree of protection	IP20
Dimensions (W x H x D)	173 x 90 x 80 mm

Standard controllers

Communicating HVAC controllers

Switching and monitoring device RMS..

Range overview RMS705B..

Product Title	Data sheet	Stock No.	Product No.
Switching and monitoring device with languages de, fr, it, es, pt	N3124	S55370-C100	RMS705B-1
Switching and monitoring device with languages de, fr, nl, en	N3124	S55370-C101	RMS705B-2
Switching and monitoring device with languages da, fi, no, sv	N3124	S55370-C102	RMS705B-3
Switching and monitoring device with languages pl, cs, hu, ru, sk, bg	N3124	S55370-C103	RMS705B-4
Switching and monitoring device with languages el, ro, sl, sr, hr, tr	N3124	S55370-C104	RMS705B-5
Switching and monitoring device with language zh	N3124	S55370-C105	RMS705B-6

Standard controllers
Communicating HVAC controllers
Extension modules and operator units for RMU.. and RMS..

Plug-in type operator unit

RMZ790

- Operator unit plugs into the Synco™ 700 controllers
- For displaying and changing plant data for service staff and enduser
- Clear-text operation
- Can be plugged in and removed during operation
- Power supply via the controller



Data sheet N3111

	Stock No.	Product No.
	BPZ:RMZ790	RMZ790

Detached operator unit with 3 m cable

RMZ791

- Like plug-in type operator unit, but:
- Other mounting choices (typically for control panel door or wall mounting)
 - Larger display
 - Connection via a prefabricated 3 m cable, supplied as standard



Data sheet N3112

	Stock No.	Product No.
	BPZ:RMZ791	RMZ791

Bus operator unit

RMZ792

Communicating operator unit for operating up to 150 controllers, room units and central units from the Synco™ 700 range via KNX bus.
 Favorite pages can be freely defined. Designed for fixed installation or mobile use.



Data sheet N3113



	Stock No.	Product No.
	BPZ:RMZ792	RMZ792

Universal modules

RMZ78..

Additional inputs and outputs required by the Synco™ 700 controllers can be provided by these modules. A description of the functions is given with the relevant controller module.

Data sheet N3146

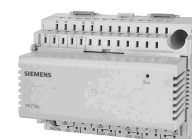

Voltage supply	Supply from controller module
Power consumption	2 VA
Universal input, signal	0...1000 Ohm
	1000...1175 Ohm
	2 x LG-Ni1000
	DC 0...10 V
	Potential-free digital status contact
	LG-Ni1000
	Pt1000
	T1 (PTC)
Analog output, signal	DC 0...10 V
Analog output, current	Max. 1 mA
Relay outputs	switching contact, potential-free
Relay output, switching voltage	AC 19...265 V
Relay output, switching current	4 (3) A

Standard controllers

Communicating HVAC controllers

Extension modules and operator units for RMU.. and RMS..

Range overview RMZ78..

Universal inputs, number	Analog outputs, number	Relay outputs, number	Stock No.	Product No.
8	0	0	BPZ:RMZ785	RMZ785
4	0	4	BPZ:RMZ787	RMZ787
4	2	2	BPZ:RMZ788	RMZ788

RMZ780



Module connector

Module connector for detached mounting of extension modules within the control panel.
Distance for detached mounting: Maximum 10 m.

Data sheet

N3138

Stock No.

Product No.

BPZ:RMZ780

RMZ780

Sensors, setpoint adjusters

Product Title	Data sheet	Stock No.	Product No.
Outside sensor LG-Ni1000	N1811	BPZ:QAC22	QAC22
Outside / room temperature sensor DC 0..10V	N1814	BPZ:QAC3161	QAC3161
Strap-on temperature sensor LG-Ni1000	N1801	BPZ:QAD22	QAD22
Strap-on temperature sensor with cable LG-Ni1000	N1802	BPZ:QAD26.220	QAD26.220
Immersion temperature sensor 100 mm LG-Ni1000, with protection pocket	N1781	BPZ:QAE2120.010	QAE2120.010
Immersion temperature sensor 150 mm, LG-Ni1000, with protection pocket	N1781	BPZ:QAE2120.015	QAE2120.015
Immersion temperature sensor 100 mm, LG-Ni1000, without protection pocket	N1781	BPZ:QAE2121.010	QAE2121.010
Immersion temperature sensor 150 mm LG-Ni1000, without protection pocket	N1781	BPZ:QAE2121.015	QAE2121.015
Immersion temperature sensor 100 mm DC 0...10 V	N1782	BPZ:QAE2164.010	QAE2164.010
Immersion temperature sensor 150 mm DC 0...10 V	N1782	BPZ:QAE2164.015	QAE2164.015
Immersion temperature sensor Ø 4 mm with cable and fitting	N1790	BPZ:QAE26.9..	QAE26.9..
Duct temperature sensor 400 mm, Pt1000	N1761	BPZ:QAM2112.040	QAM2112.040
Duct temperature sensor 400 mm, LG-Ni1000	N1761	BPZ:QAM2120.040	QAM2120.040
Duct temperature sensor 2000 mm, LG-Ni1000	N1761	BPZ:QAM2120.200	QAM2120.200
Duct temperature sensor 6000 mm, LG-Ni1000	N1761	BPZ:QAM2120.600	QAM2120.600
Frost detector, modulating, capillary tube 2000 mm	A6V10432020	S55700-P153	QAF63.2-J
Frost detector, modulating, capillary tube 6000 mm	A6V10432020	S55700-P154	QAF63.6-J
Frost detector, modulating and 2-point, capillary tube 2000 mm	A6V10432022	S55700-P155	QAF64.2-J
Frost detector, modulating and 2-point, capillary tube 6000 mm	A6V10432022	S55700-P156	QAF64.6-J
Cable temperature sensor for high-temperature applications (180°C)	N1833	BPZ:QAP21.2	QAP21.2
Cable temperature sensor silicone 1.5 m, LG-Ni1000	N1831	BPZ:QAP21.3	QAP21.3
Cable temperature sensor PVC 2 m, LG-Ni1000	N1831	BPZ:QAP22	QAP22
Window pane temperature sensor	N1830	BPZ:QAT22	QAT22
Solar sensor	N1943	BPZ:QLS60	QLS60
Differential pressure sensor for liquids and gases	N1923	BPZ:QBE61.3-DP..	QBE61.3-DP..
Differential pressure sensors for liquids and gas (DC 0...10 V)	N1920	BPZ:QBE63-DP..	QBE63-DP..
Differential pressure sensor for liquids and gases (DC 0...10 V) 0...400 kPa	N1921	BPZ:QBE64-DP4	QBE64-DP4
Pressure sensor for neutral and slightly aggressive liquids and gases (0...10 V)	A6V10432494	BPZ:QBE2003-P..	QBE2003-P..
Pressure sensor for refrigerants (0...10 V)	A6V10434676	BPZ:QBE2004-P..U	QBE2004-P..U

Standard controllers

Communicating HVAC controllers

Field devices for RMU.. and RMS..

Sensors, setpoint adjusters

Product Title	Data sheet	Stock No.	Product No.
Air duct differential pressure sensor, DC 0...10 V	N1916_01	BPZ:QBM3020..	QBM3020..
Differential pressure sensor, DC 0...10 V	N1910_01	BPZ:QBM2030..	QBM2030..
Duct sensor for humidity (DC 0...10 V)	N1864	BPZ:QFM2100	QFM2100
Duct sensor for humidity (0...10 V) and temperature (Ni1000)	N1864	BPZ:QFM2120	QFM2120
Duct sensor for humidity (DC 0...10 V) and temperature (DC 0...10 V)	N1864	BPZ:QFM2160	QFM2160
Duct sensor for humidity (DC 0...10 V) for demanding requirements	N1882	BPZ:QFM3100	QFM3100
Duct sensor for humidity (DC 0...10 V) and temperature (DC 0...10 V) for demanding requirements	N1882	BPZ:QFM3160	QFM3160
Duct sensor for humidity (0...10 V) and temperature (0...10 V) with calibration certificate	N1883	BPZ:QFM4160	QFM4160
Duct air quality sensor CO ₂ / temperature / rel. Humidity / VOC	N1962	BPZ:QPM21..	QPM..
Setpoint adjuster, passive, scale 0...50 °C (exchangeable)	N1991	BPZ:BSG21.1	BSG21.1
Setpoint adjuster, passive, temperature ranges: -20...20 °C; 20...60 °C; -3...3 K	N1991	BPZ:BSG21.5	BSG21.5
Active setpoint adjuster 0...100 %, for flush panel mounting	N1992	BPZ:BSG61	BSG61
Flue gas temperature sensor Pt1000	N1846	BPZ:FGT-PT1000	FGT-PT1000
Duct sensor for air velocity	N1932	BPZ:QVM62.1	QVM62.1

Monitors

Product Title	Data sheet	Stock No.	Product No.
Frost detector, air side, 2-point	A6V10432022	BPZ:QAF64..J	QAF64..J
Frost monitor, 2-point	N1284	BPZ:QAF81..	QAF81..
Room hygrostat, setpoint setting range 30...90 % r.h., setpoint adjuster inside device	N1518	BPZ:QFA1000	QFA1000
Room hygrostat, setpoint setting range 30...90 % r.h., external setpoint adjustment	N1518	BPZ:QFA1001	QFA1001
Duct hygrostat, setpoint setting range 15...95 % r.h.	N1514	BPZ:QFM81.2	QFM81.2
Room hygrostat, setpoint setting range 15...95 % r.h., setpoint adjuster inside device	N1514	BPZ:QFM81.21	QFM81.21
Condensation monitor, AC/DC 24 V	N3302	S55770-T325	QXA2601
Condensation monitor, AC/DC 24 V, with remote sensor head (cable length 1.5 m)	N3302	S55770-T326	QXA2602
Differential pressure monitor	N1552	BPZ:QBM81..	QBM81..
Flow switch for use in hydraulic systems, PN25, DN20...200	N1594	BPZ:QVE1901	QVE1901
Temperature controller	N1205	BPZ:RAK-TR.1..H	RAK-TR.1..H
Thermal reset limit thermostat	N1202	BPZ:RAK-TW.1..H	RAK-TW.1..H
Temperature limiter	N1206	BPZ:RAK-TB.1..M	RAK-TB.1..M
Safety limit thermostat	N1204	BPZ:RAK-ST..M	RAK-ST..M
Temperature controller / thermal reset limit thermostat	N1191	BPZ:RAZ-TW.1..	RAZ-TW.1..
Temperature controller / safety limit thermostat	N1192	BPZ:RAZ-ST..	RAZ-ST..
Changeover thermostat, changeover, 30 °C / 19 °C, IP54	N1295	BPZ:RYT182	RYT182



NEW PRODUCT

Standard controllers

Communicating HVAC controllers

Field devices for RMU.. and RMS..

Room units

Product Title	Data sheet	Stock No.	Product No.
Room temperature sensor LG-Ni1000	N1721	BPZ:QAA24	QAA24
Room unit with room temperature sensor and setpoint adjuster	N1721	BPZ:QAA25	QAA25
Room unit with room temperature sensor and setpoint readjuster -3...3 K	N1721	BPZ:QAA27	QAA27
Room temperature sensor LG-Ni1000 for mounting on recessed conduit boxes	N1722	BPZ:QAA64	QAA64
Room unit with KNX bus	N1633	BPZ:QAW740	QAW740
Room sensor for humidity (DC 0...10 V)	N1857	BPZ:QFA2000	QFA2000
Room sensor for humidity (DC 0...10 V) and temperature (LG-Ni1000)	N1857	BPZ:QFA2020	QFA2020
Room sensor for humidity (DC 0...10 V) and temperature (DC 0...10 V)	N1857	BPZ:QFA2060	QFA2060
Room sensor for humidity (DC 0...10 V) for demanding requirements	N1858	BPZ:QFA3100	QFA3100
Room sensor for humidity (DC 0...10 V) and temperature (DC 0...10 V) for demanding requirements	N1858	BPZ:QFA3160	QFA3160
Room sensor for humidity (DC 0...10V) and temperature (DC 0...10V) with calibration certificate	N1859	BPZ:QFA4160	QFA4160
Indoor air quality controller with integrated VOC sensor for mixed gas	N1571	BPZ:QPA84	QPA84
Room air quality sensor CO ₂ / temperature / rel. Humidity / VOC	N1961	BPZ:QPA20..	QPA..

Step switches, signal converters and transformers

Product Title	Data sheet	Stock No.	Product No.
Variable Speed Drive for pumps and fans	N5111	BPZ:G120P..	G120P..
Transformers	N5536	BPZ:SEM62..	SEM62..
Current valve	N4937	BPZ:SEA45.1	SEA45.1
Signal converter DC 0...10 V or DC 0 / 10 V in AC 0 / 24 V	N5102	BPZ:SEM61.4	SEM61.4
Signal converter with preprogrammed applications	N5146	BPZ:SEZ220	SEZ220
Universal digital indicator	N5312	BPZ:BAU200	BAU200

Service Interface

Product Title	Data sheet	Stock No.	Product No.
Service tool for KNX / LPB	N5655	BPZ:OCI700.1	OCI700.1
Service interface for USB / KNX	A6V10438951	S55800-Y101	OCI702

Standard controllers
Software and central communication units
For web and remote operation via KNX: OZW77..

Standard systems main components

The Synco standard system consists of the following main components:

Product Title	Data sheet	Stock No.	Product No.
Commissioning and plant operating software	N5649	S55800-Y100	ACS790
Central communication unit OZW771..	N3117	BPZ:OZW771..	OZW771..
Web server for Synco devices	N5701	BPZ:OZW772..	OZW772..
Heating controller	N3133	BPZ:RMH760B..	RMH760B..
Boiler sequence controller	N3132	BPZ:RMK770..	RMK770..
Universal controller	N3150	BPZ:RMUB..	RMU..
Switching and monitoring device	N3124	BPZ:RMS705B..	RMS705B..
Central control unit RMB795B for room controllers and room thermostats	N3122	BPZ:RMB795B..	RMB795B..
Room unit with KNX bus	N1633	BPZ:QAW740	QAW740
Room controller for 3-speed fan	N3873	BPZ:RXB21.1/FC-10	RXB21.1/FC-10
Room controller for 3-speed fan	N3873	BPZ:RXB21.1/FC-11	RXB21.1/FC-11
Room controller with 3-speed fan and electric heating coil	N3873	BPZ:RXB22.1/FC-12	RXB22.1/FC-12
Room controller for chilled ceilings and radiators	N3874	BPZ:RXB24.1/CC-02	RXB24.1/CC-02
Room controller for fan-coil applications with KNX communication	N3875	S55373-C121	RXB39.1/FC-13



Standard controllers

Software and central communication units

For web and remote operation via KNX: OZW77..

Standard systems main components

The Synco standard system consists of the following main components:

Product Title	Data sheet	Stock No.	Product No.
Room controller for 3-speed fan	N3877	BPZ:RXL21.1/FC-10	RXL21.1/FC-10
Room controller for 3-speed fan	N3877	BPZ:RXL21.1/FC-11	RXL21.1/FC-11
Room controller with 3-speed fan and electric heating coil	N3877	BPZ:RXL22.1/FC-12	RXL22.1/FC-12
Room controller for chilled ceilings and radiators	N3878	BPZ:RXL24.1/CC-02	RXL24.1/CC-02
Communicating room controller for fan-coil applications with proprietary communication	N3876	S55373-C122	RXL39.1/FC-13
Flush-mount room thermostat with KNX communications, 2-/4-pipe fan coils or DX type equipment	N3171	S55770-T104	RDF301
Flush-mount room thermostat with KNX communications, 2-/4-pipe fan coils or DX type equipment, four buttons for switching lights and blinds	N3171	S55770-T105	RDF301.50
Hotel Flush-mount room thermostat with KNX, 2-/4-pipe fan coils or DX type equipment, four buttons hotel functions	N3171	S55770-T334	RDF301.50H
Touch screen room thermostat with KNX communications, for 2-/4-pipe fan coil, universal applications or compressors in DX-type equipment	N3174	S55770-T350	RDF800KN
Touch screen room thermostat with KNX communications, for 2-/4-pipe fan coil, universal applications or compressors in DX-type equipment (for China frames)	N3174	S55770-T335	RDF800KN/NF
Flush-mount room thermostat with KNX communications, 2-/4-pipe fan coils or DX type equipment	N3171	S55770-T293	RDF600KN
Room thermostat with KNX communications, AC 230 V, for fan coil units and universal applications	N3191	S55770-T163	RDG100KN
Room thermostat with KNX communications, AC 24 V, for fan coil units and universal applications, heat pump, fan (1-/3-speed, DC), valves (2-point, DC)	N3191	S55770-T297	RDG160KN
Room thermostat with KNX communications, AC 24 V, VAV heating and cooling systems	N3192	S55770-T165	RDG400KN
Semi Flush-mount room thermostat for rectangular conduit box with KNX communications, for VAV application	N3172	S55770-T106	RDU341
Touch screen room thermostat with KNX communications, for heating application (for China frames)	N3175	S55770-T336	RDD810KN/NF
VAV compact controller KNX, 24 V, 5 Nm, 150 s, 300 Pa	N3547	S55499-D134	GDB181.1E/KN
VAV compact controller KNX, 24 V, 10 Nm, 150 s, 300 Pa	N3547	S55499-D135	GLB181.1E/KN
Base module with KNX for temperature and humidity measurement	N1411	BPZ:AQR2570..	AQR2570..
Base modules with KNX for CO ₂ measurement	N1411	BPZ:AQR2576..	AQR2576..
Front modules for base modules	N1410	BPZ:AQR253..	AQR253..
Room sensor KNX for temperature	N1602	S55624-H103	QMX3.P30
Room sensor KNX for temperature, humidity, CO ₂	N1602	S55624-H104	QMX3.P70

Standard controllers
Software and central communication units
For web and remote operation via KNX: OZW77..

Web server for Synco devices

OZW772..

Web server OZW772 allows for remote plant control and monitoring via the web.



- Operate web browser via PC/laptop and Smartphone
- Operate ACS (PC/laptop with ACS plant operating software)
- Connections: USB and Ethernet
- Display fault messages in the web browser
- Send fault messages to a maximum of 4 e-mail recipients
- Periodically send system reports to e-mail recipients
- Visualize the plants in the web browser based on standard plant diagrams and customized plant web pages
- Acquire and display consumption data
- Send consumption data file to 2 email recipients
- Function "Energy indicator" to monitor data points for energy-related limit values, or "Green limits"
- Web services for external applications via Web API (Web Application Programming Interface)
- Encrypted with https and TLS for e-mails
- Record of trends, display and dispatch to 2 e-mail recipients
- Integration up to 237 S-Mode data points of KNX devices (not OZW772.01)
- Direct commissioning with web browser or ACS service tool

Data sheet	N5701
Operating voltage	Power pack: AC 230 V Web server: DC 24 V
Communication	KNX TP1 (wire-Bus) Ethernet, RJ45 plug socket (shielded) USB V2.0 (universal serial bus)
Mounting	On DIN rails With Screws
Dimensions (W x H x D)	87.5 x 90 x 40 mm

Range overview OZW772..

Product Title	Stock No.	Product No.
Web server for 1 Synco device	BPZ:OZW772.01	OZW772.01
Web server for 4 Synco devices	BPZ:OZW772.04	OZW772.04
Web server for 16 Synco devices	BPZ:OZW772.16	OZW772.16
Web server for 250 Synco devices	BPZ:OZW772.250	OZW772.250

Standard controllers

Software and central communication units

For web and remote operation via KNX: OZW77..

OZW771..



Central communication unit OZW771..

The OZW771... central communication unit is a component of the Synco™ system. It is used for the remote operation and supervision of plants with Synco™ 700 Synco™ RXB... and Synco™ living units in KNX network systems.

Alarm messages can be delivered to

- ACS operating station (ACS alarm)
- SMS receivers
- Fax machines*
- Pagers
- E-mail receivers*

* Only possible with GSM modem, depending also on the telephone provider

Data sheet	N3117
Operating voltage	AC 230 V
Frequency	50/60 Hz
Power consumption	5 VA
Digital inputs, number	2
Dimensions (W x H x D)	161 x 110 x 62 mm

Range overview OZW771..

Product Title	Data sheet	Stock No.	Product No.
Central communication unit, max. 4 controllers	N3117	BPZ:OZW771.04	OZW771.04
Central communication unit, max. 10 controllers	N3117	BPZ:OZW771.10	OZW771.10
Central communication unit, max. 64 controllers	N3117	BPZ:OZW771.64	OZW771.64

Accessory for OZW771..

Product Title	Stock No.	Product No.
Terminal covers	BPZ:7411100280	7411100280

Refer to the central unit data sheet for details

Standard controllers
Software and central communication units
Operating, service and alarm software for HVAC plants: ACS790

Commissioning and plant operating software

ACS790

PC software for commissioning, operating and supervision of HVAC plants.
 Consists of 2 programs: ACS-Tool and ACS-Alarm.

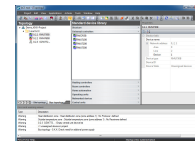

ACS-Tool:

for plant commissioning, operating and service

- Popcard (standard and customized)
- Plant diagram (standard and customized)
- Plant view (standard and customized)
- Trend functions (online and offline)
- File transfer
- Parameter settings
- Commissioning protocol

ACS-Alarm:

- For receiving and managing alarms

Commissioning and service via OCI700 service interface

Compatible devices see OCI700.1.

Plant operation and supervision for

KNX systems

- Central units: OZW771, OZW772
- Synco™ living: QAX9...
- Controllers: Synco™700, Synco RXB/RXL
- Thermostats: RDF..., RDG..., RDU341
- Sensors: QMX3.P30, QMX3.P70, AQR253.. and AQR257..

LPB systems

- Central units: OCI611, OZW672
- Controllers: RVD2..., RVL4..., RVP3..

Data sheet

N5649

	Stock No.	Product No.
	S55800-Y100	ACS790

OCI700.1



Service tool for KNX / LPB

The service tool consists of:

- ACS790 CD-ROM
- OCI700 service interface
- USB cable
- Service cable for Synco™ controllers
- Service cable for SIGMAGYR® and ALBATROS controllers

Commissioning and diagnostics of the following devices:

Synco devices:

- Central communication units OZW771, OZW772
- Heating controllers RMH of the 700-series
- Boiler sequence controllers RMK of the 700-series
- Universal controllers RMU of the 700-series
- Universal controllers RLU of the 200-series
- Switching and monitoring devices RMS of the 700-series
- Room unit QAW740
- Central control units RMB of the 700-series
- Individual room controllers RXB.. / RXL..
- Signal converter SEZ220
- Synco™ living central apartment unit QAX9..
- Synco™ thermostats RDF.., RDG.., RDU341
- Sensores: QMX3.P30, QMX3.P70, AQR253.. and AQR257..

LPB devices:

- Central communication units OCI611 and OZW672
- Heating controllers RVL of the 4..-series
- Heating controllers RVP of the 3..-series
- District heating controllers RVD of the 2..-series

Data sheet

N5655

Stock No.

Product No.

BPZ:OCI700.1

OCI700.1

OCI702



Service interface for USB / KNX

The service interface consists of:

- OCI702 service interface
- USB 2.0 cable (Type A / B)
- KNX service cable for Synco™ controllers (RJ45 / RJ45)
- KNX service cable for Desigo™ TRA (RJ45 / jack plug 2.5 mm)
- KNX service cable (RJ45 / KNX bus terminal)

With the respective PC software, the interfaces allows to commission and service devices with KNX communication, e.g. from the following ranges:

- Synco™ 700 controllers and room devices
- KNX room thermostats RDF..., RDG..., RDU341
- Individual room controllers RXB... / RXL...
- Synco™ living central apartment units QAX9...
- Desigo TRA
- GAMMA devices

Data sheet

A6V10438951

Stock No.

Product No.

S55800-Y101

OCI702

Room automation Synco

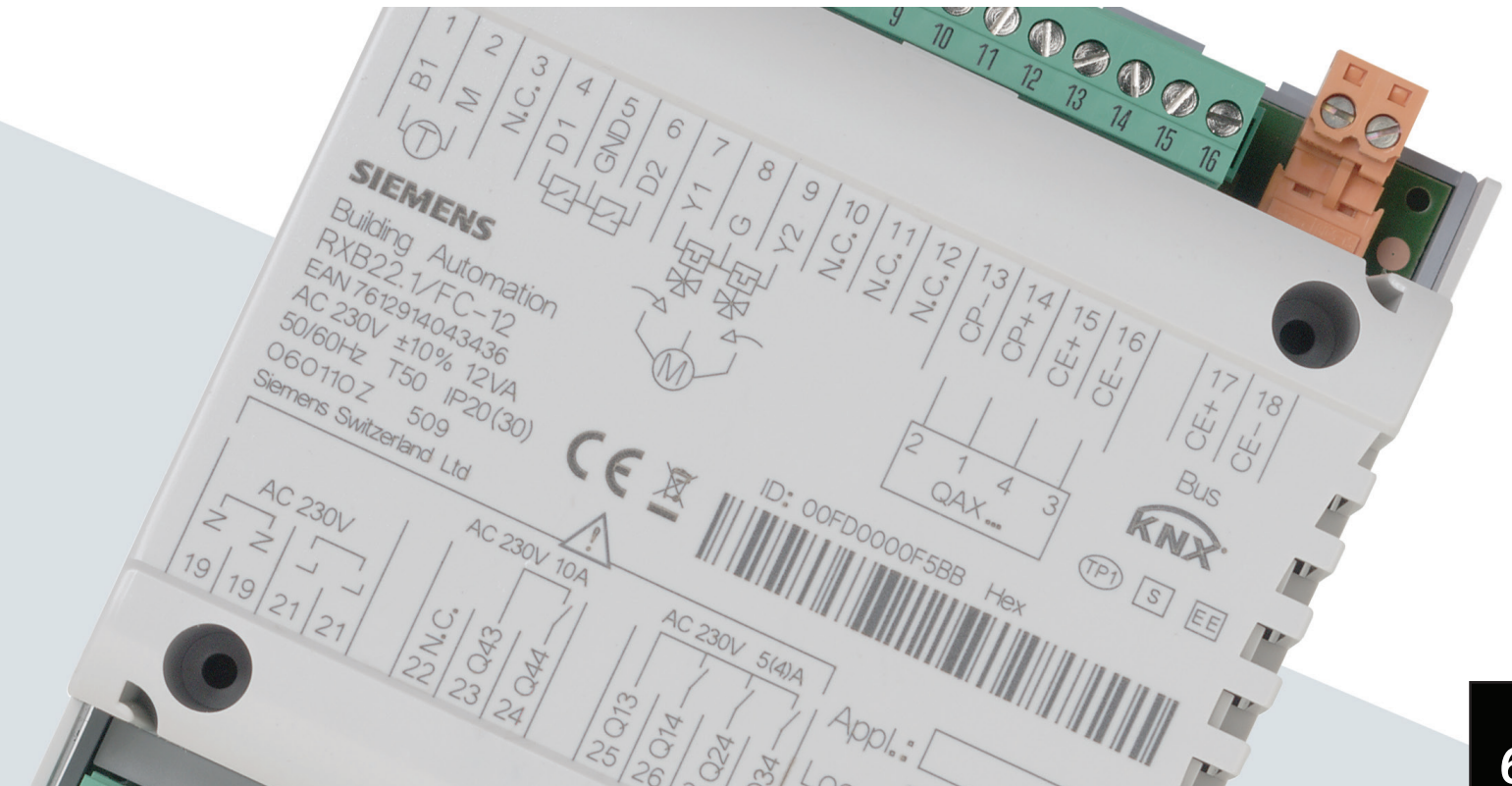



Overview and selection tool	Product range overview	6-2
	RXL Application	6-5
	RXB Application	6-7
Communicating controllers - RXL (Bus)	For fan coil, radiator, chilled ceiling	6-9
	Field devices	6-11
Communicating controllers - RXB (KNX)	For fan coil, radiator, chilled ceiling	6-13
	Field devices	6-15
Communicating room thermostats	For fan coil units - Communicating KNX thermostat RDG.. / RDF..	6-17
	For VAV systems - Communicating KNX thermostat RDG.. / RDU..	6-22
Central control unit RMB..	For room controller and room thermostats RXB.. / RXL.. / RDG.. / RDF.. / RDU..	6-25
	Extension modules and operator units for RMB..	6-27
Room operator units	For controllers RX.. (PPS2): QAX3.. / QAX8..	6-28
	For controllers RM.. (KNX) QAW74..	6-31
	Room operator units QMX3.. (KNX)	6-32
	For controllers RX.. (EnOcean): QAX9.. / RXZ9..	6-34
Damper actuator (KNX)	VAV compact controller with KNX	6-37
KNX accessories	Transformers	6-38
	KNX - System components	6-39
	KNX - Line Couplers	6-41
	KNX - Power Supply Units	6-42

Room automation Synco

Overview and selection tools

Product range overview

Thermostats

Type									
	RDG100KN	RDG160KN	RDG400KN	RDF800KN	RDF600KN	RDF301	RDF301.50	RDF301.50H	RDU341
Design									
Wall mounted	■	■	■	■	■	■	■	■	■
Semi-Flush Mounted				■	■	■	■	■	■
for VDE/CEE box				★	★				
for British Standard box				■	■	★	■	■	■
Housing									
Digital display	■	■	■	■	■	■	■	■	■
Touch Screen Display				★					
Setpoint knob	■	■	■						
Operating mode button	■	■	■		■	■	■	■	■
Fan speed button	■	■			■	■	■	■	
Buttons for light and blind control							★		
Button for Hotel application								★	
Bus connection									
Integrated bus coupling units	■	■	■	■	■	■	■	■	■
Power supply									
Terminal voltage AC 230 V	■			■	■	■	■	■	
Terminal voltage AC 24 V		■	■						■
Integrated room temperature	■	■	■	■	■	■	■	■	■
Inputs									
Multifunctional inputs digital/analog	3	3	3	2	2	2	2	2	2
Outputs									
ON/OFF (PWM) Triac (H/C)	■		■						
ON/OFF Relay (H/C)		■		■	★	★	■	■	■
Analog outputs DC 0..10V (H/C)		★	■						■
3-stage Relay (fan)	■	■		■	■	■	■	■	
Analog DC 0..10 V (fan)		★							
Applications									
Fancoil 2-/4-pipe	■	■		■	■	■	■	■	
Fancoil with electrical heater	■	■		■	■	■	■	■	
Fancoil with Radiator	■	■							
Heating / Cooling 2-/4-pipe	■	■		■					
Heat Pump System		■		■	■	■	■		
Variable Air Volume (VAV)			■						■
VAV with electrical heater			■						■
VAV with radiator / Heat-Cool coil			■						
Functionalities									
2-position control	■	■	■	■	■	■	■	■	■
Modulating control	■	■	■	■ ²⁾	■ ²⁾	■ ²⁾	■ ²⁾	■ ²⁾	■
2-stage control sequence for heating or cooling	■	■		■ ¹⁾	■ ¹⁾	■ ¹⁾	■ ¹⁾	■ ¹⁾	
Operating mode									
Comfort	■	■	■	■	■	■	■	■	■
Pre-Comfort									
Economy	■	■	■	■	■	■	■	■	■
Protection	■	■	■	■	■	■	■	■	■
Manual / Auto operating mode	■	■	■	■	■	■	■	■	■

¹⁾ only for 2-stage heating

²⁾ modulating output only for 2-pipe applications

■ valid for all variants ★ main feature

Room operation



	QAX..								QAW..
Features	30.1	31.1	32.1	33.1	34.1	34.3	39.1	84.1	740
Display					■	■		■	■
Mode selection			■	■	■	■		■	■
Fan switch				■	■	■		■	
Setpoint adjuster		■	■	■	■	■	■	■	■
Temperature sensor	■	■	■	■	■	■		■	
Mounting									
Flush-mounted							■	■	
Directly on wall	■	■	■	■	■	■			■
Control panel(door)							■		
Communication									
PPS2	■	■	■	■	■	■	■	■	
KNX									■
Controller									
RXL..	■	■	■	■	■	■	■	■	
RXB..	■	■	■	■	■	■	■	■	
Synco700									■

6

Room units KNX



	P30	P70	QMX3..		
Features			P34	P74	P37
Display		■ ¹⁾	■	■	■
Mode selection			■	■	■
Fan switch			■	■	■
Setpoint adjuster			■	■	■
Temperature sensor	■	■	■	■	■
Humidity sensor		■		■	
Air quality sensor		■		■	
Mounting					
Flush-mounted					
Directly on wall	■	■	■	■	■
Communication					
EnOcean					
KNX	■	■	■	■	■
Controller					
RXL..					
RXB..	■	■	■	■	■

¹⁾ LED for air quality indicator
²⁾ Suitable receivers: RXZ97.1/KNX

Wireless room operation



	95.4	96.4	97.4	98.4
Display				
Mode selection			■	■
Fan switch				■
Setpoint adjuster		■	■	■
Temperature sensor	■	■	■	■
Mounting				
Flush-mounted	■	■	■	■
Directly on wall	■	■	■	■
Communication				
EnOcean	■	■	■	■
KNX	■ ²⁾	■ ²⁾	■ ²⁾	■ ²⁾
Controller				
RXL..				
RXB..	■	■	■	■

Room automation Synco

Overview and selection tools

Product range overview

RXL applications

RXL – Powerful room controllers for temperature control in individual rooms

RXL ensures individual demand-based comfort in public buildings, offices, schools, hotels, etc. Flexible control of all types of equipment in individual rooms calls for economical and convenient solutions that can be integrated into existing or new systems and will retain their compatibility long into the future.

Communicating controllers for individual rooms

The communicating room controllers RXL21.1, RXL22.1 and RXL24.1 are used for temperature control in individual rooms. RXL39.1 support energy efficient EC fan-coils. Siemens actuator and sensor technology can be connected.

Easy commissioning with room operator unit

Commissioning and parameter-setting for RXL controllers is carried out directly on the controller, with the QAX34.3 room operator unit. There is no need for a network connection or a software tool. Mounting on a DIN rail is quick and simple.

User-friendly commissioning and service

The Service LED shows the operational status of the room controller at all times. For example, a flashing green LED is used to indicate normal, trouble-free operation, a continuous red LED for addressing mode and a flashing red LED to indicate a fault. With the service pin, all controllers can be easily identified for commissioning or maintenance purposes. As soon as the service pin is pressed, the red service LED on the controller lights up and the controller is displayed on a graphic of the building at the management platform.

Complete range of standard room operating units



The extensive range of room operator units is available for direct operation and monitoring of setpoints and measured values in individual rooms. The range extends from very simple room temperature sensors to versatile room operator units with parameter-setting functions.

Integration into Synco™

The Synco™ central control unit RMB795 is used for controlling and monitoring the RXL controllers in a Synco™ system.

6

HVAC

Chilled ceiling Radiator-type systems			
Fan coil units			
	QAX30 QAX31 QAX32 QAX33 QAX34 QAX39 QAX84 QAX90 QAX91 AQR2531..	RXL21.1 RXL22.1 RXL24.1 RXL39.1	



Fields of application

The scope of RXL is defined by the preprogrammed application software. The following pages provide an overview of the options and the corresponding devices. The devices are supplied preprogrammed with the applications. The required application can be selected by means of the Handy tool QAX34.3.

Due to the fact that the applications are predefined, engineering simply involves the definition of a small number of parameters, e. g.:

- PWM or 3-point control of the valves and actuators (RXL39.1: 0-10V DC control of motoric actuator)
- Temperature setpoints
- Manual or automatic fan control

Fan coil systems

Application	Description	Devices
FNC02	2-pipe system with changeover	RXL21.1/FC-10
FNC03	2-pipe system with changeover and electrical reheater	RXL22.1/FC-12
FNC04	4-pipe system	RXL21.1/FC-10
FNC05	4-pipe system with electrical reheater	RXL22.1/FC-12
FNC08	4-pipe system with supply air temperature limitation	RXL21.1/FC-10
FNC10	2-pipe system with change over and outside air damper	RXL21.1/FC-11
FNC12	4-pipe system with outside damper	RXL21.1/FC-11
FNC18	2-pipe system with change over and radiator	RXL21.1/FC-11
FNC20	4-pipe system with air-side control	RXL21.1/FC-10
FNC02/03/04/08	2-pipe/4-pipe system with EC fan-coil support	RXL39.1/FC-13

Common functions

- Window contact, occupancy detector, 4 operating modes
- Manual fan control with room unit
- Automatic fan control (RXL21.1/RXL22.1 three speed; RXL39.1 continuous speed 0..10V)
- Options for 2-pipe systems: heating only, cooling only or changeover

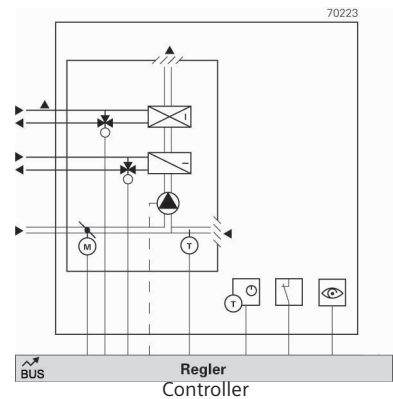

Heated/chilled ceilings and radiators

Application	Description	Devices
CLC01	Chilled ceiling with dewpoint monitoring	RXL24.1/CC-02
CLC02	Chilled ceiling with dewpoint monitoring, radiator with downdraft compensation	RXL24.1/CC-02
RAD01	Radiator with downdraft compensation	RXL24.1/CC-02

Common functions

- Window contact, occupancy detector, 4 operating modes

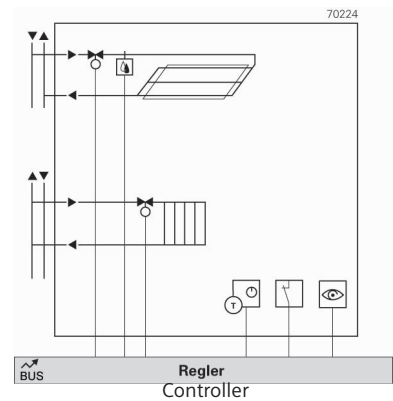

Room automation Synco

Overview and selection tools

Product range overview

RXB applications

RXB hardware

The product range comprises compact controllers and corresponding room units for comfortable control. The compact room controllers are optimized to the respective application with regard to input/output configuration. HVAC functions are operated via standard room units. Communication is based on KNX S-mode. The fan coil room controllers communicate also in KNX LTE mode. KNX LTE mode is used to communicate with control equipment from the Synco™ 700 product range.

RXB software

Each RXB unit comes with preloaded application software featuring one or several applications (see next page). The ETS software helps engineer and commission a network with RXB units. In addition, the Synco™ tool and room unit QAX34.3 by Siemens can be used for commissioning and parameterization. To use QMX3 room operating units or sensors ETS-software must be used in every case.

Integration into Synco™

The Synco™ central control unit RMB795 is used for controlling and monitoring the RXB controllers in a Synco™ system.

Connection to the Desigo building automation and control system

Desigo PX KNX allow for flexibly connecting RXB controllers to the Desigo building automation and control system, and hence acts as a gateway to BACnet. The connection provides access to other functions such as time schedules and central control of setpoints. RXB thus fits into the overall expandable modular system, and ensures long-term cost-efficiency.

6

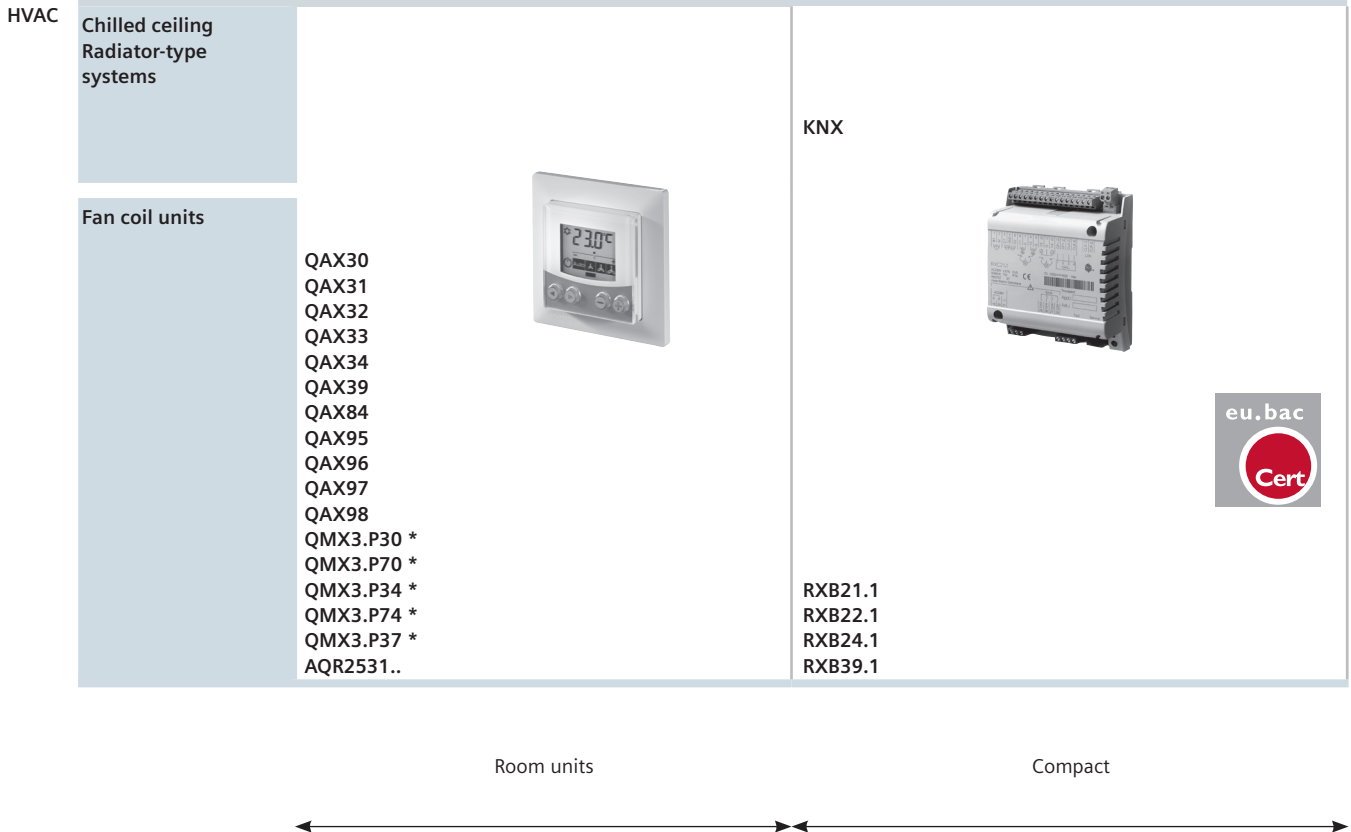

* ETS-software must be used

Fields of application

The scope of RXB is defined by the preprogrammed application software. The following pages provide an overview of the options and the corresponding devices, divided into different areas of application. The devices are supplied preprogrammed with the applications. The required application can be selected by means of the ETS, Synco™ tool or the Handy tool QAX34.3.

Due to the fact that the applications are predefined, engineering simply involves the definition of a small number of parameters, e. g.:

- PWM or 3-point control of the valves and actuators (RXL39.1: 0-10V DC control of motoric actuator)
- Temperature setpoints
- Manual or automatic fan control

Fan coil systems

Application	Description	Devices
FNC02	2-pipe system with changeover	RXB21.1/FC-10
FNC03	2-pipe system with changeover and electrical reheater	RXB22.1/FC-12
FNC04	4-pipe system	RXB21.1/FC-10
FNC05	4-pipe system with electrical reheater	RXB22.1/FC-12
FNC08	4-pipe system with supply air temperature limitation	RXB21.1/FC-10
FNC10	2-pipe system with changeover and outside air damper	RXB21.1/FC-11
FNC12	4-pipe system with outside damper	RXB21.1/FC-11
FNC18	2-pipe system with change over and radiator	RXB21.1/FC-11
FNC20	4-pipe system with air-side control	RXB21.1/FC-10
FNC02/03/04/08	2-pipe/4-pipe system with EC fan-coil support	RXB39.1/FC13

Common functions

- Window contact, occupancy detector, 4 operating modes
- Manual fan control with room unit
- Automatic fan control (RXB21.1/RXB22.1 three speed; RXB39.1 continuous speed 0..10V)
- Options for 2-pipe systems: heating only, cooling only or change-over, via KNX bus

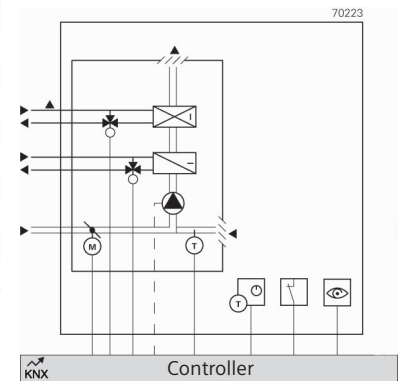

Heated/chilled ceilings and radiators

Application	Description	Devices
CLC01	Chilled ceiling with dewpoint monitoring	RXB24.1/CC-02
CLC02	Chilled ceiling with dewpoint monitoring and radiator	RXB24.1/CC-02
RAD01	Radiator with downdraft compensation	RXB24.1/CC-02

Common functions

- Window contact, occupancy detector, 4 operating modes

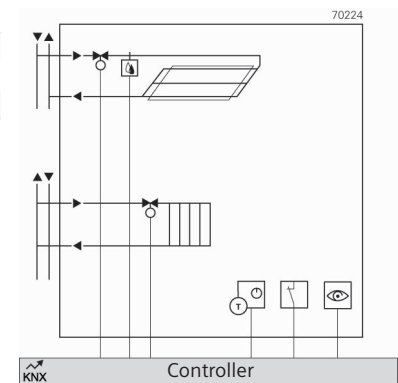

RXL2..

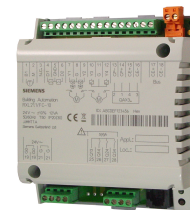

Room controller with bus communication

The controllers RXL2.. are used for temperature control in individual rooms.

- For 2-pipe with changeover or 4-pipe fan coil systems
- Control of thermic valve actuators AC 24 V, PDM, valve and damper actuators AC 24 V (3-position)
- Volt-free relay contacts for fan speed control
- Relay for electric heating (RXL22.1 only)
- Bus communication
- Connection to Desigo building automation and control system via PX KNX
- Commissioning with "Handy Tool" QAX34.3 or Synco ACS

Application description fan coil: CM110677

Application description RAD/CLC: CM110676

Operating voltage	AC 24 V
Frequency	50/60 Hz
Power consumption	15 VA
Control algorithm	PI
Digital inputs, number	2
Triac outputs	ON/OFF PWM 3-position
Triac output, switching voltage	AC 24 V
Triac output, switching current	0.5 A
Relay output, switching voltage	AC 250 V
Relay output, switching current	5 (4) A
Communication	Bus Room unit: PPS2
Service plug	RXT20.1
Mounting location	Ceiling voids with cover Fan coil Panel
Mounting	On DIN rail With screws
Dimensions (W x H x D)	113 x 167 x 62 mm



Range overview RXL2..

Product Title	Triac outputs, number	Relay outputs, number	Data sheet	Stock No.	Product No.
Room controller for 3-speed fan	4	3	N3877	BPZ:RXL21.1/FC-10	RXL21.1/FC-10
Room controller for 3-speed fan	4	3	N3877	BPZ:RXL21.1/FC-11	RXL21.1/FC-11
Room controller with 3-speed fan and electric heating coil	2	4	N3877	BPZ:RXL22.1/FC-12	RXL22.1/FC-12
Room controller for chilled ceilings and radiators	4	0	N3878	BPZ:RXL24.1/CC-02	RXL24.1/CC-02

The application determines the usable actuator (PWM /3-position) with the triac output

Room automation Synco

Communicating controllers - RXL (Bus)

For fan coil, radiator, chilled ceiling

RXL39.1/FC-13



Communicating room controller for fan-coil applications with proprietary communication

The RXL39.1 room controller is used for temperature control in individual rooms.

- For 2-pipe and 4-pipe fan coil systems with or without changeover
- PI control
- Proprietary bus communication
- Connection to Desigo building automation and control system via PX KNX
- DC 0...10 V control of valve and actuators, fan (ECM), and electric heater
- Potential-free relay contacts to release fan and electric heating
- Commissioning with "Handy Tool" QAX34.3 or Synco ACS

Data sheet	N3876
Operating voltage	AC 230 V
Frequency	50/60 Hz
Power consumption	12 VA
Control algorithm	PI
Digital inputs, number	4
Digital outputs, number	0
Analog inputs, number	2
Analog outputs, number	3
Relay output, switching voltage	AC 250 V
Relay output, switching current	5 (4) A
Communication	Bus: proprietary Room unit: PPS2
Service plug	ACS, HandyTool
Mounting	On DIN rail
Degree of protection	IP20
Dimensions (W x H x D)	152 x 120 x 62 mm

Stock No. Product No.

S55373-C122 **RXL39.1/FC-13**

Accessories for RXL..

Product Title	Data sheet	Stock No.	Product No.
Power amplifier for thermal actuators AC 24 V, PWM	N3591	BPZ:UA1T	UA1T
Terminal cover for RXB../RXL2../RXC2../RXM2..	N3834	BPZ:RXZ20.1	RXZ20.1
Terminal cover for RXB3../RXL3../RXC3../RXM3..	N3840	BPZ:RXZ30.1	RXZ30.1
Power supply unit DC 29 V, 160 mA with additional unchoked output, N 125/02	2.14.4.4	5WG1125-1AB02	N 125/02
Power supply unit DC 29 V, 320 mA with additional unchoked output, N 125/12	2.14.4.4	5WG1125-1AB12	N 125/12
Power supply unit DC 29 V, 640 mA with additional unchoked output, N 125/22	2.14.4.4	5WG1125-1AB22	N 125/22

Room units for RXL..

Product Title	Data sheet	Stock No.	Product No.
Room unit with sensor and PPS2 interface	N1741	BPZ:QAX30.1	QAX30.1
Room unit with sensor, setpoint adjuster and PPS2 interface	N1741	BPZ:QAX31.1	QAX31.1
Room unit with sensor, setpoint and operating mode selector and PPS2 interface	N1641	BPZ:QAX32.1	QAX32.1
Room unit with sensor, setpoint and operating mode selector, fan speed selection, and PPS2 interface	N1642	BPZ:QAX33.1	QAX33.1
Room unit with sensor, setpoint and operating mode selector, display and PPS2 interface	N1645	BPZ:QAX34.1	QAX34.1
Room unit with sensor, setpoint and operating mode selector, display and PPS2 interface	N1640	BPZ:QAX34.3	QAX34.3
Flush-mounted room unit complete with PPS2 interface and design frame	N1649	BPZ:QAX84.1/PPS2	QAX84.1/PPS2
Universal setpoint adjuster with PPS2 interface	N1646	BPZ:QAX39.1	QAX39.1

Temperature sensors for RXL..

Product Title	Data sheet	Stock No.	Product No.
Room temperature sensor LG-Ni1000	N1721	BPZ:QAA24	QAA24
Front module with passiv temperature measurement, LG-Ni1000	N1408	S55720-S133	AQR2531ANW
Room temperature sensor LG-Ni1000 for mounting on recessed conduit boxes	N1722	BPZ:QAA64	QAA64
Cable temperature sensor PVC 2 m, LG-Ni1000	N1831	BPZ:QAP22	QAP22
Duct temperature sensor 400 mm, LG-Ni1000	N1761	BPZ:QAM2120.040	QAM2120.040

For the complete flush mounting sensor offering including mounting plates and frames, see chapter 6

Dewpoint sensor for RXL..

Product Title	Data sheet	Stock No.	Product No.
Condensation monitor, AC/DC 24 V	N3302	S55770-T325	QXA2601
Condensation monitor, AC/DC 24 V, with remote sensor head (cable length 1.5 m)	N3302	S55770-T326	QXA2602
Condensation monitor, AC 230 V	N3302	S55770-T327	QXA2603
Condensation monitor, AC 230 V, with remote sensor head (cable length 1.5 m)	N3302	S55770-T328	QXA2604

Valve actuators for RXL..

Product Title	Data sheet	Stock No.	Product No.
Electrothermal actuator, AC/DC 24 V, NC, 2P, PDM, PR	N4884	S55174-A115	STA73PR/00
Electrothermal actuator, AC/DC 24 V, NO, 2P, PDM, PR	N4884	S55174-A116	STP73PR/00
Electromotoric actuator, 100 N, 2.5/5 mm, 1.5 m, AC 24 V, 3P	N4893	BPZ:SSA81	SSA81
Electromotoric actuator, 200 N, 5.5 mm, AC 24 V, 1.5 m, 3P	N4891	BPZ:SSB81	SSB81
Electromotoric actuator, 160 N, 2.5 mm, 1.5 m, AC 24 V, 3P	N4864	BPZ:SSP81	SSP81

Room automation Synco

Communicating controllers - RXL (Bus)

Field devices

Damper actuators for RXL..

Product Title	Data sheet	Stock No.	Product No.
Rotary air damper actuators 5 Nm, without spring return	N4634	BPZ:GDB..1E	GDB..1E
Linear air damper actuators 125 N, without spring return	N4664	BPZ:GDB..2E	GDB..2E
Rotary air damper actuators 10 Nm, without spring return	N4634	BPZ:GLB..1E	GLB..1E
Linear air damper actuators 250 N, without spring return	N4664	BPZ:GLB..2E	GLB..2E

Interfaces and tools RXB..

Product Title	Data sheet	Stock No.	Product No.
Service unit with LCD	N3851	BPZ:RXT20.1	RXT20.1
Room unit with sensor, setpoint and operating mode selector, display and PPS2 interface	N1640	BPZ:QAX34.3	QAX34.3

RXB2..



Room controller with KNX communication

The controllers are used for temperature control in individual rooms.

- For 2-pipe with changeover or 4-pipe fan coil systems
- For radiator and chilled ceiling (RXB24.1 only)
- Control of thermal valve actuators AC 24 V, PDM, valve and damper actuators AC 24 V (3-position) as well as KNX bus actuators
- Potential-free relay contacts for fan speed control
- Connecting relay for electric heating (RXB22.1 und RXB39.1)
- KNX bus communication
- Connection to Desigo building automation and control system via PX KNX
- Commissioning with "Handy Tool" QAX34.3 or Synco ACS

Application description fan coil: CM110672

Application description RAD/CLC: CM110671

Operating voltage	AC 230 V
Frequency	50/60 Hz
Power consumption	Max. 12 VA
Control algorithm	PI
Digital inputs, number	2
Triac outputs	ON/OFF PWM 3-position
Triac output, switching voltage	AC 24 V
Triac output, switching current	0.5 A
Relay output, switching voltage	AC 250 V
Relay output, switching current	5 (4) A
Communication	Bus: KNX (S-mode and LTE mode) Room unit: PPS2
Service plug	RXT20.1
Mounting location	Ceiling voids with cover Fan coil Panel
Mounting	On DIN rail With screws
Dimensions (W x H x D)	113 x 167 x 62 mm



Range overview RXB2..

Product Title	Triac outputs, number	Relay outputs, number	Data sheet	Stock No.	Product No.
Room controller for 3-speed fan	4	3	N3873	BPZ:RXB21.1/FC-10	RXB21.1/FC-10
Room controller for 3-speed fan	4	3	N3873	BPZ:RXB21.1/FC-11	RXB21.1/FC-11
Room controller with 3-speed fan and electric heating coil	2	4	N3873	BPZ:RXB22.1/FC-12	RXB22.1/FC-12
Room controller for chilled ceilings and radiators	4	0	N3874	BPZ:RXB24.1/CC-02	RXB24.1/CC-02

The application determines the usable actuator (PWM /3-position) with the triac output

Room automation Synco

Communicating controllers - RXB (KNX)

For fan coil, radiator, chilled ceiling

RXB39.1/FC-13



Room controller for fan-coil applications with KNX communication

The RXB39.1 room controller is used for temperature control in individual rooms.

- For 2-pipe and 4-pipe fan coil systems with or without changeover
- PI control
- KNX bus communication
- Connection to Desigo building automation and control system via PX KNX
- DC 0...10 V control of valve and actuators, fan (ECM), and electric heater
- 2 Potential-free relay contacts to release fan and electric heating
- Commissioning with ETS Professional, "Handy Tool" QAX34.3 or Synco ACS
- Operating voltage AC 230 V
- Plug-in screw terminals

Data sheet	N3875
Operating voltage	AC 230 V
Frequency	50/60 Hz
Power consumption	12 VA
Control algorithm	PI
Digital inputs, number	4
Digital outputs, number	0
Analog inputs, number	2
Analog outputs, number	3
Relay output, switching voltage	AC 250 V
Relay output, switching current	5 (4) A
Degree of protection	IP20
Communication	Bus: KNX Room unit: PPS2
Service plug	ETS Professional, ACS, HandyTool
Mounting	On DIN rail
Dimensions (W x H x D)	152 x 120 x 62 mm

Stock No. Product No.

S55373-C121 **RXB39.1/FC-13**

Accessories for RXB..

Product Title	Data sheet	Stock No.	Product No.
Power amplifier for thermal actuators AC 24 V, PWM	N3591	BPZ:UA1T	UA1T
Terminal cover for RXB../RXL../RXC2../RXM2..	N3834	BPZ:RXZ20.1	RXZ20.1
Terminal cover for RXB3../RXL3../RXC3../RXM3..	N3840	BPZ:RXZ30.1	RXZ30.1
Power supply unit DC 29 V, 160 mA with additional unchoked output, N 125/02	2.14.4.4	5WG1125-1AB02	N 125/02
Power supply unit DC 29 V, 320 mA with additional unchoked output, N 125/12	2.14.4.4	5WG1125-1AB12	N 125/12
Power supply unit DC 29 V, 640 mA with additional unchoked output, N 125/22	2.14.4.4	5WG1125-1AB22	N 125/22

Room units for RXB..

Product Title	Data sheet	Stock No.	Product No.
Room unit with sensor and PPS2 interface	N1741	BPZ:QAX30.1	QAX30.1
Room unit with sensor, setpoint adjuster and PPS2 interface	N1741	BPZ:QAX31.1	QAX31.1
Room unit with sensor, setpoint and operating mode selector and PPS2 interface	N1641	BPZ:QAX32.1	QAX32.1
Room unit with sensor, setpoint and operating mode selector, fan speed selection, and PPS2 interface	N1642	BPZ:QAX33.1	QAX33.1
Room unit with sensor, setpoint and operating mode selector, display and PPS2 interface	N1645	BPZ:QAX34.1	QAX34.1
Room unit with sensor, setpoint and operating mode selector, display and PPS2 interface	N1640	BPZ:QAX34.3	QAX34.3
Flush-mounted room unit complete with PPS2 interface and design frame	N1649	BPZ:QAX84.1/PPS2	QAX84.1/PPS2
Room unit with EnOcean interface	N1663	S55623-H104	QAX95.4
Room unit with EnOcean interface, setpoint adjuster	N1663	S55623-H105	QAX96.4
Room unit with EnOcean interface, setpoint adjuster, button and switch	N1663	S55623-H106	QAX97.4
Room unit with EnOcean interface, setpoint adjuster, button and switch for fan stages	N1663	S55623-H107	QAX98.4
Radio frequency receiver with Gateway EnOcean/KNX	N1662	S55842-Z101	RXZ97.1/KNX
Universal setpoint adjuster with PPS2 interface	N1646	BPZ:QAX39.1	QAX39.1
Room operator unit KNX with temperature sensor, segmented backlit display, touchkeys	N1602	S55624-H105	QMX3.P34
Room operator unit KNX with sensors for temperature, humidity, CO2, segmented backlit display, touchkeys	N1602	S55624-H106	QMX3.P74
Room operator unit KNX with temperature sensor, segmented backlit display, configurable touchkeys, LED display	N1602	S55624-H108	QMX3.P37

Temperature sensors for RXB..

Product Title	Data sheet	Stock No.	Product No.
Room temperature sensor LG-Ni1000	N1721	BPZ:QAA24	QAA24
Front module with passiv temperature measurement, LG-Ni1000	N1408	S55720-S133	AQR2531ANW
Room temperature sensor LG-Ni1000 for mounting on recessed conduit boxes	N1722	BPZ:QAA64	QAA64
Cable temperature sensor PVC 2 m, LG-Ni1000	N1831	BPZ:QAP22	QAP22
Duct temperature sensor 400 mm, LG-Ni1000	N1761	BPZ:QAM2120.040	QAM2120.040
Room sensor KNX for temperature	N1602	S55624-H103	QMX3.P30
Room sensor KNX for temperature, humidity, CO2	N1602	S55624-H104	QMX3.P70

For the complete flush mounting sensor offering including mounting plates and frames, see chapter 6

Room automation Synco

Communicating controllers - RXB (KNX)

Field devices

Dewpoint sensors for RXB..

Product Title	Data sheet	Stock No.	Product No.
Condensation monitor, AC/DC 24 V	N3302	S55770-T325	QXA2601
Condensation monitor, AC/DC 24 V, with remote sensor head (cable length 1.5 m)	N3302	S55770-T326	QXA2602
Condensation monitor, AC 230 V	N3302	S55770-T327	QXA2603
Condensation monitor, AC 230 V, with remote sensor head (cable length 1.5 m)	N3302	S55770-T328	QXA2604

Valve actuators for RXB..

Product Title	Data sheet	Stock No.	Product No.
Electrothermal actuator, AC/DC 24 V, NC, 2P, PDM, PR	N4884	S55174-A115	STA73PR/00
Electrothermal actuator, AC/DC 24 V, NO, 2P, PDM, PR	N4884	S55174-A116	STP73PR/00
Electromotoric actuator, 100 N, 2.5/5 mm, 1.5 m, AC 24 V, 3P	N4893	BPZ:SSA81	SSA81
Electromotoric actuator, 200 N, 5.5 mm, AC 24 V, 1.5 m, 3P	N4891	BPZ:SSB81	SSB81
Electromotoric actuator, 160 N, 2.5 mm, 1.5 m, AC 24 V, 3P	N4864	BPZ:SSP81	SSP81

Damper actuators for RXB..

Product Title	Data sheet	Stock No.	Product No.
Rotary air damper actuators 5 Nm, without spring return	N4634	BPZ:GDB..1E	GDB..1E
Linear air damper actuators 125 N, without spring return	N4664	BPZ:GDB..2E	GDB..2E
Rotary air damper actuators 10 Nm, without spring return	N4634	BPZ:GLB..1E	GLB..1E
Linear air damper actuators 250 N, without spring return	N4664	BPZ:GLB..2E	GLB..2E

Interfaces and tools RXB..

Product Title	Data sheet	Stock No.	Product No.
Service unit with LCD	N3851	BPZ:RXT20.1	RXT20.1
Room unit with sensor, setpoint and operating mode selector, display and PPS2 interface	N1640	BPZ:QAX34.3	QAX34.3

Room automation Synco
Communicating room thermostats
For fan coil units - Communicating KNX thermostat RDG.. / RDF..

RDG100KN



Room thermostat with KNX communications, AC 230 V, for fan coil units and universal applications

- KNX communications
- 3 multifunctional inputs for keycard contact, external room / return air temperature (QAH11.1, QAA32), heat / cool changeover, operation mode changeover, window contact on/off, dewpoint monitor, electrical heater enabled, fault contact
- Operating modes: Comfort, Economy and Protection
- 2-position, 3-position or PWM control outputs
- Automatic or manual fan speed for 1-speed, 3-speed fan
- Automatic or manual heating / cooling changeover
- Adjustable commissioning and control parameters
- Minimum and maximum setpoint limitation
- Backlit display

Application selectable:

- 2-pipe system
- 2-pipe system with electrical heater
- 2-pipe system and radiator / floor heating
- 4-pipe system
- 4-pipe system with electrical heater
- 2-stage heating or cooling system

Data sheet	N3191
Operating voltage	AC 230 V
Switching differential	Heating: 0.5...6 K Cooling: 0.5...6 K
Setpoint setting range	5...40 °C
Analog inputs, number	2
Digital inputs, number	1
Relay outputs, number	3
Relay outputs	Fan: 1- or 3-speed
Relay output, switching voltage	AC 230 V
Relay output, switching current	5 (4) A
Triac outputs, number	3
Triac outputs	Valve, el. heater 2-position, PWM, 3-position
Triac output, switching voltage	AC 230 V
Triac output, switching current	Max. 1 A
Type of fixing	Wall mounting with screws
Communication	Bus: KNX (S-Mode und LTE-Mode mit Synco 700)
Degree of protection	IP30
Dimensions (W x H x D)	93 x 128 x 30.8 mm

Stock No.	Product No.
S55770-T163	RDG100KN



RDG160KN



Room thermostat with KNX communications, AC 24 V, for fan coil units and universal applications, heat pump, fan (1-/ 3-speed, DC), valves (2-point, DC)

- KNX communications
- For applications with DC control outputs and DC or 3-speed fan output
- For applications with 2-position control output with DC fan output
- 3 multifunctional inputs for keycard contact, external room / return air temperature (QAH11.1, QAA32), heat / cool changeover, operation mode changeover, window contact on/off, dewpoint monitor, electrical heater enabled, fault contact
- Operating modes: Comfort, Economy and Protection
- Automatic or manual EC fan or 1-/3-speed
- Automatic or manual heating / cooling changeover
- Adjustable commissioning and control parameters
- Minimum and maximum setpoint limitation
- Backlit display

Application selectable:

- 2-pipe system
- 2-pipe system with electrical heater
- 2-pipe system and radiator / floor heating
- 4-pipe system
- 2-stage heating or cooling system

Data sheet	N3191
Operating voltage	AC 24 V
Switching differential	Heating: 0.5...6 K Cooling: 0.5...6 K
Setpoint setting range	5...40 °C
Analog inputs, number	2
Digital inputs, number	1
Relay outputs, number	3
Relay outputs	Valve, compressor or el. heater: 2 outputs, 2-position Fan: 1- or 3-speed
Relay output, switching voltage	AC 24...230 V
Relay output, switching current	5 (4) A
Analog outputs, number	3
Analog outputs	Valve, el. heater: 2 Fan: 1 (ECM)
Analog output, signal	DC 0...10 V
Type of fixing	Wall mounting with screws
Degree of protection	IP30
Dimensions (W x H x D)	93 x 128 x 30.8 mm
Communication	Bus: KNX (S-Mode und LTE-Mode mit Synco 700)

Stock No. Product No.

S55770-T297 RDG160KN

6

Room automation Synco
Communicating room thermostats
For fan coil units - Communicating KNX thermostat RDG.. / RDF..

Touch screen room thermostat with KNX communications, for 2-/4- pipe fan coil, universal applications or compressors in DX-type equipment

RDF800KN

Touch screen room thermostat for 2-/4-pipe fan coil, universal applications or compressors in DX-type equipment



- KNX communications
- Operating modes: Comfort, Economy and Protection
- For heating and/or cooling applications
- 2 or 3-position control outputs
- Output for 1-speed or 3-speed fan
- 2 multifunctional inputs for keycard contact, external room / return air temperature (QAH11.1, QAA32), heat / cool changeover, window contact on/off, dewpoint monitor, electrical heater enabled, fault contact, presence detector
- Automatic or manual heating/cooling changeover
- Adjustable commissioning and control parameters
- Minimum and maximum setpoint limitation
- Color of housing: Ivory white
- Backlit display

Application selectable:

- 2-pipe system
- 2-pipe system with electrical heater
- 4-pipe system

Data sheet	N3174
Operating voltage	AC 230 V
Switching differential	0.5...6 K
Setpoint setting range	5...40 °C
Analog inputs, number	2
Relay outputs, number	5
Relay outputs	Fan: N.O. contacts, non-floating Valve: N.O. contacts, non-floating
Relay output, switching voltage	AC 230 V
Relay output, switching current	5 (2) A
Type of fixing	With screws on recessed round conduit box diameter min. 60 mm
Degree of protection	IP30
Dimensions (W x H x D)	86 x 86 x 47 mm
Communication	Bus: KNX (S-mode and LTE mode with Synco 700)

Stock No. Product No.

S55770-T350 **RDF800KN**



RDF800KN/NF



Touch screen room thermostat with KNX communications, for 2-/4- pipe fan coil, universal applications or compressors in DX-type equipment (for China frames)

Touch screen room thermostat for 2-/4-pipe fan coil, universal applications or compressors in DX-type equipment (for China frames)

- KNX communications
- Operating modes: Comfort, Economy and Protection
- For heating and/or cooling applications
- 2 or 3-position control outputs
- Output for 1-speed or 3-speed fan
- 2 multifunctional inputs for keycard contact, external room / return air temperature (QAH11.1, QAA32), heat / cool changeover, window contact on/off, dewpoint monitor, electrical heater enabled, fault contact, presence detector
- Automatic or manual heating/cooling changeover
- Adjustable commissioning and control parameters
- Minimum and maximum setpoint limitation
- Color of housing: Ivory white
- Backlit display
- Mounting on chinese mounting frames

Application selectable:

- 2-pipe system
- 2-pipe system with electrical heater
- 4-pipe system

Data sheet	N3174
Operating voltage	AC 230 V
Switching differential	0.5...6 K
Setpoint setting range	5...40 °C
Analog inputs, number	2
Relay outputs, number	5
Relay outputs	Fan: N.O. contacts, non-floating Valve: N.O. contacts, non-floating
Relay output, switching voltage	AC 230 V
Relay output, switching current	5 (2) A
Type of fixing	Only on China frames
Degree of protection	IP30
Dimensions (W x H x D)	82 x 82 x 47 mm
Communication	Bus: KNX (S-mode and LTE mode with Synco 700)

Stock No. Product No.

S55770-T335

RDF800KN/NF

Room automation Synco
Communicating room thermostats
For fan coil units - Communicating KNX thermostat RDG.. / RDF..

Flush-mount room thermostats with KNX communications, 2-/4-pipe fan coils or DX type equipment

RDF..KNX Flush Mount



Flush-mount room thermostat with LCD for fan coil units and compressors in DX-type equipment

- KNX communications
- Operating modes: Comfort, Economy and Protection
- For heating and/or cooling applications
- 2 or 3-position control outputs
- Output for 1-speed or 3-speed fan
- 2 multifunctional inputs for keycard contact, external room / return air temperature (QAH11.1, QAA32), heat / cool changeover, operation mode changeover, window contact on/off, dewpoint monitor, electrical heater enabled, fault contact
- Automatic or manual heating/cooling changeover
- Adjustable commissioning and control parameters
- Minimum and maximum setpoint limitation
- Color of housing: signal white (RAL 9003)
- Backlit display

Application selectable:

- 2-pipe system
- 2-pipe system with electrical heater
- 4-pipe system

Data sheet	N3171
Operating voltage	AC 230 V
Setpoint setting range	5...40 °C
Analog inputs, number	2
Relay outputs, number	5
Relay outputs	Fan: N.O. contacts, non-floating Valve: N.O. contacts, non-floating
Relay output, switching voltage	AC 230 V
Relay output, switching current	5 (2) A
Type of fixing	Recessed rectangular conduit box BS4662 with fixing centres of 60.3 mm (ARG71)
Communication	Bus: KNX (S-mode and LTE mode with Synco 700)
Degree of protection	IP30
Dimensions (W x H x D)	86 x 86 x 57 mm

Range overview RDF..KNX Flush Mount

Product Title	Type of fixing	Stock No.	Product No.
Flush-mount room thermostat with KNX communications, 2-/4-pipe fan coils or DX type equipment	With screws on recessed round conduit box diameter min. 60 mm	S55770-T293	RDF600KN
Flush-mount room thermostat with KNX communications, 2-/4-pipe fan coils or DX type equipment	Recessed rectangular conduit box BS4662 with fixing centres of 60.3 mm (ARG71)	S55770-T104	RDF301
Flush-mount room thermostat with KNX communications, 2-/4-pipe fan coils or DX type equipment, four buttons for switching lights and blinds	Recessed rectangular conduit box BS4662 with fixing centres of 60.3 mm (ARG71)	S55770-T105	RDF301.50
Hotel Flush-mount room thermostat with KNX, 2-/4-pipe fan coils or DX type equipment, four buttons hotel functions	Recessed rectangular conduit box BS4662 with fixing centres of 60.3 mm (ARG71)	S55770-T334	RDF301.50H

RDG400KN



Room thermostat with KNX communications, AC 24 V, VAV heating and cooling systems

- KNX communications
- Output DC 0...10 V for VAV actuator and auxiliary output ON/OFF, PWM or 3-position or 3-position for VAV actuator and auxiliary output DC 0...10 V
- 2 multifunctional inputs for keycard contact, external room / return air temperature (1x, QAH11.1, QAA32), heat / cool changeover, operation mode changeover, window contact on/off, dewpoint monitor, electrical heater enabled, fault contact
- 1 input DC 0...10 V for damper position feedback
- Operating modes: Comfort, Economy and Protection
- Modulating PI control
- Control depending on the room or the return air temperature
- Automatic or manual heating / cooling changeover
- Adjustable commissioning and control parameters
- Minimum and maximum setpoint limitation
- Minimum and maximum limitation of air flow signal
- Output signal inversion (DC 0...10 V) as an option
- Backlit display

Application selectable:

- Single-duct system
- Single-duct system with electrical heater
- Single-duct system and radiator / floor heating
- Single-duct system with heating / cooling coil

Data sheet	N3192
Operating voltage	AC 24 V
Setpoint setting range	5...40 °C
Analog inputs, number	2
Analog input, signal	NTC 3k DC 0...10 V
Digital inputs, number	1
Analog outputs, number	1
Analog outputs	VAV actuator, electric heater, valve
Analog output, signal	DC 0...10 V
Analog output, current	Max. ±1 mA
Triac outputs, number	1
Triac outputs	VAV actuator, valve, el. heater 2-position, PWM, 3-position
Triac output, switching voltage	AC 24 V
Triac output, switching current	Max. 1 A
Type of fixing	Wall mounting with screws
Communication	Bus: KNX (S-mode and LTE mode with Synco 700)
Degree of protection	IP30
Dimensions (W x H x D)	93 x 128 x 30.8 mm

Stock No. Product No.

S55770-T165 **RDG400KN**

Room automation Synco
Communicating room thermostats
For VAV systems - Communicating KNX thermostat RDG.. / RDU..

Semi Flush-mount room thermostat for rectangular conduit box with KNX communications, for VAV application

RDU341



Semi Flush-mount room thermostat for VAV application

- KNX communications
- Output for a DC 0...10 V actuator and AC 230V electrical heater (ON-OFF)
- 2 multifunctional inputs for keycard contact, external room / return air temperature (QAH11.1, QAA32), heat / cool changeover, operation mode changeover, window contact on/off, dewpoint monitor, electrical heater enabled, fault contact
- Operating modes: Comfort, Economy and Protection
- Modulating PI control
- Control depending on the room or the return air temperature
- Automatic or manual heating/cooling changeover
- Adjustable commissioning and control parameters
- Minimum and maximum setpoint limitation
- Adjustable minimum and maximum limitation for air flow signal DC 0...10V
- Output signal inversion as an option

Application selectable:

- Single-duct system
- Single-duct system with electrical heater

Data sheet N3172

Operating voltage	AC 24 V
Setpoint setting range	5...40 °C
Analog inputs, number	2
Analog outputs, number	1
Analog output, signal	DC 0...10 V
Analog output, current	Max. ±1 mA
Relay outputs, number	1
Relay outputs	N.O. contact, potential-free
Relay output, switching voltage	AC 230 V
Relay output, switching current	Max. 5 (2) A
Type of fixing	Recessed rectangular conduit box BS4662 (ARG71) with fixing centres of 60.3 mm
Communication	Bus: KNX (S-mode and LTE mode with Synco 700)
Degree of protection	IP30
Dimensions (W x H x D)	86 x 86 x 57 mm

Stock No. Product No.

S55770-T106 **RDU341**



RDD810KN/NF



Touch screen room thermostat with KNX communications, for heating application (for China frames)

Touch screen room thermostat for heating application (for China frames)

- KNX communications
- Operating modes: Comfort, Economy and Protection
- Control output: changeover contact (SPDT)
- 2 multifunctional inputs for keycard contact, external room / return air temperature (QAH11.1, QAA32), window contact on/off, presence detector, fault contact, presence detector
- Adjustable commissioning and control parameters
- Minimum and maximum setpoint limitation
- Color of housing: Ivory white
- Backlit display
- Mounting on chinese mounting frames

Data sheet	N3175
Operating voltage	AC 230 V
Switching differential	0.5...6 K
Setpoint setting range	5...40 °C
Analog inputs, number	2
Relay outputs, number	1
Relay outputs	Heating: contacts, floating
Relay output, switching voltage	AC 24...230 V
Relay output, switching current	5 (2) A
Type of fixing	Only on China frames
Degree of protection	IP30
Dimensions (W x H x D)	82 x 82 x 47 mm
Communication	Bus: KNX (S-mode and LTE mode with Synco 700)

Stock No. Product No.

S55770-T336

RDD810KN/NF

6

Central control unit RMB795B for room controllers and room thermostats

RMB795B..



- Central control unit with integrated control and supervisory functions for individual room control with RXB and RXL room controllers and room thermostats RDG/RDF/RDU
- Central collection of heating and cooling demands from any KNX room controllers
- Control of any HVAC primary controllers in dependence on the received and calculated heating/cooling demands
- Individual time programs for room groups
- Preselected operating modes and setpoints, minimum / maximum temperature supervision and supervision of RXB/RXL room controllers and room thermostats RDG/RDF/RDU
- Operation and monitoring of individual RXB/RXL room controllers
- Trend and fault reporting functions for the input variables temperature, relative / absolute humidity, pressure / differential pressure, volumetric air flow, indoor air quality, etc.
- Heating / cooling changeover function for operation with 2-pipe systems
- Flexible configuration
- Functionality can be extended (extension modules)
- Clear-text operation with separate operator unit (plug-in type or detached)
- Integrated KNX bus communication
- No extra commissioning tool required

Extension modules complement the RMB795B central control unit and offer extra functions. The extension modules are attached to the RMB795B central control unit. Full operation from commissioning to enduser operation via operator unit.

Available extension modules:

- max. 1 universal module RMZ785
- max. 2 universal modules RMZ787

Available operator units:

- Plug-in type operator unit RMZ790

Data sheet	N3122
Operating voltage	AC 24 V
Frequency	50/60 Hz
Power consumption	12 VA
Universal inputs, number	6
Universal input, signal	0...1000 Ohm 1000...1175 Ohm 2 x LG-Ni1000 DC 0...10 V Potential-free digital status contact LG-Ni1000 Pt1000 T1 (PTC)
Analog outputs, number	2
Analog output, signal	DC 0...10 V
Analog output, current	Max. 1 mA
Relay outputs	Potential-free switching contact
Relay outputs, number	4
Relay output, switching voltage	AC 19...250 V
Relay output, switching current	4 (3) A
Communication	KNX (KNX TP1)

Room automation Synco

Central control unit RMB..

For room controller and room thermostats RXB.. / RXL.. / RDG.. / RDF.. / RDU..

Range overview RMB795B..

Product Title	Stock No.	Product No.
Central control unit RMB795B-1 with languages de, fr, it, es, pt	S55370-C162	RMB795B-1
Central control unit RMB795B-2 with languages de, fr, nl, en	S55370-C163	RMB795B-2
Central control unit RMB795B-3 with languages da, fi, no, sv	S55370-C164	RMB795B-3
Central control unit RMB795B-4 with languages cs, sk, pl, hu, ru, bg	S55370-C165	RMB795B-4
Central control unit RMB795B-5 with languages ro, sl, sr, hr, el, tr	S55370-C166	RMB795B-5
Central control unit RMB795B-6 with language zh	S55370-C167	RMB795B-6

Room automation Synco
Central control unit RMB..
Extension modules and operator units for RMB..

Operator units for RMB..

Product Title	Data sheet	Stock No.	Product No.
Plug-in type operator unit	N3111	BPZ:RMZ790	RMZ790
Detached operator unit with 3 m cable	N3112	BPZ:RMZ791	RMZ791

Extension modules for RMB..

Product Title	Data sheet	Stock No.	Product No.
Universal module (8UI)	N3146	BPZ:RMZ785	RMZ785
Universal module (4UI, 4DO)	N3146	BPZ:RMZ787	RMZ787
Module connector	N3138	BPZ:RMZ780	RMZ780

QAX3..

Room unit with PPS2 interface

Room units for acquiring the room temperature and operation of individual room control.

Power consumption	0.10 VA
Interface for controller	PPS2
Interface for service	PPS2 on RJ45
Sensing element, temperature	NTC
Measuring range, temperature	0...40 °C
Time constant	≤8 min
Measurement accuracy	±0.25 K at 25 °C ±0.5 K at 5...30 °C
Setpoint readjustment range	±12 K
Degree of protection	IP30
Mounting location	Indoors
Mounting	Directly on wall In recessed or top-mounted conduit box

QAX30.1

Room unit with sensor and PPS2 interface

- Acquisition of room temperature

Data sheet	N1741
Voltage supply	PPS2
Dimensions (W x H x D)	90 x 100 x 32 mm



Stock No.	Product No.
BPZ:QAX30.1	QAX30.1

QAX31.1

Room unit with sensor, setpoint adjuster and PPS2 interface

- Acquisition of room temperature
- Setpoint adjuster for room temperature

Data sheet	N1741
Dimensions (W x H x D)	90 x 100 x 36 mm



Stock No.	Product No.
BPZ:QAX31.1	QAX31.1

QAX32.1

Room unit with sensor, setpoint and operating mode selector and PPS2 interface

- Acquisition of room temperature
- Setpoint adjuster for room temperature
- Rocker switch for mode selection (Off / Auto)

Data sheet	N1641
Dimensions (W x H x D)	90 x 100 x 36 mm



Stock No.	Product No.
BPZ:QAX32.1	QAX32.1

Room automation Synco
Room operator units
For controllers RX.. (PPS2): QAX3.. / QAX8..

Room unit with sensor, setpoint and operating mode selector, fan speed selection, and PPS2 interface

QAX33.1

- Acquisition of room temperature
- Setpoint adjuster for room temperature
- Rocker switch for mode selection (Off/Auto) and for manual fan control with fan coil systems (up to 3 speeds)



Data sheet N1642
Dimensions (W x H x D) 90 x 100 x 36 mm

Stock No. Product No.
BPZ:QAX33.1 QAX33.1

Room unit with sensor, setpoint and operating mode selector, display and PPS2 interface

QAX34.1

- Acquisition of room temperature
- Rocker switch for adjustment of room temperature setpoint
- Rocker switch for mode selection (Off/Auto) and for manual fan control with fan coil systems (up to 3 speeds)
- LCD with display of room temperature and control mode



Data sheet N1645
Dimensions (W x H x D) 90 x 100 x 36 mm

Stock No. Product No.
BPZ:QAX34.1 QAX34.1

Room unit with sensor, setpoint and operating mode selector, display and PPS2 interface

QAX34.3

- Acquisition of room temperature
- Rocker switch for adjustment of room temperature setpoint
- Rocker switch for mode selection (Off/Auto) and for manual fan control with fan coil systems (up to 3 speeds)
- LCD with display of room temperature and control mode
- Together with the new RXB and RXL controllers for parameter setting



Data sheet N1640
Dimensions (W x H x D) 96 x 119 x 24 mm

Stock No. Product No.
BPZ:QAX34.3 QAX34.3

Universal setpoint adjuster with PPS2 interface

QAX39.1

- Setpoint adjuster for room temperature

Data sheet N1646
Dimensions (W x H x D) 48 x 48 x 15 mm



Stock No. Product No.
BPZ:QAX39.1 QAX39.1

6

Room automation Synco

Room operator units

For controllers RX.. (PPS2): QAX3.. / QAX8..

QAX84.1/PPS2



Flush-mounted room unit complete with PPS2 interface and design frame

The set consists of:

- Operator unit,
- PPS2 bus coupling unit and
- Design frame DELTA line in titanium white.

Functionality:

- Acquisition of room temperature
- Switch for adjustment of room temperature setpoint
- Switch for mode selection (Off/Auto) and for manual fan control with fan coil systems (up to 3 speeds)
- LCD with display of room temperature and control mode

Data sheet	N1649
Voltage supply	PPS2
Measuring range, temperature	0...40 °C
Sensing element, temperature	NTC
Mounting	Flush or wall-mounted conduit box
Degree of protection	IP30
Dimensions (W x H x D)	80 x 80 x 30.5 mm

Stock No.

Product No.

BPZ:QAX84.1/PPS2

QAX84.1/PPS2

QAW740



Room unit with KNX bus

Configurable unit with display of operating mode, timer, temperatures and fault.

With 3 operating elements:

- Knob for setpoint readjustments
- Operating mode button
- Timer button

Data sheet	N1633
Setpoint readjustment range	±3 K
Measuring range, temperature	0...50 °C
Communication	KNX TP1 EE
Connection cable	2-wire
Degree of protection	IP20
Dimensions (W x H x D)	96 x 96 x 47 mm

Stock No.	Product No.
-----------	-------------

BPZ:QAW740	QAW740
------------	--------

QMX3..

Wall-mounted room sensors and operator units for KNX

The wall-mounted room unit QMX3.. consists of:

- Base plate
- Sensor or room operator unit

The following functions are (depending on type):

- Temperature sensor or multisensor (T, r.h., CO2)
- Backlit display or LED display
- Touchkeys
- Switching and control of lighting, blinds, scenes

Data sheet	N1602
Measuring range, temperature	0...50 °C
Sensing element, temperature	NTC
Degree of protection	IP30
Mounting	Wall-mounting
Communication	KNX PL-Link KNX S-Mode
Dimensions (W x H x D)	88.4 x 133.4 x 18 mm

QMX3.P30

Room sensor KNX for temperature

Functions:

- Temperature sensor



Stock No.	Product No.
S55624-H103	QMX3.P30

QMX3.P70

Room sensor KNX for temperature, humidity, CO2

Functions:

- multisensor for temperature, humidity and CO2
- Air quality indicator with LED



Stock No.	Product No.
S55624-H104	QMX3.P70

Room operator unit KNX with temperature sensor, segmented backlit display, touchkeys

QMX3.P34

Functions:

- Temperature sensor
- Segmented backlit display and touchkeys



Stock No.

Product No.

S55624-H105

QMX3.P34

Room operator unit KNX with sensors for temperature, humidity, CO2, segmented backlit display, touchkeys

QMX3.P74

Functions:

- multisensor for temperature, humidity and CO2
- Segmented backlit display and touchkeys



Stock No.

Product No.

S55624-H106

QMX3.P74

Room operator unit KNX with temperature sensor, segmented backlit display, configurable touchkeys, LED display

QMX3.P37

Functions:

- Temperature sensor
- Segmented backlit display and touchkeys
- Configurable touchkeys with LED display
- Switching and control of lighting, blinds, scenes
- Window for labels



Stock No.

Product No.

S55624-H108

QMX3.P37



QAX95.4



Room unit with EnOcean interface

- Acquisition of the room temperature
- Powered by solar cell
- A gateway is mandatory (EnOcean / KNX)
- Optional use of battery if light conditions are insufficient
- Including design frame DELTA line, titan white

For use with units from the following product ranges:

- RXB (together with gateway EnOcean/KNX, RXZ97.1/KNX)
- Devices with KNX Communication

Data sheet	N1663
Voltage supply	Solar cell
Measuring range, temperature	0...50 °C
Measurement accuracy	±0.4 K
Time constant	≤16 min
Degree of protection	IP30
Dimensions (W x H x D)	55 x 55 x 19 mm
Weight	0.05 kg

Stock No. Product No.

S55623-H104 **QAX95.4**

6

QAX96.4



Room unit with EnOcean interface, setpoint adjuster

- Acquisition of the room temperature
- Room temperature setpoint adjustment
- Powered by solar cell
- A gateway is mandatory (EnOcean / KNX)
- Optional use of battery if light conditions are insufficient
- Including design frame DELTA line, titan white

For use with units from the following product ranges:

- RXB (together with gateway EnOcean/KNX, RXZ97.1/KNX)
- Devices with KNX Communication

Data sheet	N1663
Voltage supply	Solar cell
Measuring range, temperature	0...50 °C
Measurement accuracy	±0.4 K
Time constant	≤16 min
Setpoint readjustment range	±10 K
Degree of protection	IP30
Dimensions (W x H x D)	55 x 55 x 28 mm
Weight	0.05 kg

Stock No. Product No.

S55623-H105 **QAX96.4**

Room unit with EnOcean interface, setpoint adjuster, button and switch

QAX97.4

- Acquisition of the room temperature
- Room temperature setpoint adjustment
- Freely-programmable button
- Step switch (2 stages)
- Powered by solar cell
- A gateway is mandatory (EnOcean / KNX)
- Optional use of battery if light conditions are insufficient
- Including design frame DELTA line, titan white



For use with units from the following product ranges:

- RXB (together with gateway EnOcean/KNX, RXZ97.1/KNX)
- Devices with KNX Communication

Data sheet	N1663
Voltage supply	Solar cell
Measuring range, temperature	0...50 °C
Measurement accuracy	±0.4 K
Time constant	≤16 min
Setpoint readjustment range	±10 K
Degree of protection	IP30
Dimensions (W x H x D)	55 x 55 x 28 mm
Weight	0.05 kg

Stock No.	Product No.
S55623-H106	QAX97.4

Room unit with EnOcean interface, setpoint adjuster, button and switch for fan stages

QAX98.4

- Acquisition of the room temperature
- Room temperature setpoint adjustment
- Freely-programmable button
- Step switch (5 stages)
- Powered by solar cell
- A gateway is mandatory (EnOcean / KNX)
- Optional use of battery if light conditions are insufficient
- Including design frame DELTA line, titan white



For use with units from the following product ranges:

- RXB (together with gateway EnOcean/KNX, RXZ97.1/KNX)
- Devices with KNX Communication

Data sheet	N1663
Voltage supply	Solar cell
Measuring range, temperature	0...50 °C
Measurement accuracy	±0.4 K
Time constant	≤16 min
Setpoint readjustment range	±10 K
Degree of protection	IP30
Dimensions (W x H x D)	55 x 55 x 28 mm
Weight	0.05 kg

Stock No.	Product No.
S55623-H107	QAX98.4

Room automation Synco

Room operator units

For controllers RX.. (EnOcean): QAX9.. / RXZ9..

RXZ97.1/KNX



Radio frequency receiver with Gateway EnOcean/KNX

- Evaluation of up to 32 EnOcean channels
- With RXB, other EnOcean functions may also be integrated: switches, window contacts, motion detectors
- Other EnOcean functions (dimming, blinds, light sensors) can be realized in KNX systems
- Powered via KNX bus
- With internal antenna

Data sheet

N1662

Operating voltage

DC 24 V

Voltage supply

KNX bus

Power consumption

0.6 VA

Ambient temperature, operation

-5...45 °C

Ambient humidity, operation

5...93 % r.H.

Degree of protection

IP20

Dimensions (W x H x D)

71 x 71 x 27 mm

Weight

0.07 kg

Stock No.

Product No.

S55842-Z101

RXZ97.1/KNX

G..B181.1E/KN



VAV compact controller KNX

- Networked compact controller with KNX capability for plants with variable or constant air volume flow
- Integrated, highly precise differential pressure sensor, damper actuator and digitally configurable air volume controller
- Nominal torque 5 or 10 Nm, air damper rotation angle mechanically adjustable between 0 and 90°
- Configurable as single device per room or for cascade control with pressure ratio 1:1, positive pressure, or negative pressure
- Prewired with a 0.9 m connecting cable and a 0.9 m KNX bus cable

Data sheet	N3547
Angular rotation	90 °
Positioning time	150 s
Degree of protection	IP54
Dimensions (W x H x D)	71 x 158 x 61 mm

Range overview G..B181.1E/KN

Torque [Nm]	Operating voltage [V]	Air damper area [m²]	Communication	Power consumption [VA]	Stock No.	Product No.
5	AC 24	0.8	KNX S-Mode KNX LTE-Mode KNX PL-Link	3	S55499-D134	GDB181.1E/KN
10	AC 24	1.5	KNX S-Mode KNX LTE-Mode KNX PL-Link	3	S55499-D135	GLB181.1E/KN

Basic Documentation No.: P3547



SEM62..



Transformers

Transformer with housing, providing a reduction in voltage from AC 230 V to AC 24 V (output power 30 VA)

- Self-resetting fuse integrated on the primary side
- Secondary On/Off switch and replaceable fuse (SEM62.2 only)
- Plug-in screw terminals
- Two secondary output plug-in terminals

Data sheet	N5536
Frequency	50/60 Hz
Primary voltage	AC 230 V
Secondary voltage	AC 24 V
Power output	30 VA
Degree of protection	IP20
Dimensions (W x H x D)	114 x 106 x 57 mm
Mounting	On DIN rail With screws

Range overview SEM62..

Product Title	Stock No.	Product No.
Standard version	BPZ:SEM62.1	SEM62.1
Standard version incl. switch and exchangeable fuse on the secondary side	BPZ:SEM62.2	SEM62.2

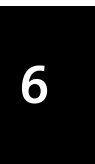

N 146/02



IP router

- LEDs for indicating that the device is ready-to-run, KNX communication, IP communication
- Electronics powered via an external nominal 24 V AC/DC power supply unit
- Power consumption at 24 V DC 57 mA
- Power supply for the electronics via "Power over Ethernet" according to IEEE 802.3af
- Integrated bus coupling units
- Bus connection via bus terminal
- Ethernet connection via RJ45 socket
- Plug-in terminal block for the connection of an external power supply unit
- Supports KNXnet/IP
- Line coupler function (Routing)
- 4 Interface functions (Tunneling)
- 1 Interface functions (object server)
- Modular installation devices for mounting on TH35 EN 60715 mounting rail

Data sheet	2.11.1.13
Voltage supply	Power over Ethernet or external SELV power supply AC/DC 24 V nominal
Operating voltage	AC 12...24 V DC 12...30 V
Dimension width (1 MW = 18 mm)	2 MW
Bus connection	Integrated bus coupling units Via bus terminal
Communication	Bus: KNX (S-mode and LTE mode) Ethernet, RJ45 socket

Stock No.	Product No.
5WG1146-1AB02	N 146/02

IP interface

N 148/22



- LEDs for indicating that the device is ready-to-run, KNX communication, IP communication
- Electronics powered via an external nominal 24 V AC/DC power supply unit
- Power consumption at 24 V DC, 57 mA
- Power supply for the electronics via "Power over Ethernet" according to IEEE 802.3af
- Integrated bus coupling units, Bus connection via bus terminal
- Ethernet connection via RJ45 socket
- Plug-in terminal block for the connection of an external power supply unit
- Supports KNXnet/IP
- 4 Interface functions (Tunneling)
- 1 Interface functions (object server)
- Modular installation devices for mounting on TH35 EN 60715 mounting rail

Data sheet	2.11.1.14
Voltage supply	Power over Ethernet
Operating voltage	AC 12...24 V DC 12...30 V
Dimension width (1 MW = 18 mm)	2 MW
Bus connection	Integrated bus coupling units Via bus terminal
Communication	Bus: KNX Ethernet, RJ45 socket

Stock No.	Product No.
5WG1148-1AB22	N 148/22

Room automation Synco
KNX accessories
KNX - System components

N 148/11



USB interface

- Electronics powered via bus voltage or via USB by a connected PC
- Integrated bus coupling units
- Bus connection via bus terminal or contact system to data rail
- Transmission PC – USB USB 1.1 or higher
- Electrically isolated access to the bus line via integrated socket USB (Typ B)
- Access to all bus devices in the system
- Modular installation devices for mounting on TH35 EN 60715 mounting rail

Data sheet	2.11.1.12
Voltage supply	USB KNX bus
Dimension width (1 MW = 18 mm)	1 MW
Bus connection	Integrated bus coupling units Via bus terminal Via data rail
Communication	Bus: KNX (S-mode and LTE mode) USB1.1



Stock No. Product No.

5WG1148-1AB11 **N 148/11**

6

Room automation Synco

KNX accessories

KNX - Power Supply Units

N 125/.2

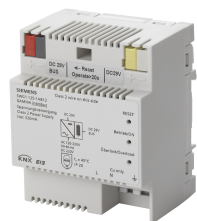

Power supply unit

- Integrated chokes
- Bus connection via bus terminal or contact system to data rail
- Rated operational voltage 120...230 V AC 50...60 Hz, 220 V DC
- Output voltage 29 V DC
- Additional unchoked output for 29 V DC, for powering a second bus line via an external choke (e. g. N 120/02)
- Modular installation devices for mounting on TH35 EN 60715 mounting rail

Data sheet	2.14.4.4
Operating voltage	AC 120...230 V DC 220 V
Dimension width (1 MW = 18 mm)	4 MW
Bus connection	Integrated choke Via bus terminal Via data rail

Range overview N 125

Product Title	Stock No.	Product No.
Power supply unit DC 29 V, 160 mA with additional unchoked output, N 125/02	5WG1125-1AB02	N 125/02
Power supply unit DC 29 V, 320 mA with additional unchoked output, N 125/12	5WG1125-1AB12	N 125/12
Power supply unit DC 29 V, 640 mA with additional unchoked output, N 125/22	5WG1125-1AB22	N 125/22

N 120/02



Choke, 640 mA

- For operation with a KNX power supply without integrated choke or for connection to the unchoked output of the KNX N 125/x2 power supplies
- Contact system for data rail
- Low-voltage terminal for unchoked voltage and bus
- Modular installation devices for mounting on TH35 EN 60715 mounting rail

Data sheet	2.14.2.2
Dimension width (1 MW = 18 mm)	2 MW
Bus connection	Integrated choke Via bus terminal Via data rail

Stock No.	Product No.
5WG1120-1AB02	N 120/02

Siemens Switzerland Ltd
Building Technologies Division
International Headquarters
Gubelstrasse 22
6301 Zug
Switzerland
Tel +41 41 724 24 24

The information in this document contains general descriptions of technical options available, which do not always have to be present in individual cases. The required features should therefore be specified in each individual case at the time of closing the contract. The document contains a general product overview. Availability can vary by country. For detailed product information, please contact the company office or authorized partners.

© Siemens Switzerland Ltd, 2015 • Order no. A55995-Q101

Our world is undergoing changes that force us to think in new ways: demographic change, urbanization, global warming and resource shortages. Maximum efficiency has top priority – and not only where energy is concerned. In addition, we need to increase comfort for the well-being of users. Also, our need for safety and security is constantly growing. For our customers, success is defined by how well they manage these challenges. Siemens has the answers.

“We are the trusted technology partner for energy-efficient, safe and secure buildings and infrastructure.”